

# Pro Tools Reference Guide

**Version 5.0.1 for Macintosh and Windows**

## **Digidesign Inc.**

3401-A Hillview Avenue  
Palo Alto, CA 94304 USA  
tel: 650-842-7900  
fax: 650-842-7999

## **Technical Support (USA)**

650-842-6699  
650-856-4275

## **Product Information (USA)**

650-842-6602  
800-333-2137

## **Fax on Demand (USA)**

1-888-USE-DIGI (873-3444)

## **World Wide Web**

[www.digidesign.com](http://www.digidesign.com)

## **Digidesign FTP Site**

[ftp.digidesign.com](ftp://ftp.digidesign.com)

**digidesign®**

A division of **Avid**

## **Copyright**

This User's Guide is copyrighted ©1999 by Digidesign, a division of Avid Technology, Inc. (hereafter "Digidesign"), with all rights reserved. Under copyright laws, this manual may not be duplicated in whole or in part without the written consent of Digidesign.

DIGIDESIGN, AVID and PRO TOOLS are trademarks or registered trademarks of Digidesign and/or Avid Technology, Inc. All other trademarks are the property of their respective owners.

All features and specifications subject to change without notice.

PN 932708002-00 REV A 05/00

# contents

---

## Part I Introduction

<b>Chapter 1. Welcome to Pro Tools</b> .....	3
The Pro Tools Guides .....	3
Compatibility Information .....	4
Digidesign Registration .....	4
<b>Chapter 2. Pro Tools System Configurations</b> .....	5
TDM-equipped systems .....	5
TDM System Playback, Recording and Voice Limits .....	6
Audio Interfaces for TDM Systems .....	6
Pro Tools LE Systems .....	7
Pro Tools LE System Capabilities .....	7
<b>Chapter 3. Pro Tools Concepts</b> .....	9
Hard Disk Recording .....	9
The Digidesign Audio Engine .....	9
Elements of a Session .....	10
MIDI Concepts .....	12
Virtual Tracks .....	14
<b>Chapter 4. Pro Tools Windows</b> .....	15
The Mix Window .....	15
The Edit Window .....	23
The Transport Window .....	33
Keyboard Focus .....	36

---

## Part II                    Pro Tools Sessions

<b>Chapter 5. Creating Sessions</b> .....	39
Starting Up Your System .....	39
Configuring Your System .....	39
Changing the Pro Tools Playback Engine .....	41
Changing DAE Playback Buffer Size .....	41
Creating a New Session .....	42
Opening a Session .....	45
Saving a Session .....	46
Creating Custom Session Templates .....	48
Closing a Session .....	50
Quitting a Session .....	50
Sharing Sessions between Pro Tools TDM Systems and Pro Tools LE Systems .....	50
<b>Chapter 6. Working with Tracks</b> .....	51
Creating Tracks .....	51
Hiding Tracks .....	52
Assigning Track Inputs .....	53
Assigning Track Outputs .....	54
Virtual Tracks, Voices, and Track Priority .....	54
Automatic Assignment of Ascending Voices .....	55
Assigning Voices and Track Priority .....	56
Setting MIDI Channels .....	59
Adjusting Track Volume and Pan .....	59
Soloing and Muting Tracks .....	60
Adjusting Track Width .....	61
Color Coding Tracks .....	62
Grouping Tracks .....	62
Using the Groups List .....	63
Enabling Grouping .....	64
Creating a Group .....	65

<b>Chapter 7. File Management and Compatibility</b> .....	67
Locating Audio Files .....	67
WAV File Compatibility .....	68
Naming Files, Playlists and Regions .....	69

---

## **Part III                   Recording**

<b>Chapter 8. Record Setup</b> .....	73
Input Connections and Audio Levels .....	73
Record Enabling Tracks .....	74
Monitoring Modes .....	75
Monitoring Latency .....	76
Low Latency Monitoring .....	77
Track Names .....	78
Recording to Multiple Hard Drives .....	79
Allocating Hard Drive Space for Recording .....	80
Record Modes .....	81
Recording with the Click .....	83
<b>Chapter 9. Basic Audio Recording</b> .....	87
Recording a Single Audio Track .....	87
Stereo and Multiple-Track Recording .....	89
Recording Additional Takes .....	90
Punch Recording Audio .....	92
Loop Recording Audio .....	93
Auditioning Record Takes .....	94
Setting Punch/Loop Points .....	96

<b>Chapter 10. MIDI Recording</b> .....	101
MIDI Controller Devices .....	101
Enabling Input Devices .....	102
MIDI Thru .....	103
MIDI Input Filter .....	103
Input Quantize .....	104
Wait for Note .....	104
MIDI Merge/Replace .....	105
Recording a MIDI Track .....	105
Punch Recording MIDI .....	107
Loop Recording MIDI .....	109
Recording System Exclusive Data .....	112
<b>Chapter 11. Advanced Recording</b> .....	113
Using QuickPunch .....	113
Recording from a Digital Source .....	116
Half-Speed Recording and Playback .....	118
<b>Chapter 12. Importing/Exporting Audio and MIDI</b> .....	119
Importing Audio .....	119
Importing Audio into a Session (Macintosh) .....	119
Importing Audio into a Session (Windows) .....	122
Recalculating Waveform Overviews .....	125
Loading Audio Files with Drag & Drop .....	125
Transferring Audio from CD .....	125
Conversion Quality .....	126
Exporting Audio .....	127
Importing MIDI Files .....	128
Exporting MIDI Files .....	129

---

## Part IV                      Editing

<b>Chapter 13. Editing Basics</b> .....	133
Pro Tools Editing .....	133
Track Material .....	134
Displaying Region Names and Times .....	137
Audio Regions and Waveforms .....	137
MIDI Regions and MIDI Data .....	139
Playlists .....	141
The Audio and MIDI Regions Lists .....	143
Edit Modes .....	145
Zooming .....	147
Rulers .....	149
Time Scale .....	150
Tick-Based Timing .....	152
<b>Chapter 14. Playing/Selecting Track Material</b> .....	155
Playing Tracks .....	155
Scrolling Options .....	157
The Scrubber .....	158
Separate Edit and Timeline Selections .....	161
Selecting Track Material .....	162
Playing Selections .....	170
Timeline Selections .....	171
Playing Edit and Timeline Selections with the Playhead .....	173

<b>Chapter 15. Working with Regions and Selections</b> .....	175
Creating New Regions .....	175
Healing a Separation .....	177
Placing Regions in Tracks .....	178
The Trimmer Tool .....	180
Moving Regions .....	182
Nudging .....	186
Shift Command .....	188
Quantizing Regions .....	189
Locking Regions .....	189
Muting/Unmuting Regions .....	190
Edit Commands .....	190
Duplicate Command .....	194
Repeat Command .....	194
Merge Paste Command .....	195
Consolidate Selection Command .....	196
Managing Regions .....	196
Compacting an Audio File .....	199
<b>Chapter 16. MIDI Editing</b> .....	201
Inserting MIDI Notes with the Pencil Tool .....	201
Manually Editing MIDI Notes .....	202
Continuous Controller Events .....	207
Program Changes .....	208
System Exclusive Events .....	211
MIDI Operations Window .....	212
Select Notes .....	213
Quantize .....	214
Change Velocity .....	219
Change Duration .....	221
Transpose .....	222
Note/Controller Chasing .....	223
MIDI Offset .....	224
Stuck Notes .....	225



<b>Chapter 17. Conductor Tracks and Memory Locations</b> .....	227
Tempo Events .....	227
Default Tempo .....	230
Identify Beat Command .....	230
Meter Events .....	233
Memory Locations and Markers .....	235
Memory Locations Window .....	242
<b>Chapter 18. Advanced Editing</b> .....	245
Using Crossfades .....	245
Creating Fades at the Beginnings and Ends of Regions .....	253
Creating Fades and Crossfades in Batches .....	255
Stripping Silence From Regions .....	256
Inserting Silence .....	258
The Time Trimmer .....	258
Compress/Expand Edit To Play .....	260
Repeat Paste To Fill Selection .....	260
Replacing Regions .....	261
Processing Audio with AudioSuite Plug-Ins .....	263
Waveform Repair with the Pencil Tool .....	263

---

## **Part V            Mixing**

<b>Chapter 19. Basic Mixing</b> .....	267
Creating Inserts and Sends .....	267
Inserts .....	268
Sends .....	271
Auxiliary Inputs .....	273
Master Faders .....	275

<b>Chapter 20. Advanced Mixing</b> . . . . .	277
Hardware I/O Inserts and Sends . . . . .	277
Creating a Submix . . . . .	280
Using an Auxiliary Input to Mix an External Source . . . . .	281
Creating a Master Send Level Control . . . . .	281
Printing Effects to Disk . . . . .	282
Recording a Submix to Disk . . . . .	282
TDM Mixer Plug-Ins . . . . .	283
<b>Chapter 21. Automation</b> . . . . .	287
Automation Modes . . . . .	288
Automation Preferences . . . . .	291
Viewing Automation . . . . .	293
Writing Automation . . . . .	294
Enabling or Suspending Automation . . . . .	297
Deleting Automation . . . . .	298
Thinning Automation . . . . .	299
Drawing Automation . . . . .	300
Editing Automation . . . . .	301
Writing Automation to the Start, End or All of a Selection . . . . .	306
Trimming Automation . . . . .	307
Creating Snapshot Automation . . . . .	308
Setting the Automation Buffer Size . . . . .	311
<b>Chapter 22. Mixdown and Mastering</b> . . . . .	313
Bouncing Tracks to Disk . . . . .	313
Bounce Parameters . . . . .	314
Output Options . . . . .	315
Using Dither on an Output Mix . . . . .	321
Creating a Submix . . . . .	322
Final Mixdown . . . . .	323
Mastering . . . . .	323

---

## Part VI                      Synchronization

<b>Chapter 23. Synchronization Concepts</b> .....	329
Your Sync Requirements .....	329
Aspects of Sync .....	329
Syncing Pro Tools .....	330
SMPTE Frame Formats .....	332
Working with Film-Originated Material.....	333
<b>Chapter 24. Time Code Synchronization</b> .....	339
Pro Tools Sync Options .....	339
The Session Setup Window .....	340
Preparing to Work with SMPTE.....	343
Configuring Pro Tools for SMPTE.....	343
Putting Pro Tools Online.....	346
Generating Time Code.....	347
Syncing a Sequencer to Pro Tools on the Macintosh .....	349
Syncing a Sequencer to Pro Tools in Windows .....	351
Using MIDI Machine Control .....	351
Remote Track Arming .....	353
Syncing Pro Tools to an OMS-Compatible Sequencer using MMC .....	355
MIDI Beat Clock .....	358
Spotting Regions to SMPTE Frame Locations .....	358
Time Stamping .....	361
Identifying a Sync Point .....	362
Troubleshooting Sync.....	363

<b>Chapter 25. Working with QuickTime Movies</b> . . . . .	367
About QuickTime . . . . .	367
QuickTime Requirements . . . . .	369
Movie Playback Quality Options . . . . .	369
Importing a QuickTime Movie . . . . .	370
Setting the Movie Start Time: Movie Offset . . . . .	372
Spotting Audio to a QuickTime Movie . . . . .	373
Importing QuickTime Audio . . . . .	374
Bouncing to a new Movie . . . . .	376
<b>Appendix A. DSP-Induced Delays in Mixing</b> . . . . .	379
Delay Factors . . . . .	379
Compensating for Delays . . . . .	380
Typical Delay Scenarios . . . . .	382
<b>Appendix B. TDM Mixing and DSP Usage</b> . . . . .	383
Pro Tools TDM Technology . . . . .	383
DSP Allocation . . . . .	383
DSP Usage with TDM Mixers . . . . .	386
DSP Usage with TDM Plug-Ins . . . . .	388
DSP Usage and I/O Allocation . . . . .	388
<b>Appendix C. Keyboard Shortcuts</b> . . . . .	389
Global Key Commands . . . . .	389
Commands Key Focus . . . . .	390
Numeric Keypad Modes . . . . .	390
<b>Appendix D. Troubleshooting</b> . . . . .	393
Backing up your work . . . . .	393
Common Issues . . . . .	393
Using DigITest As a Diagnostic Tool . . . . .	396
Performance Factors . . . . .	396
Before You Call Digidesign Technical Support . . . . .	397

# **Part I**

## **Introduction**



## chapter 1

# Welcome to Pro Tools

Welcome to Pro Tools®. Pro Tools integrates powerful multitrack digital audio and MIDI sequencing features, giving you everything you need to record, arrange, edit, mix, and master professional-quality audio.

---

## The Pro Tools Guides

Your Pro Tools System includes the following guides:

**Pro Tools Installation Guides** Instructions for installing Pro Tools software and hardware, and connecting your studio.

**Pro Tools Reference Guide** Instructions for creating sessions, recording, editing, and mixing with Pro Tools.

**DigiRack™ Plug-Ins Guide** Instructions for using the DigiRack Plug-Ins for both real-time and file-based audio processing in Pro Tools.

**Pro Tools MIDI Controllers Guide** Instructions for operating Pro Tools with various MIDI control surfaces.

## Quick Reference Cards (TDM Systems only)

Separate cards for Macintosh and Windows that list the many keyboard shortcuts not shown in the Pro Tools menus.

---

\* Online PDF versions of the Quick Reference cards are included for Pro Tools LE systems.

---

## Conventions Used in These Guides

The Pro Tools guides use the following conventions to indicate menu choices and key commands:

Convention	Action
File > Save Session	Choose Save Session from the File menu
Control+N	Hold down the Control key and press the <i>N</i> key
Option-click	Hold down the Option key and click the mouse button
Right-click (Windows)	Click with the right mouse button

The following symbols are used to highlight important information:

---

\* *User Tips* are helpful hints for getting the most from your Pro Tools system.

---

▲ *Important Notices* include information that could affect your Pro Tools session data or the performance of your Pro Tools system.

---

☞ *Cross References* point to related sections in the Pro Tools Guides.

---

### **Choose and Select**

The words “choose” and “select” are often interchangeable in conversational english. In this guide, however, there is a distinction between the two terms.

**Select** When the guide instructs you to *select* something, it stays selected. This is the case with dialog box options and menu items that enable or disable an option.

**Choose** When the guide instructs you to *choose* something, a one-time action is performed. This is the case with most menu commands; they perform their chosen action only once.

---

## **Compatibility Information**

Digidesign can only assure compatibility and provide support for devices it has tested and approved. For a list of Digidesign-qualified computers, SCSI accelerator cards, hard drives, diskette drives, and serial port adapters, refer to the latest compatibility information on the Digidesign Web site ([www.digidesign.com](http://www.digidesign.com)).

---

## **Digidesign Registration**

Make sure to complete and return the registration card included with Product Name. Registered users are entitled to one year of free technical support, and will receive periodic software updates and upgrade notices.



# Pro Tools System Configurations

---

## TDM-equipped systems

Pro Tools TDM-equipped systems are available in the following configurations:

### Pro Tools 24 MIXplus

A core system includes:

- MIX Core card
- MIX Farm card
- Pro Tools software
- Digidesign Audio Interface (sold separately)

### Pro Tools 24 MIX

A core system includes:

- a MIX Core card
- Pro Tools software
- Digidesign Audio Interface (sold separately)

### Pro Tools 24

A core system includes:

- d24 Audio card
- DSP Farm card
- Pro Tools software
- Digidesign Audio Interface (sold separately)

### Pro Tools III PCI (Macintosh only)

A core system includes:

- a Disk I/O Audio Card
- a DSP Farm Card
- Pro Tools software
- Digidesign Audio Interface (sold separately)

## Supported Audio Interfaces

You can use the following Audio Interfaces with Pro Tools TDM systems:

- ◆ The 888/24 I/O and 882/20 I/O (as well as 888 I/O and 882 I/O) Audio Interfaces work with Pro Tools 24 MIX/MIXplus, Pro Tools 24, or Pro Tools III PCI systems.
- ◆ The 1622 I/O Audio Interface works with Pro Tools 24 MIX/MIXplus and Pro Tools 24 systems only.
- ◆ The ADAT Bridge I/O Interface works with Pro Tools 24 MIX/MIXplus, Pro Tools 24, or Pro Tools III PCI systems.

---

▲ Pro Tools system performance depends on factors such as computer processor speed, amount of system memory, and hard drive performance. Contact your Digidesign dealer or visit Digidesign's Web site for the latest system requirements and compatibility information.

---

---

## TDM System Playback, Recording and Voice Limits

The following table lists the audio playback, recording, and voice limits of each type of Pro Tools TDM system. The term *virtual voice* refers to the maximum number of audio tracks that can share the available voices on your system. TDM-equipped Pro Tools systems can open sessions with up to 128 audio tracks, but any audio tracks beyond that system's virtual voice limit will be automatically set to *Voice Off*.

All TDM-equipped Pro Tools systems provide a total of 32 internal mix busses. TDM systems also provide 5 Inserts and 5 Sends per track, up to the DSP capacity of your system.

**Table 1. Pro Tools TDM System Audio Playback, Recording and Virtual Voice Limits**

Core System Type	Voices (Tracks of Simultaneous Playback)	Tracks of Simultaneous Recording	Virtual Voices
Pro Tools 24 MIX/MIXplus	32 or 64	32 or 64	86
Pro Tools 24	32	32	43
Pro Tools III (PCI)	16	16	53

---

## Audio Interfaces for TDM Systems

The following table lists the input and output capabilities of the various Audio Interfaces for TDM-equipped Pro Tools systems. In expanded TDM systems, Audio Interfaces can be combined for up to 72 audio inputs and outputs.

**Table 2. Pro Tools Audio Interface Channel Capabilities**

Interface Type	Number of I/O Channels	A/D Conversion	D/A Conversion	Digital I/O
888/24 I/O	8 in/8 out	24-bit	24-bit	24-bit
882/20 I/O	8 in/8 out	20-bit	20-bit	24-bit
888 I/O	8 in/8 out	18-bit	18-bit	24-bit
882 I/O	8 in/8 out	18-bit	18-bit	24-bit
1622 I/O	16 in/2 out	20-bit	20-bit	24-bit
ADAT Bridge I/O	16 in/16 out	20-bit	20-bit	24-bit

---

## Pro Tools LE Systems

Pro Tools LE-based systems are available in the following configurations.

### Digi 001

A Digi 001 system includes:

- Digi 001 PCI card
- Digi 001 I/O box
- Pro Tools LE software

### Pro Tools with Audiomedia III

An Audiomedia III system includes:

- Audiomedia III card
- Pro Tools LE software

---

▲ The total track count and processing capacity of Pro Tools LE-based systems depend on the processing power of your computer. Contact your Digidesign dealer or visit Digidesign's Web site for the latest system requirements and compatibility information.

---

---

## Pro Tools LE System Capabilities

The following table lists the playback, recording, and input/output capabilities of each Pro Tools LE-based system. All Pro Tools LE systems are limited to 24 audio tracks. If you open a Pro Tools session containing more than 24 audio tracks on an LE-based system, only the first 24 audio tracks will open; if you save the session using Pro Tools LE, any audio tracks beyond the first 24 will be lost.

All Pro Tools LE systems provide a total of 16 internal mix busses. Pro Tools LE also provides up to 5 Inserts and 5 Sends per track, depending on your computer's processing capacity.

*Table 3. Pro Tools LE System Audio Playback, Recording, and Channel Capabilities*

System Type	Tracks of Simultaneous Playback	Number of Recording/Playback Channels	A/D Conversion	D/A Conversion	Digital I/O
Digi 001	24	up to 18 in/18 out	24-bit	24-bit	24-bit
Audiomedia III	24	up to 4 in/4 out	18-bit	18-bit	24-bit

For details on transferring session material between Pro Tools LE and Pro Tools TDM systems, see "Sharing Sessions between Pro Tools TDM Systems and Pro Tools LE Systems" on page 50.



## chapter 3

# Pro Tools Concepts

This chapter is an overview of some essential concepts related to digital audio, MIDI, and digital signal processing as they apply to Pro Tools.

---

### Hard Disk Recording

Tape-based recording is a *linear* medium—you need to rewind or fast forward a tape to hear a particular spot in a recording. To rearrange or repeat material in a linear system, you need to re-record it.

Hard disk recording is a *non-linear* (or random access) medium—you can go immediately to any spot in a recording without having to rewind or fast forward.

Non-linear systems have several advantages. You can easily rearrange or repeat parts of a recording by making the hard disk read parts of the recording in a different order. In addition, this re-arrangement is *non-destructive*, meaning that the original recorded material is not altered.

Pro Tools is a non-linear recording system that allows you to rearrange and mix recorded material non-destructively.

---

### The Digidesign Audio Engine

When you start Pro Tools, an application called *DAE* automatically launches in the background. DAE, or the *Digidesign Audio Engine*, is Digidesign's real-time operating system for digital recording systems. When you install Pro Tools, DAE is automatically installed on your system.

In the same way that a computer's operating system provides the foundation for programs that run on the computer, DAE provides much of the hard disk recording, digital signal processing, mix automation, and MIDI functionality required by Pro Tools and other products from Digidesign and its Development Partners.

---

## Elements of a Session

When you start a project in Pro Tools, you create a *session*. Some basic elements of sessions are explained in this section.

### Session File



*Pro Tools session file icon*

A *session file* is the document that Pro Tools creates when you start a new project. The session file contains maps of all elements associated with a project, including audio files, MIDI data, and all your edit and mix information. You can make changes to a session and save those changes in a new session file. This allows you to create multiple versions of a project or back up your editing and mixing work.

### Audio File



*Audio file icon*

When you record audio into a Pro Tools session, audio files are created and stored in a folder named “Audio Files.” Audio files can appear in a session as regions, in a track or in the Audio Regions List.

### Region

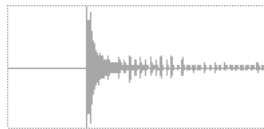

*Audio region*

A *region* is a piece of audio, MIDI, or automation data. An audio region could be a guitar riff, a verse of a song, a sound effect, a piece of dialog, or an entire sound file. In Pro Tools, regions are created from audio or MIDI files, and can be arranged in tracks.

### Playlist



*Playlist selector pop-up menu*

A *playlist* is a group of regions arranged on an Audio or MIDI track. You can place multiple edit playlists on a single track. This allows you to assemble different versions of a track and choose among them with a pop-up menu on the track.

On Audio tracks, a playlist tells the hard disk which audio files to read in what order. By using several copies of an audio region in a playlist, you can repeat a section of a recording without using any additional disk space.

## Track



Audio track in the Edit Window

A *track* is where audio or MIDI regions are strung together in a playlist. A playlist can be made up of a single region or many separate regions. It can be made up of similar elements, such as regions from several different takes of a solo, or dissimilar elements, such as several sound effects.

## Voice

(TDM Systems Only)



Choosing a voice for an Audio track

On TDM-equipped Pro Tools systems, *voice* refers to the number of digital audio events that Pro Tools can play back simultaneously. For example, a Pro Tools 24 core system is a 32-voice system and can therefore playback 32 different audio events at one time.

On TDM systems, you can have more tracks in a session than your system has voices; they just cannot all play back at the same time. These tracks are referred to as *virtual* tracks.

## Channel

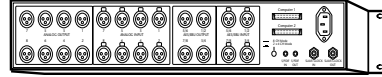

Rear view of 888/24 I/O Interface

The term *channel* is used to describe several related components of a Pro Tools system. The first refers to a physical input or output of your Pro Tools system. For example, an 888/24 I/O Audio Interface provides 8 channels of analog input and output to a TDM-equipped system, and a Digi 001 system provides up to 18 channels of input and output to a Pro Tools LE system.



Channel strip from the Mix window

The second use of the term *channel* refers to a mixer strip in the Pro Tools Mix window. The term *channel strip* refers to the mixer strip of any Audio track, MIDI track, Auxiliary Input track or Master Fader track in a session.

Audio and MIDI channel strips have similar controls, but those controls have slightly different effects. For example, Audio and Auxiliary Input channel strip faders control the Pro Tools mixer, while MIDI channel strip faders send MIDI volume data (MIDI controller 7).

The term *channel* also describes an aspect of MIDI operation. See “MIDI Concepts” on page 12.

## Playback Engine

All Pro Tools systems allow you choose the *Playback Engine* for a session at any time.

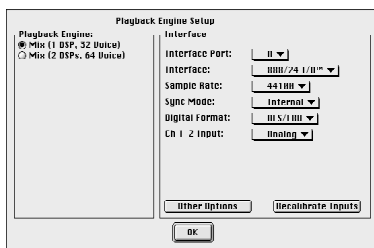

*Playback Engine dialog for Pro Tools TDM system*

The Playback Engine allows you to reconfigure Pro Tools to use different Digidesign hardware.

For details on choosing a Playback Engine, see “Configuring Your System” on page 39.

---

## MIDI Concepts

MIDI (Musical Instrument Digital Interface) is a communication protocol for musical instruments. This industry standard enables connections between a variety of devices from different manufacturers. Examples of MIDI-compatible equipment include synthesizers, sound modules, drum machines, patch bays, effects processors, MIDI interfaces, and sequencers.

MIDI devices are equipped with 5-pin DIN connectors, labeled as either IN, OUT, or THRU.

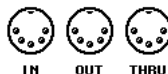

### MIDI Connectors

The MIDI OUT port transmits messages; the MIDI IN port receives messages; and, MIDI THRU echoes whatever is received from the IN port. MIDI devices are connected with MIDI cables that are available at most music stores.

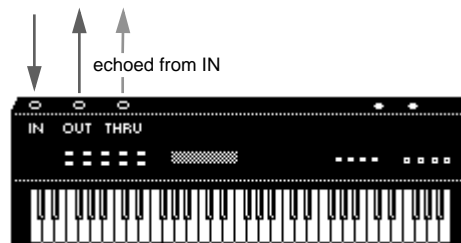

*MIDI signal flow*

---

▲ Not all devices will have all three MIDI ports (IN, OUT and THRU).

---



A single MIDI cable can transmit a separate set of messages for each of 16 channels. These 16 channels correspond to separate MIDI devices or to multiple channels within a single device (if the device is *multi-timbral*). Each channel represents a discreet instrument sound; for instance, bass on channel 1, piano on channel 2 and drums on channel 10. Similar to a multitrack tape recorder, a MIDI sequencer can record complex arrangements—even using a single multi-timbral keyboard.

## MIDI Terms

The following are some basic MIDI terms:

**MIDI Interface** Hardware that allows computers to connect to and communicate with MIDI devices.

**MIDI Device** Any keyboard, sound module, effects device or other equipment that can send or receive MIDI information.

**MIDI Controller** Any MIDI device that transmits MIDI performance data. These include keyboards, MIDI guitar controllers, MIDI wind instruments, and others. Controllers transmit MIDI from their MIDI OUT ports.

**MIDI Control Surface** Any device, such as the Mackie HUI, that uses a MIDI connection to send control messages to a software program, but is not generally used to record MIDI information.

**MIDI Sound Source** Any MIDI instrument that plays back in your arrangements. Sound sources receive MIDI from their MIDI IN ports.

**Multi-timbral** The capability of playing several different instrument sounds (such as piano, bass, and drums) simultaneously on

separate channels. This makes it possible for a single MIDI sound source to play back entire arrangements.

**MIDI Channel** Up to 16 channels of MIDI performance data can be transmitted on a single MIDI cable. The channel number separates the different messages so your sound sources can receive the right ones.

**Program Change Event** A MIDI command that tells a sound source which sound patch to use. The MIDI protocol lets you choose from a range of 128 patches.

**Bank Select Message** A MIDI command that specifies the bank of patches from which to choose. Many devices have more than 128 patches and Bank Select messages provide a means of accessing them.

**Local Control** A controller setting found on most MIDI keyboards that allows them to play their own sound source. Disabling “local control” ensures that a device’s internal sound source is only played by external MIDI messages.

When using Pro Tools, “local control” should usually be disabled. When “local control” is off, your keyboard still transmits data to its MIDI OUT port.

**Continuous Controller Events** MIDI instructions that allow real-time changes to notes that are currently sounding. These include pitch bend, modulation, volume, pan, and many others.

**System Exclusive Data** MIDI data commonly used for sending and retrieving patch parameter information for storage purposes.

## Common Misconceptions about MIDI

MIDI is not audio. The messages that travel down a MIDI cable are only numbers that translate to specific instructions. For instance, when you strike a key on your MIDI keyboard it sends a message to its MIDI OUT port telling another device (if connected and set to the same MIDI channel) to play that particular note.

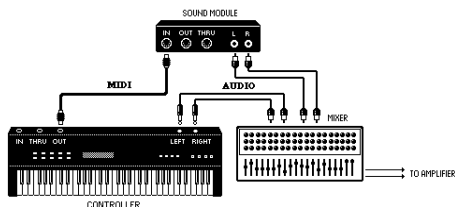

### Signal paths for MIDI instruments

However, to actually hear that second device (sound source) you'll need to connect its audio outputs to a sound system. Your MIDI instruments have two signal paths, one for audio and another for MIDI.

MIDI does not allow you to use your devices beyond their capabilities. Particular instruments have their own sound generation, polyphony, and multi-timbral limitations.

---

## Virtual Tracks

### (TDM Systems Only)

Tape decks record only *physical* tracks: they are limited by the number of tracks on the deck and on the tape itself. For example, a 16-track recorder can record and play back a maximum of 16 tracks at a time.

Pro Tools TDM systems are not limited by the number of physical inputs and outputs. Pro Tools TDM systems provide up to 128 *virtual* audio tracks that can be recorded upon and cued up for playback, but cannot all be played back simultaneously.

Virtual tracks provide significant advantages: on Pro Tools TDM systems, you can have many more *tracks* than *voices* in a session. You can then choose which of these tracks you want to play, up to the total number of available voices. You never need to erase tracks to make room for other tracks—provided that you have enough space available on your hard disk to store all of them. In addition, virtual tracks allow you to create separate tracks for each audio component of your mix, each with its own volume, pan, EQ, effects sends, and automation.

Pro Tools voices are *dynamically allocated*. When a hole opens up in one track, its voice becomes temporarily available and another track can pop through and begin to play. If the first track reaches a point where audio occurs again, the voice reverts to the original track. You can determine the order in which your tracks use available voices. See “Assigning Voices and Track Priority” on page 56.

Virtual tracks use the Digital Signal Processing (DSP) capacity of your system. (See “DSP Allocation” on page 383 for more information.) Another powerful Pro Tools feature, *multiple edit playlists*, allows you to create comps and alternate arrangements of material, but does not use additional DSP capacity. For details about multiple edit playlists, see “Playlists” on page 141.

## chapter 4

# Pro Tools Windows

Pro Tools provides two complementary ways of viewing a project: the Mix window and the Edit window. Pro Tools also allows you to control many functions from the Transport window. The main elements of these windows are explained in the following sections.

---

## The Mix Window

In the Mix window, tracks appear as mixer modules, with controls for inserts, sends, input/output assignments, volume, panning (in Stereo Mix mode), record-enable, automation mode, and solo/mute. The following section explains each of these track controls.

To display the Pro Tools input/output controls, inserts, sends, and comments, select **Display > Mix Window Shows > All**.

---

\* To toggle between the Mix and Edit windows, press **Command + =** (Macintosh) or **Control + =** (Windows).

---

## The Show/Hide Tracks List

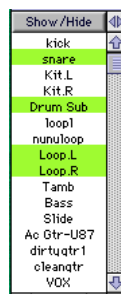

### Show/Hide Tracks List

This scrolling window lists all tracks in the current session. It allows you to show or hide a track by selecting or deselecting its name in its list. You can also use this list to reorder tracks on screen by dragging a track name to a new position within the list. The pop-up menu at the top of this list provides commands that allow you to show or hide all tracks, or only tracks currently selected on screen.

### About Groups and Show/Hide Tracks

Even if a track is hidden, if it is a member of an enabled group, all Mix window operations performed on other members of the group *will also affect the hidden track*—with the exception of audio or MIDI record-enabling. If you solo, mute, or automation

write-enable a grouped track, any group members that are hidden will be soloed, muted, or automation write-enabled as well. The only exception to this rule is record enabling of Audio or MIDI tracks. These functions are not applied to hidden tracks in the Mix window.

In the Edit window, however, editing operations performed on members of an enabled group will *not* affect hidden tracks that are also members of the enabled group.

On TDM systems, even if a track is hidden from view, its position relative to other tracks still affects its virtual track playback priority (see “Virtual Tracks, Voices, and Track Priority” on page 54 for details).

## The Mix Groups List

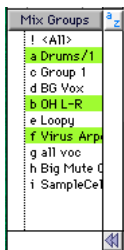

Mix Groups List

The Mix Groups list shows all groups in the session. It allows you to activate a group by selecting its name in the list. A group is only *enabled* (meaning that its members are linked for mixing purposes), when its name is highlighted in this list.

You can also use this list to select grouped tracks on-screen by clicking to the left of the dotted vertical line next to a group

name. The pop-up menu at the top of this list provides commands to create, delete or suspend groups. You can link groups in the Mix Groups and Edit Groups lists. For more information on grouping, see “Grouping Tracks” on page 62.

## An Audio Track/Channel Strip

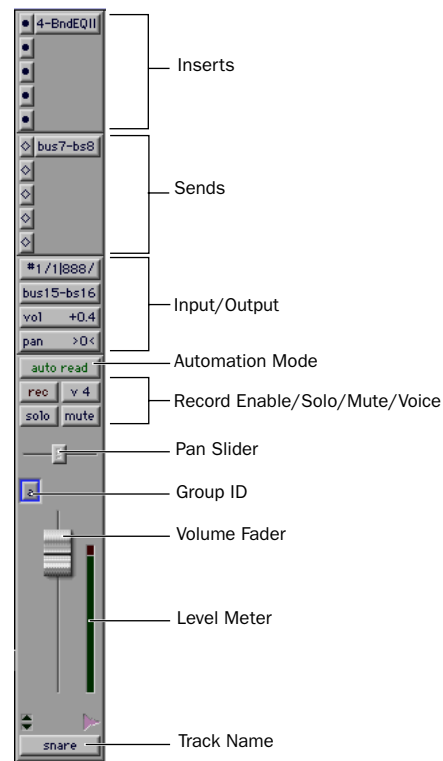

Audio Channel Strip

Each Audio track has its own set of controls for volume, pan, record-enable, automation mode, solo, mute, and on TDM systems, voice assignment.

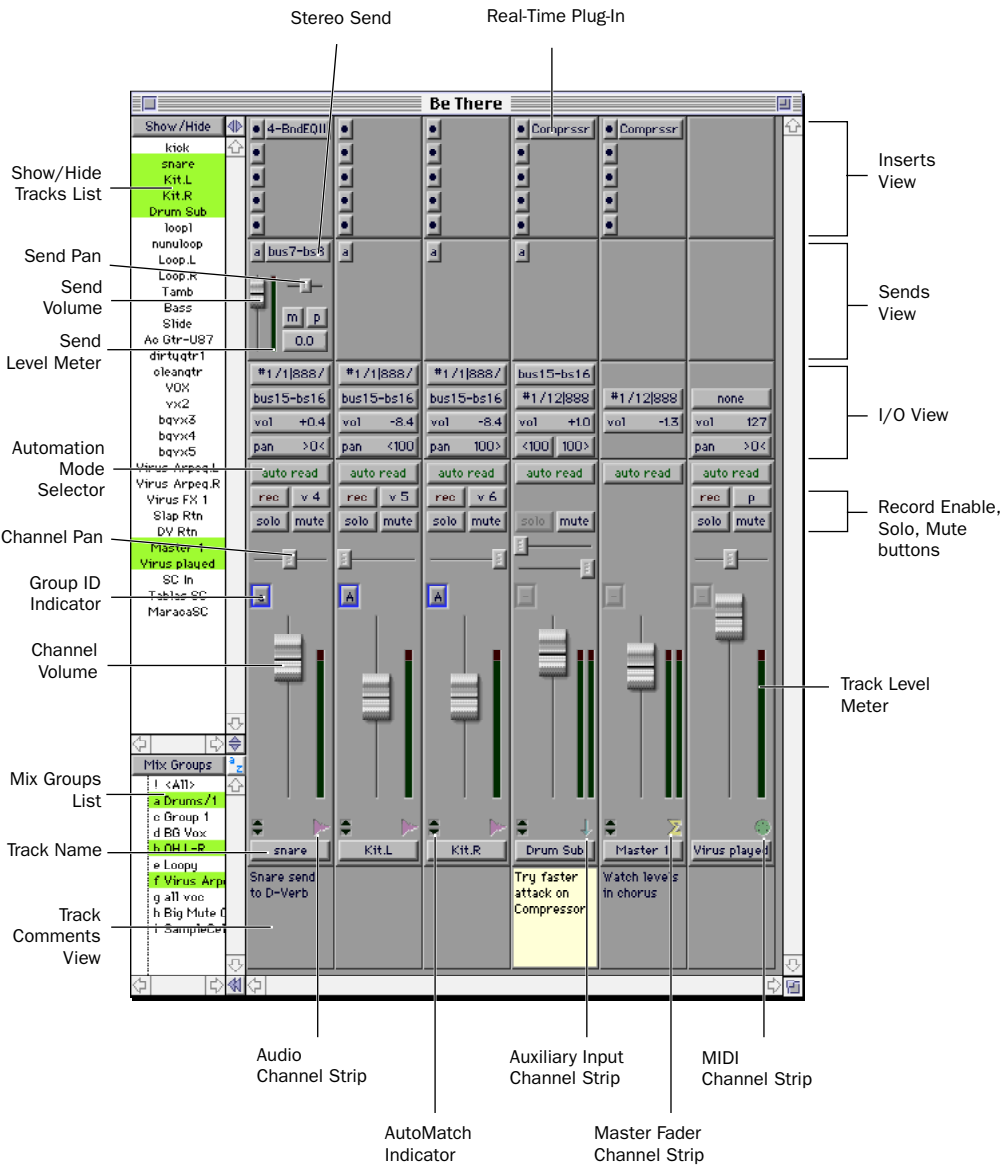
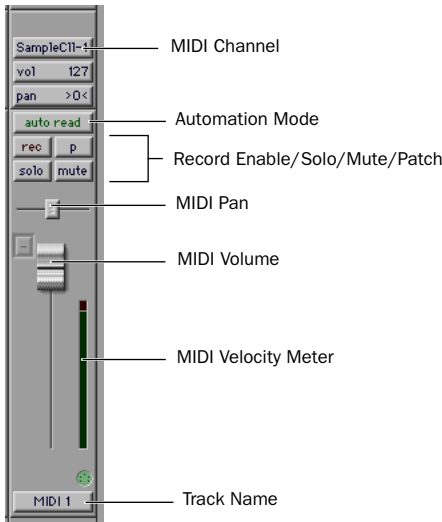

Figure 1. Pro Tools Mix Window

## A MIDI Track/Channel Strip



### MIDI Channel Strip

Each MIDI track has its own set of controls for volume, pan, record enable, automation mode, solo, mute, MIDI patch assignment, and MIDI channel assignment. MIDI tracks can be added to a session with the New Track command. Tracks can be added to a session with the New Track command. You can display tracks in Narrow or Normal width by selecting Display > Narrow Mix Window.

## Mix Window Track Controls

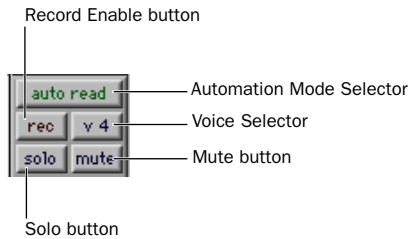

### Mix window track controls in channel strip

### Record Enable Button

The Record Enable button puts the track into record-ready mode. Once a track is record-enabled, click the Record and Play buttons in the Transport window to start audio or MIDI recording.

When the Latch Record Enable Buttons option is selected, you can record enable more than one track at the same time by clicking the record enable button on each track. If the Latch Record Enable Buttons option is deselected, Shift-click to record enable multiple tracks.

### Record Safe Mode

Pro Tools provides a *record safe* mode which allows you to disable recording capability on any track in a session. This prevents you from inadvertently record-enabling a track and then recording over valuable material. To toggle Record Safe mode, Command-click (Macintosh) or Control-Click (Windows) the Record button on the track.

### Solo Button

The Solo button mutes all other tracks so a track can be auditioned alone.

When the Latch Solo Buttons option is selected, you can solo more than one track at the same time simply by clicking the solo button on each of the desired tracks. If the Latch Solo Buttons option is deselected, Shift-click to solo multiple tracks.

### Solo Safe Mode

Pro Tools also allows you to *solo safe* a track. This prevents the track from being muted even if you solo other tracks. This feature is useful for tracks such as Auxiliary Inputs that are being used as effects returns, allowing the effects track to remain in a mix even when other tracks are soloed. It is also useful to solo-safe MIDI tracks so that their playback is not affected when you solo audio tracks. To toggle Solo Safe mode, Command-click (Macintosh) or Control-Click (Windows) the Solo button on the track.

### Mute Button

The Mute button silences a track. More than one track can be muted at one time. On TDM systems, if the Mute Frees Voice option is selected, muting a track will allocate its voice to the next highest priority virtual track allocated to that voice in your session.

### Automation Mode Selector

The Automation Mode selector allows you to choose a track's automation mode. Once a track is automation write-enabled, starting playback will start writing automation (depending on the mode you have chosen). Any automation moves that you make on the track can then be played back exactly as you performed them.

## Voice Selector

(TDM Systems Only)

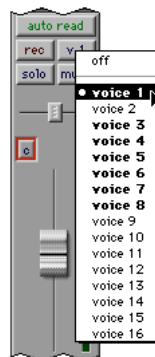

Audio Track Voice Selector

On TDM systems, the Voice Selector is used to assign a *voice* to an audio track for playback. Boldface type in this pop-up menu indicates that the voice is currently in use by one or more tracks.

More than one track can be assigned to the same voice, but only one of the tracks can be played back at the same time. Track priority is determined by a track's position in the Mix or Edit window. If multiple tracks are assigned to the same voice, the one farthest to the left in the Mix window (or top-most in the Edit window) will be heard.

If there is an empty spot in a track that shares a voice with another track, audio on the track with the next-highest priority assigned to the same voice will “pop through” during that time. You can also disable playback of any muted track and free its spot for the next virtual track assigned to that voice by selecting the Mute Frees Voice option. For more information on voices and track priority, see “Assigning Voices and Track Priority” on page 56.

## Input/Output View

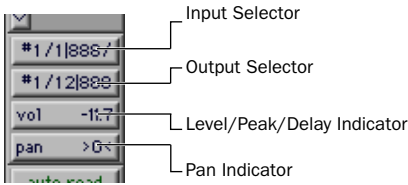

*Inputs/Outputs view in channel strip*

The I/O (Inputs/Output) view shows Input and Output Selectors on Audio tracks, and the Channel Selector on MIDI tracks. Both types of tracks show volume and pan values in this view. To show the I/O View, select Display > Mix Window Shows (or Edit Window Shows) > I/O View.

## Input Selector

(Audio and Auxiliary Input Tracks)

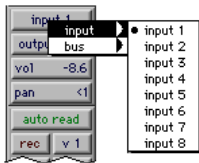

*Audio Track Input Selector*

The Input Selector allows you to route any audio input or any of the Pro Tools internal busses to an Audio track or an Auxiliary Input track.

## Output Selector

(Audio Tracks, Aux Inputs, Master Faders)

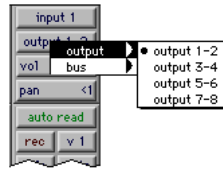

*Audio Track Output Selector*

The Output Selector allows you to route a track to any audio output or any of the Pro Tools internal busses. In Stereo Mix Outputs mode, the pop-up menu allows you to route the track to a pair of outputs or busses. In Direct Outputs mode, the pop-up menu allows you to route the track to a single output.

In Stereo Mix Outputs mode, to send output to the odd-numbered channel, pan left; to send output to the even-numbered channel, pan right.

## MIDI Device/Channel Selector

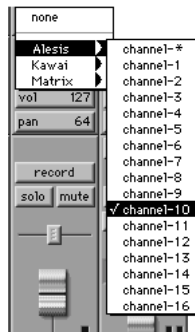

*MIDI Device/Channel Selector*

The MIDI Device/Channel Selector allows you to route the MIDI track to a device and channel.



## Default Program Button

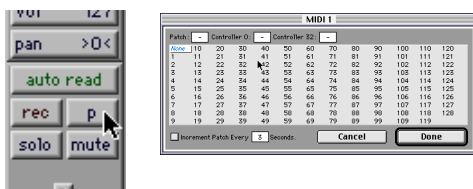

*Default Program button in channel strip*

The Default Program button opens the Program Change window, where you can specify a default program for the track. The track's default program is transmitted each time the track plays.

## Level/Peak/Channel Delay Indicator

The Level Indicator on an Audio track has three modes: Level Indicator, Peak Indicator, and Channel Delay Indicator. Command-click (Macintosh) or Control-Click (Windows) this button to toggle between these modes.

**Level Indicator** Shows the current volume/input level of a track as set by the track level fader.

**Peak Indicator** Functions as a headroom indicator based on the last peak playback level. To reset the peak counter, click the indicator. Values range from +6 dB (highest level signal), to  $\infty$  (no signal).

**Channel Delay Indicator** Shows the delay, in samples, incurred by any TDM Plug-Ins on that channel.

## Pan Indicator

The Pan Indicator displays the current pan setting of a track. Pan values range from <100 (full left) to 100> (full right). Panning controls are only available if you are using Pro Tools in Stereo Mix mode.

## Pan Slider

The Pan slider controls the balance of a track between the assigned output pair. It only appears if you are using Pro Tools in Stereo Mix Outputs mode. The outputs used as the stereo pair for the track's image are set with the Output Selector. The Pan slider on a MIDI track is only effective if you are controlling a sound module that supports MIDI panning.

## Track Level Fader

The track level fader controls the volume of a track when it is in playback, and the monitor level of the track when it is in record.

The level fader on a MIDI track is only effective if you are controlling a sound module that supports MIDI volume.

## Track Level Meter

On Audio tracks, level meters indicate the level of the signal being recorded or played back from the hard drive. Green indicates nominal levels; Yellow indicates pre-clipping (-6 dB below full scale); and Red indicates clipping. When a track is record-enabled, these meters indicate record levels.

You can globally set level meters to indicate pre-or post-fader levels by choosing Operations > Pre-Fader Metering. When set to pre-fader, the level meters show levels independent of fader position. With post-fader metering, the level meters respond to fader position.

If clipping occurs, the topmost LED will stay lit (red). In addition, Pro Tools meters provide a peak hold feature with three options:

To choose a peak hold setting, choose Setups > Preferences and click Display, and select one of the Peak Hold options: 3 Second Peak Hold, Infinite Peak Hold, or No Peak Hold.

You can clear a meter's clipping or peak hold indicator by clicking anywhere on the meter. To clear all meters, Option-click (Macintosh) or Alt-Click (Windows) on any meter.

On MIDI tracks, the level meter shows the MIDI velocity of the most recent MIDI event.

## Track Name

When new tracks are created with the New Track command, they are given a default name which can be changed at any time by double-clicking the track name or choosing File > Rename Selected Tracks.

## Insert Controls

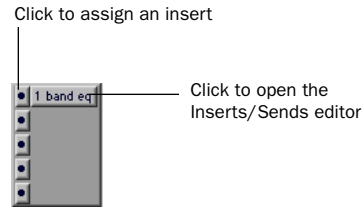

*Inserts view in channel strip*

Pro Tools provides up to five pre-fader inserts per Audio track or Auxiliary Input. The inserts can be either hardware inserts or software Plug-Ins included with your system. To assign an insert, click the Inserts button on the inserts section of a track.

## Send Controls

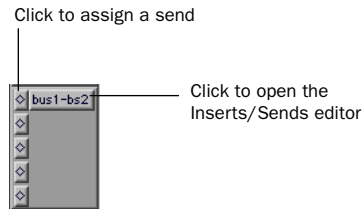

*Sends view in channel strip*

Pro Tools provides up to 5 mono or stereo sends per Audio track or Auxiliary Input, for sending signals to external signal processors or any of the Pro Tools internal buses. Sends can be either pre- or post-fader. To assign a send to a track, click the Sends button on the sends section of the track.

Send level, pan and mute controls can be adjusted from the Inserts and Sends Editor, or directly from the sends area of a track by showing individual send controls.

When you display the controls for an individual Send, you also have the option of displaying Send level meters.

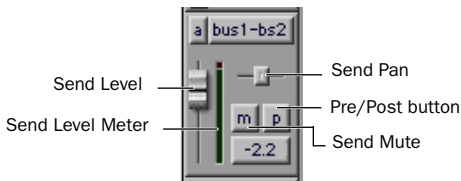

*Sends view showing individual send controls*

## Track Comments View

The Comments View shows any comments entered in the Track Name/Comments dialog. You can also type directly in the Comments area for each track when it is displayed. To display the Comments View, select Display > Mix Window Shows (or Edit Window Shows) > Comments.

---

## The Edit Window

The Edit window provides a time-line display of audio and MIDI for editing and arranging tracks. As in the Mix window, each track has controls for record enable, solo, mute and automation mode.

To display the Pro Tools input/output controls, inserts, sends, and comments, select Display > Edit Window Shows > All.

## Edit Window Track Controls

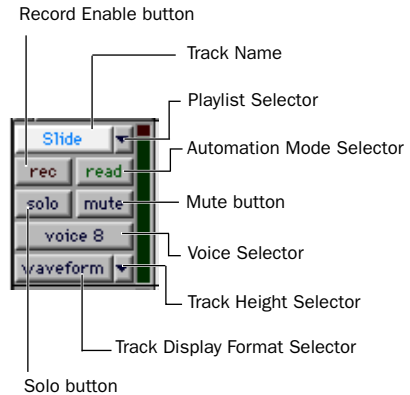

*Edit window track controls (medium track height)*

### Record Enable Button

See “Record Enable Button” on page 18.

### Solo Button

See “Solo Button” on page 18.

### Mute Button

See “Mute Button” on page 19.

### Automation Mode Selector

See “Automation Mode Selector” on page 19.

### Voice Selector

#### (TDM Systems Only)

See “Voice Selector” on page 19.

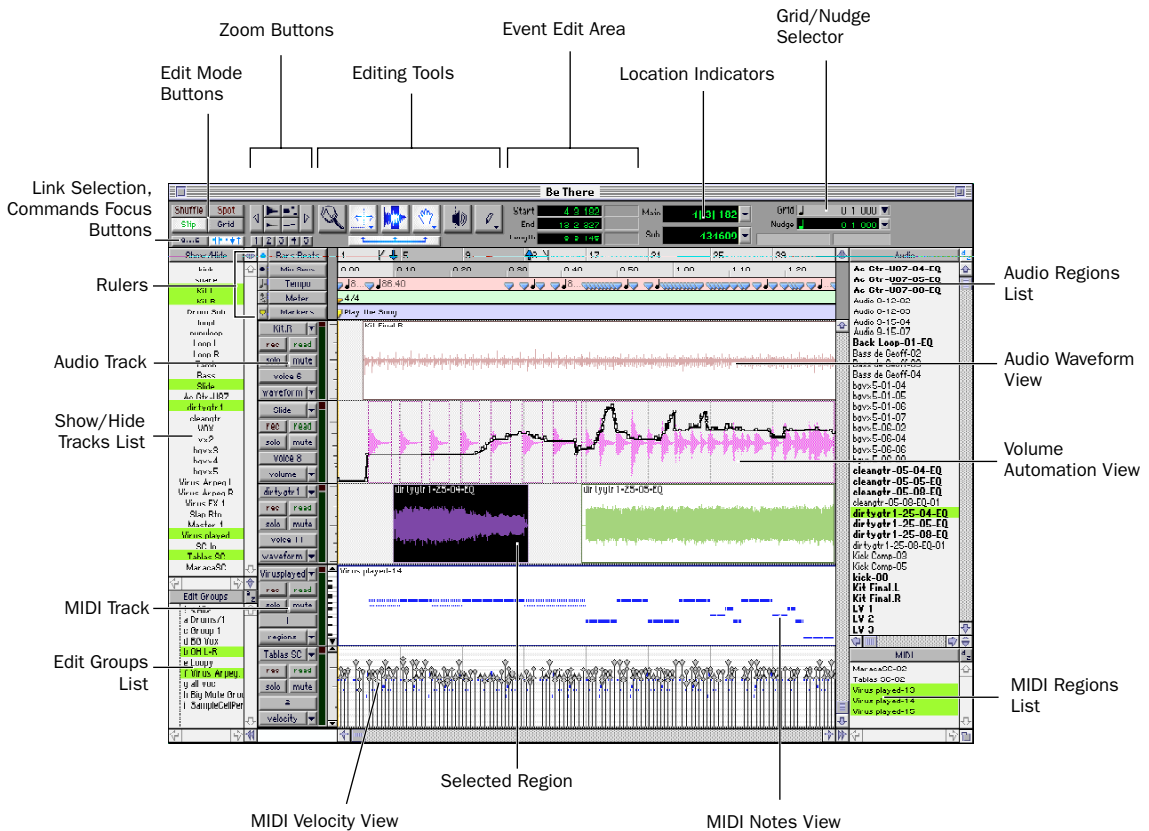

Figure 2. Pro Tools Edit Window

## Playlist Selector



**Playlist Selector**

Tracks have *edit playlists* and *automation playlists*. You can create any number of edit playlists for a track, and assign them by clicking the Playlist Selector in the track and choosing from the pop-up menu. Each track has a single set of automation playlists, according to the type of track and any Send or Plug-In assignments. You choose the automation playlist to display with the Track Display Format Selector.

## Track Height Selector

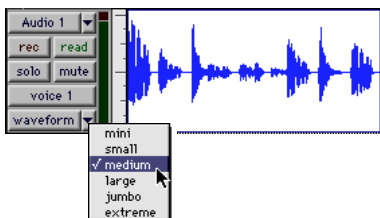

**Track Height Selector**

Tracks can be viewed in the Edit window at any of six heights: *Mini*, *Small*, *Medium*, *Large*, *Jumbo*, and *Extreme*. The appearance of track controls varies with track height. You can adjust track height by clicking either the Track Height Selector or in the area just to the right of the track controls.

## Track Name

See “Track Name” on page 22.

## Track Display Format Selector



**Track Display Format Selector**

The Display Format for each track determines which data is displayed and edited in the track’s playlist area.

Audio tracks can be set to *Blocks*, *Waveform*, *Volume*, *Pan*, *Mute*, *Send Level*, *Send Mute*, *Send Pan*, or any Plug-In parameters that have been automated. Except when editing automation data, audio tracks are usually set to Waveform view.

Auxiliary input tracks can be set to *Volume*, *Pan*, *Mute*, or any Plug-In parameter that has been automated. Master Fader tracks can be set to *Volume*, or any Plug-In parameter that has been automated.

MIDI tracks can be set to *Blocks*, *Regions*, *Notes*, *Volume*, *Pan*, *Mute*, *Velocity*, *Pitch Bend*, *After Touch*, *Program*, *Sys Ex*, and any continuous controller type. Except when editing controller data, program changes, or sysex events, MIDI tracks are usually set to Notes or Regions.

## Edit Modes, Commands Key Focus, and Linked Selections

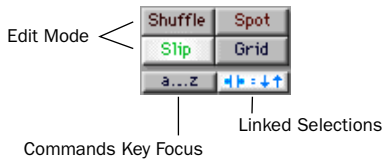

### Edit mode buttons in Edit window

**Shuffle** Sets the Edit mode to Shuffle, which restricts the placement of regions so that they snap to each other and are placed end to end.

\* You can also press F1 to set the Edit mode to Shuffle.

**Spot** Sets the Edit mode to Spot, which causes the Spot dialog to open when moving or trimming regions and notes. The Spot dialog lets you enter a precise start, end, or length (in any time format) for the event.

\* You can also press F2 to set the Edit mode to Spot.

**Slip** Sets the Edit mode to Slip, which allows regions and notes to be moved and trimmed freely. Regions can be placed so that there is space between them, or so that they overlap.

\* You can also press F3 to set the Edit mode to Slip.

**Grid** Sets the Edit mode to Grid, which constrains edits and selections to the current Grid value.

\* You can also press F4 to set the Edit mode to Grid.

**Commands Key Focus** (TDM Systems only) Enables the Commands Key Focus, which provides a wide range of shortcuts from the alpha keyboard for editing and playing.

\* You can also press Command+Option+1 (Macintosh) or Control+Alt+1 to enable the Commands Key Focus.

**Linked Selections** Links the Edit and Timeline selections, allowing you to set play and record ranges by selecting in a track's playlist. When unlinked, you can make Edit selections without disturbing the Timeline selection.

\* You can also press Shift+slash to enable and disable Linked Selections.

## Zoom Buttons

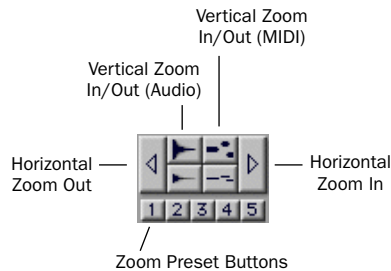

### Zoom buttons in Edit window

**Horizontal Zoom In/Out** Zooms in and out horizontally for all tracks. Option-click (Macintosh) or Alt-click (Windows) either of the Horizontal Zoom buttons to return to the previous zoom level.

---

\* While pressing Command (Macintosh) or Control (Windows), you can also use the bracket keys to zoom in and out horizontally.

---

**Vertical Zoom In/Out (Audio)** Zooms in and out vertically for audio tracks. Option-click (Macintosh) or Alt-click (Windows) either of the Vertical Zoom buttons to return to the previous zoom level.

---

\* While pressing Command+Option (Macintosh) or Control+Alt (Windows), you can also use the bracket keys to zoom in and out vertically for all audio tracks.

---

**Vertical Zoom In/Out (MIDI)** Zooms in and out vertically for MIDI tracks. Option-click (Macintosh) or Alt-click (Windows) either of the Vertical Zoom buttons to return to the previous zoom level.

---

\* While pressing Command+Shift (Macintosh) or Control+Shift (Windows), you can also use the bracket keys to zoom in and out vertically for all MIDI tracks.

---

**Zoom Presets** Recalls horizontal zoom values for audio and MIDI tracks. Command-click (Macintosh) or Control-click (Windows) a Zoom Preset button to store the current horizontal zoom values.

---

\* While pressing Control (Macintosh) or the Start key (Windows), you can also recall a Zoom Preset by typing its number on the alpha keyboard.

---

\* On TDM systems, when the Commands Key Focus is enabled, you can also recall a Zoom Preset by typing its number on the alpha keyboard.

---

## Edit Tools

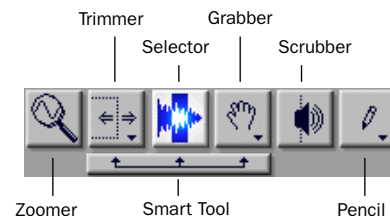

### Edit tools in Edit window

**Zoomer** Click or drag with the Zoomer tool to zoom in horizontally for a track or Ruler. Press Command (Macintosh) or Control (Windows) while dragging to zoom horizontally and vertically.

To go back to the previous zoom level, Option-click (Macintosh) or Alt-click (Windows) with the Zoomer.

To zoom a selection, Option-click (Macintosh) or Alt-click (Windows) the Zoomer tool. To fill the Edit window with all regions, double-click the Zoomer tool.

---

\* You can also press F5 to select the Zoomer tool.

---

**Standard Trimmer** To resize regions or MIDI notes, drag or click near their start/end points with the Trimmer tool. To reverse the direction of the Trim cursor, which determines whether the start or end point is edited, press Option (Macintosh) or Alt (Windows).

The Trimmer can also be used to scale the values for note velocities, controller events, and automation breakpoints.

For TDM systems, choose from the Trimmer pop-up these other Trimmer tools:

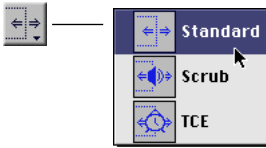

*Trimmer pop-up menu*

- Scrub Trimmer, scrubs audio material to find the trim point before performing the trim.
- TCE Trimmer, expands or compresses audio material to fit within a time range.

---

\* You can also press F6 to select and toggle through the three Trimmer tools: Standard, Scrub, and TCE.

---

**Selector** Drag with the Selector in a track's playlist for an Edit selection, or in a Time-base Ruler for a Timeline selection.

To adjust the length of a selection, Shift-click or Shift-drag with the Selector. To extend an Edit selection to other tracks, Shift-click with the Selector in the desired tracks.

To temporarily switch the Selector to the Scrubber, press Control (Macintosh) or the Start key (Windows).

---

\* You can also press F7 to select the Selector tool.

---

**Time Grabber** Use the Grabber to select or move regions, MIDI events, and Conductor events. The Grabber can also be used to edit and insert automation breakpoints.

Option-click (Macintosh) or Alt-click (Windows) with the Grabber to delete tempo and meter events, Markers, and automation breakpoints.

Choose from the Grabber pop-up these other Grabber tools:

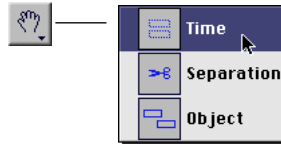

*Grabber pop-up menu*

- Separation Grabber, separates selections into new regions.
- Object Grabber (TDM systems only), allows selection of discontinuous regions, which can even be on different tracks.

---

\* You can also press F8 to select and toggle through the three Grabber tools: Time, Separation, and Object.

---

**Scrubber** Drag with the Scrubber to scrub up to two audio tracks—right for forward, left for reverse. The resolution for the Scrubber is determined by the zoom level, and the distance and speed dragged determine the speed and length for the scrubbed audio.

For finer resolutions without zooming, press Command (Macintosh) or Control (Windows) while scrubbing.

---

\* You can also press F9 to select the Scrubber tool.

---

**Pencil** Use the Pencil tool to insert MIDI notes, edit velocities for a range of MIDI notes, draw automation and controller events, and repair audio waveforms (when zoomed down to the sample level).



Press Option (Macintosh) or Alt (Windows) and the Pencil changes to an Eraser, which can be used to delete notes, program changes, and sysex events.

Choose from the Pencil pop-up any of the five shapes, which can be used to affect a range of note velocities, controller events, or automation breakpoints.

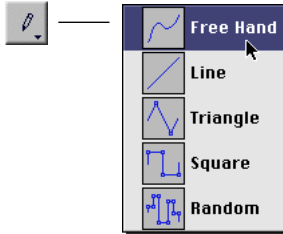

*Pencil pop-up menu*

---

\* You can also press F10 to select and toggle through the five Pencil shapes: Freehand, Line, Triangle, Square, and Random.

---

**Smart Tool** The Smart Tool lets you use the Selector, Grabber, and Trimmer, as well as create fades, without switching tools. Depending on where the cursor is placed in relation to a region or note, the Smart Tool automatically switches to the appropriate tool. For details, see “Using the Smart Tool” on page 29.

To temporarily switch the Smart Tool to the Scrubber, press Control (Macintosh) or the Start key (Windows).

---

\* You can also press F6+F7 (or F7+F8) to select the Smart tool.

---

## Using the Smart Tool

With the Smart Tool you can instantly access the Selector, Grabber, and Trimmer, and you can also perform fades and crossfades. The position of the cursor in relation to a region or note, or within an automation playlist, determines how the Smart Tool functions.

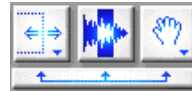

*Smart Tool in Edit window*

To select the Smart Tool, click its icon in the upper left of the Edit window, or press F6+F7 (or F7+F8).

## The Smart Tool in Waveform View

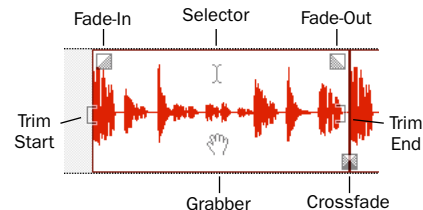

*Smart Tool in Waveform view*

The following capabilities are available with the Smart Tool when working with Audio tracks in Waveform or Blocks view, or MIDI tracks in Regions view:

- ◆ For the Selector, position the cursor over the middle of the region, in the upper half.
- ◆ For the Grabber, position the cursor over the middle of a region, in the lower half.
- ◆ For the Trimmer, position the cursor near the region’s start or end point.

- ◆ For a fade-in or fade-out, position the cursor near an audio region's start or end point, near the top. Drag into the region to set the fade length. The fade is created automatically with the settings last used in the Fades dialog.

- ◆ For a crossfade, position the cursor between two adjacent audio regions, near the bottom. Drag left or right to set the crossfade length. The fade is created automatically with the settings last used in the Fades dialog.

---

\* To temporarily switch the Smart Tool to the Scrubber, press Control (Macintosh) or the Start key (Windows).

---

### The Smart Tool in Notes View

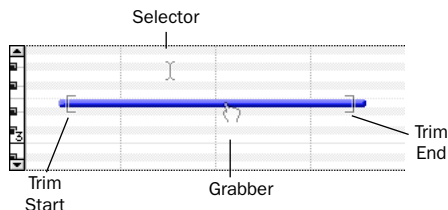

#### Smart tool in Notes view

The following capabilities are available with the Smart Tool when working with MIDI tracks in Notes view:

- ◆ For the Selector, position the cursor so it doesn't cover any notes.

To get the Selector while positioning the cursor over notes, press Command (Macintosh) or Control (Windows).

- ◆ For the Grabber, position the cursor over the note, near its middle.

To get the Marquee so you can select a group of notes, press Command (Macintosh) or Control (Windows).

- ◆ For the Trimmer, position the cursor near the note's start or end point.

---

\* To temporarily switch the Smart Tool to the Pencil, press Control (Macintosh) or the Start key (Windows), for the Eraser, press Control+Option (Macintosh) or Start+Alt (Windows).

---

### The Smart Tool in Automation and Controller Views

The following capabilities are available with the Smart Tool when working in automation and controller views:

- ◆ For the Selector, move the cursor so it is positioned anywhere in the bottom 75% of the playlist.

- ◆ For the Grabber, press Command (Macintosh) or Control (Windows) to insert or edit breakpoints. Continue pressing Command (Macintosh) or Control (Windows) *after* you begin editing for fine control, otherwise release for coarse control.

Press Command+Shift (Macintosh) or Control+Shift (Windows) to vertically constrain movement.

- ◆ For the Trimmer, position the cursor in the top 25% of the playlist to trim breakpoints. Press Command (Macintosh) or Control (Windows) *after* you begin trimming for fine control.

## Event Edit Area

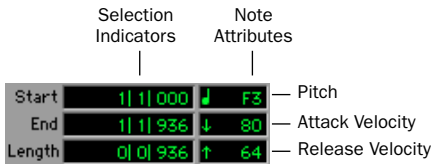

*Event Edit Area showing MIDI track information*

**Start** Displays the start point for a selected region or note, or for an Edit selection. To move the start point, enter a new value in this field.

**End** Displays the end point for a selected region or note, or for an Edit selection. To move the end point, enter a new value in this field.

**Length** Displays the length for a selected region or note, or for an Edit selection. To change the length of the region, note, or Edit selection, enter a new value in this field.

**Pitch** Displays the pitch (including octave number) for a selected note. To change the pitch, enter a new value in this field, or select the field and play a note on your MIDI controller.

**Attack** Displays the attack velocity for a selected note. To change the velocity, enter a new value in this field, or select the field and play a note on your MIDI controller.

**Release** Displays the release velocity for a selected note. To change the velocity, enter a new value in this field, or select the field and play a note on your MIDI controller.

---

\* Press slash (/) to automatically select the Start field, and to navigate from one field to the next. Press Enter to accept a value.

---

## Location Indicators, Grid/Nudge Values, Current Cursor Display

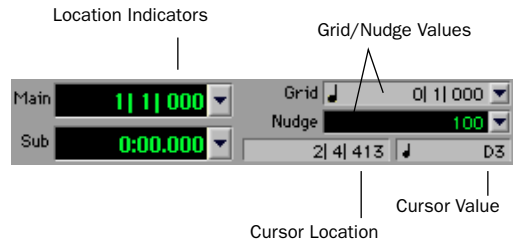

*Edit window display showing MIDI track information*

**Location Indicators** Displays the current play position in the Main and Sub Time Scales. To move the Timeline insertion point to a different location, click in either field, type in the new location and press Enter.

To change the time format for the Main or Sub Time Scale, choose from the pop-up menu to the right of the fields.

---

\* To highlight the Main Location Indicator, press Equal (=) on the numeric keypad. Press period (.) to navigate the different time fields in an indicator, press Enter to go to the new location.

---

**Grid Value** Defines the Grid boundaries used in Grid mode, and when quantizing regions. The Grid value, selected from the pop-up menu to the right of this field, can be based on the Main Time Scale or any of the other time formats.

**Nudge Value** Defines the time value, which can be based on the Main Time Scale or any other time format, used when nudging. Se-

lect the Nudge value from the pop-up menu to the right of this field, or type in any value you want.

In addition to nudging regions and notes, you can also nudge start/end points for regions and notes, start/end points for selections, and region contents.

**Cursor Location** Provides feedback on the current cursor location. This location is displayed in the time format for the Main Time Scale.

**Cursor Value** Provides feedback on the current cursor value. The type of value displayed depends on the Track's Display Format: for instance, note number for Notes view, velocity value for Velocity view, and dB value for Volume view.

## The Edit Groups List

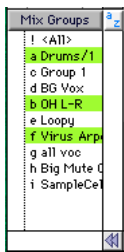

### Edit Groups List

The Edit Groups list shows all groups in the session. It allows you to activate or deactivate a group by selecting or deselecting its name in the list. A group is only *enabled* (meaning that its members are linked for editing purposes), when its name is highlighted in this list.

You can also use this list to select grouped tracks on-screen by clicking to the left of the dotted vertical line next to a group name. The pop-up menu at the top of this list provides commands to create, delete or suspend groups. You can link groups in the Edit Groups and Mix Groups lists. For more information on grouping, see “Grouping Tracks” on page 62.

## Audio Regions List and Pop-up Menu

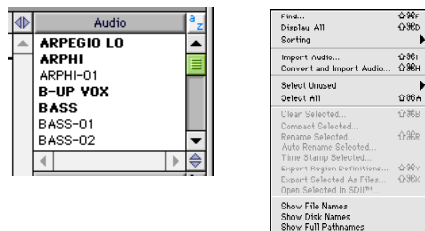

All audio regions that are recorded, imported, or created by editing appear in the Audio Regions List. Regions can be dragged from the list to tracks and arranged in any order.

Using the Audio Regions List pop-up menu (at the top of this list) you can sort this list by a variety of attributes. You can also select, rename and clear regions from the session, as well as import and export audio from this menu.

## MIDI Regions List and Pop-up Menu

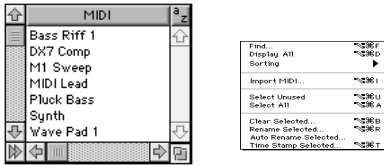

All MIDI regions that are recorded, imported, or created by editing appear in the MIDI Regions List. Regions can be dragged from the list to tracks and arranged in any order.

Using the MIDI Regions List pop-up menu (at the top of this list), you can sort this list by a variety of attributes. You can also rename and clear regions from the session, as well as import MIDI from this menu.

## The Transport Window

The Transport window can be set to show basic transport controls, counters, and MIDI controls. The counters in the Transport window mirror the Location Indicators at the top of the Edit window.

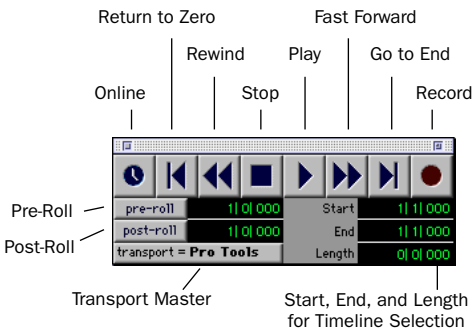

*Transport window showing basic transport controls*

**Online** Puts Pro Tools online so that playback and recording is triggered by an external SMPTE source.

**Return to Zero** Locates to the beginning of the session.

\* You can also press Return (Macintosh) or Enter on the alpha keyboard (Windows) to locate to the beginning of the session.

**Rewind** Rewinds from the current play location. You can also click repeatedly to rewind incrementally (by an amount based on the Main Time Scale).

\* With the Numeric Keypad Mode set to Transport, you can also rewind by pressing 1.

**Stop** Stops playback or recording.

You can also stop the Transport with the following shortcuts:

- Press the Spacebar.
- With the Numeric Keypad Mode set to Transport, press 0.

**Play** Starts playback or (if the Record button was clicked first) recording from the Timeline insertion point.

With the Transport stopped, Control-click (Macintosh) or Right-click (Windows) Play to toggle Loop Playback mode. When enabled, a loop symbol appears in the Play button.

You can also initiate playback with the following shortcuts:

- Press the Spacebar.
- With the Numeric Keypad Mode set to Transport, press 0.

---

\* To play or record at half-speed, Command-click (Macintosh) or Control-click (Windows) the Play button.

---

**Fast Forward** Fast forwards from the Timeline insertion point. You can also click repeatedly to fast forward incrementally (by an amount based on the Main Time Scale).

---

\* With the Numeric Keypad Mode set to Transport, you can also fast forward by pressing 2.

---

**Go to End** Locates to the end of the session.

---

\* You can also press Option+Return (Macintosh) or Control+Enter on the alpha keyboard (Windows) to locate to the end of the session.

---

**Record** Arms Pro Tools for recording (the button flashes). Clicking Play then initiates recording.

With the Transport stopped, Control-click (Macintosh) or Right-click (Windows) Record to cycle through the four record modes. The Record button changes to indicate the currently selected mode: blank for Nondestructive, “D” for Destructive, a loop symbol for Loop Record, and “Q” for QuickPunch.

You can also begin recording with the following shortcuts:

- Press F12.
- Press Command+Spacebar (Macintosh) or Control+Spacebar (Windows).
- With the Numeric Keypad Mode set to Transport, press 3.

**Pre-Roll** Specifies the amount that plays before the beginning of a play or record range. Pre-roll is particularly useful in punch recording since it provides you with time to “catch the beat” before reaching the punch-in point. To set the pre-roll amount, enter a new value in this field, or drag the Pre-Roll flag in the Main Timebase Ruler.

To enable pre-roll, click the Pre-Roll button to the left of the pre-roll field so it becomes highlighted.

**Post-Roll** Specifies the amount that plays after the end of a play or record range. Post-roll is useful in punch recording since playback continues after the punch-out point so you can check for a smooth transition to previously recorded material. To set the post-roll amount, enter a new value in this field, or drag the Post-Roll flag in the Main Timebase Ruler.

To enable post-roll, click the Post-Roll button to the left of the post-roll field so it becomes highlighted.

**Start** Specifies the beginning of the play or record range. You can set the start point by entering a location in this field, by dragging the corresponding Playback Marker in the Main Timebase Ruler, or by selecting

**End** Specifies the end of the play or record range. You can set the end point by entering a location in this field, or by dragging the corresponding Playback Marker in the Main Timebase Ruler.

**Length** Specifies the length for the play or record range. You can set the length by entering a location in this field, or by selecting a range in any Timebase Ruler.

**Transport Master** Specifies the “master” for transport functions. Click this button and choose from the pop-up menu to select the Transport Master, which can be set to Pro Tools, Machine, ADAT, or MMC.

## MIDI Controls

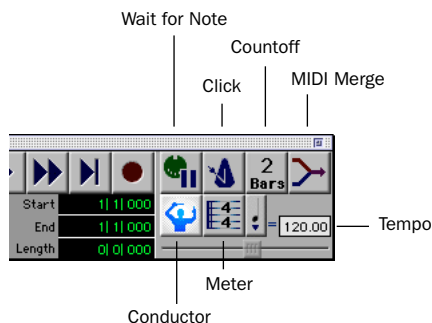

*Transport window showing MIDI controls*

**Wait for Note** When selected, recording does not begin until a MIDI event is received. This ensures that you begin recording when you’re ready to play, and that the first note, or other MIDI data, is recorded precisely at the beginning of the record range.

---

\* You can also press F11 to turn on Wait for Note, unless the Operation Preference for “Disable F11 for Wait for Note” is selected.

---

**Click** When selected, a metronome sounds during playback and recording (as specified by the settings in the Click/Countoff Options dialog).

Double-click the Click button to open the Click/Count Options dialog.

---

\* With the Numeric Keypad Mode set to Transport, you can also press 7 to enable the Click.

---

**Countoff** When selected, Pro Tools counts off a specified number of measures (indicated in the button) before playback or recording begins.

Double-click the Countoff button, to open the Click/Countoff Options dialog.

---

\* With the Numeric Keypad Mode set to Transport, you can also press 8 to enable the Countoff.

---

**MIDI Merge** When selected (Merge mode), recorded MIDI data is merged with existing track material. When deselected (Replace mode), recorded MIDI data replaces existing track material.

---

\* You can also press Option+A (Macintosh) or Alt+A (Windows) to enable MIDI Merge, or with the Numeric Keypad Mode set to Transport, press 9.

---

**Conductor** When selected, Pro Tools uses the tempo map defined in the Tempo Ruler. When deselected, Pro Tools switches to Manual Tempo mode and ignores the Tempo Track.

In Manual Tempo mode, you can enter a BPM value in the tempo field, or tap in the tempo by clicking the Tap button.

**Meter** Displays the session’s current meter based on the play location. Double-click the Meter button to open the Change Meter window.

**Tempo** Display’s the session’s current tempo based on the play location. In Manual Tempo mode, you can enter a BPM value into this field. In addition, when the tempo field is selected, you can tap in a tempo from a MIDI controller.

---

## Keyboard Focus

The Keyboard Focus in Pro Tools determines how the alpha keys function. Depending on which Keyboard Focus is enabled, you can use the keys on your alpha keyboard to select regions in the Audio or MIDI Regions List, enable or disable groups, or perform an edit or play command (TDM systems only).

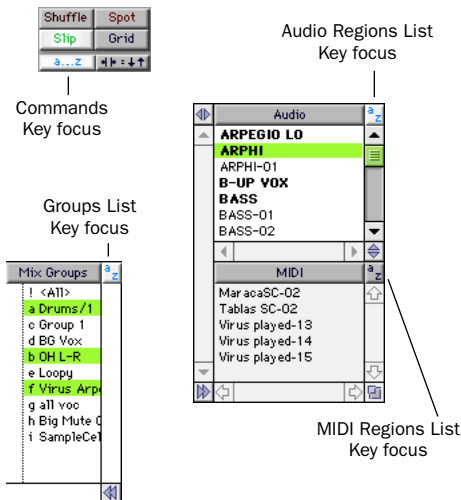

**Keyboard Focus buttons**

### To set the Keyboard Focus:

- Click the a-z button for the focus you want to enable.
  - or –

While pressing Command+Option (Macintosh) or Control+Alt (Windows), press 1 (Commands), 2 (Audio Regions List), 3 (MIDI Regions List), or 4 (Groups List).

You can only enable one Keyboard Focus at a time. Enabling a Keyboard Focus will disable the one previously selected.

**Commands Key Focus** (TDM Systems only) When selected, provides a wide range of shortcuts from the alpha keyboard for editing and playing.

With the Commands Key focus disabled, you can still access any of its key shortcuts by pressing Control (Macintosh) or the Start key (Windows) along with the key.

**Audio Regions List Key Focus** When selected, audio regions can be located and selected in the Audio Regions List by typing the first few letters of the region's name.

**MIDI Regions List Key Focus** When selected, MIDI regions can be located and selected in the MIDI Regions List by typing the first few letters of the region's name.

**Groups List Key Focus** When selected, Edit and Mix Groups can be enabled or disabled by typing the Group ID letter.

---

☞ Refer to the Quick Reference Card that came with your Pro Tools package (TDM systems only) for a complete list of keyboard shortcuts. This card is also available in PDF format in the Release Notes and Documentation folder.

---



# **Part II**

## **Pro Tools Sessions**



## chapter 5

# Creating Sessions

This chapter covers some of the basics of starting a project in Pro Tools, including how to set up and save a Pro Tools session.

---

## Starting Up Your System

In order for the components of your Pro Tools system to communicate properly with each other, you need to start them up in a specific order.

### Start your Pro Tools System in this order:

- 1 Turn on your external hard drives. Wait approximately ten seconds for them to come up to speed.
- 2 If you plan to work with MIDI equipment, turn on your MIDI interface and other MIDI devices.
- 3 Turn on your Pro Tools Audio Interfaces. Wait at least ten seconds for them to initialize.
- 4 Turn on your computer.

### Shut down your Pro Tools System in this order:

- 1 Turn off your Audio Interfaces.
- 2 Turn off your computer.
- 3 If you're using MIDI equipment, turn off your MIDI interface and controllers.

- 4 Turn off your external hard drives.

---

▲ If you launch Pro Tools without turning on your Audio Interface, it will prompt you to turn it on. Allow about ten seconds for your Audio Interface to complete its power-up cycle before clicking OK.

---

---

## Configuring Your System

When you first use Pro Tools, or when you change the input/output scheme for your system, you need to choose Pro Tools Hardware settings.

## Pro Tools TDM Systems

### To change the Hardware Setup:

- 1 Choose **Setups > Hardware**.
- 2 From the **Card** pop-up, select the **Digidesign** card type.
- 3 From the **Interface port** pop-up, choose the port to which your Audio Interface is connected (port A or port B).

Choose port A if only one Audio Interface is connected to the card. If two Audio Interfaces are connected to your card, follow the steps below for each port/interface.

---

\* The Interface port pop-up does not appear for Pro Tools III systems.

---

- 4** From the Sample Rate pop-up, select a sample rate.
- 5** From the Sync Mode pop-up, select the appropriate sync mode on the currently selected interface (Internal or Digital). In most cases you will use Internal. Digital is used primarily for inputting data from DAT or other digital sources.
- 6** From the Ch 1–2 Input pop-up, select the input format of Channels 1–2 of the currently selected interface.
- 7** Click Other Options for additional configuration options specific to the Audio Interface. These include:
  - ◆ Setting the input format (analog or digital) of each pair of input channels on a 888/24 I/O
  - ◆ Configuring the level sensitivity and peak hold settings for the output level meters on the front panel of the 888/24 I/O
  - ◆ Enabling DAC Muting (mutes the 888/24 I/O digital-to-analog convertors when its output level falls below a certain threshold, to reduce noise)
  - ◆ Setting the input and output levels on an 882/20 I/O or a 1622 I/O
  - ◆ Selecting S/PDIF compatibility with Tascam DA30 DAT recorders
- 8** Configure the Other Options parameters and click Done.
- 9** Click OK to close the Hardware Setup dialog.

## Pro Tools LE Systems

### To change the Hardware Setup:

- 1** Choose Setups > Hardware.
- 2** From the Sample Rate pop-up, select a sample rate.
- 3** From the Sync Mode pop-up, select the appropriate sync mode on the currently selected interface. In most cases you will use Internal. S/PDIF (RCA) is used primarily for inputting material from a DAT or other digital sources. Optical (on Digi 001 systems only) is used primarily for inputting material from an ADAT.
- 4** Select a Hardware Buffer Size.
- 5** Click Other Options for additional configuration options specific to your system. These include:
  - ◆ Setting the input gain for a Digi 001 or Audiomedia III
  - ◆ Boosting the output gain for an Audiomedia III
  - ◆ Enabling the Mic/Line High-Pass Filter for a Digi 001
  - ◆ Selecting S/PDIF compatibility with Tascam DA30 DAT recorders
- 6** Configure the Other Options parameters and click Done.
- 7** Click OK to close the Hardware Setup dialog.

---

## Changing the Pro Tools Playback Engine

Pro Tools allows you to select different Playback Engines depending on your system configuration. The Playback Engine determines which Pro Tools card is used for Pro Tools recording and playback features. Supported Digidesign cards include the Pro Tools MIX card, d24 card, Disk I/O card, Digi 001, or Audiomedia III card.

On TDM systems, the Playback Engine is also used to change the Audio Interface assignments for each card.

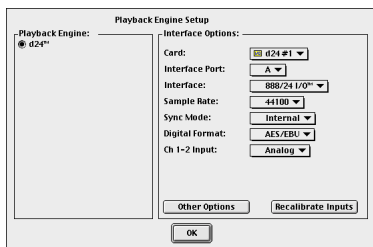

*Playback Engine dialog for Pro Tools 24 system*

### To change an Audio Interface assignment:

- 1 Choose **Setups > Playback Engine**.
- 2 Select from the available Playback Engines.
- 3 Choose the card you want to configure from the Card pop-up menu.
- 4 If available, choose the port to which your Audio Interface is connected from the Interface port pop-up.
- 5 Choose the Audio Interface connected to the currently displayed card or port.
- 6 Set the Sample Rate, Sync Mode, and Channel 1–2 format for the Audio Interface.

7 Click **Other Options** to configure additional options for the Audio Interface.

A Pro Tools session created on one Pro Tools system configuration can be opened and used on a different Pro Tools system configuration. When you change the Playback Engine while a session is open, the session will be saved, closed and reopened to enable your new Playback Engine choice.

If you change your Playback from a TDM-based engine (MIX 64 Voice, MIX 32 Voice, d24, or Disk I/O) to a Pro Tools LE -based engine (Digi 001 or Audiomedia III) you will lose any tracks, busses, or I/O Assignments that exceed the limits of the Pro Tools LE system. Any TDM Plug-Ins that do not have Real-Time AudioSuite (RTAS) equivalents will also be lost.

---

## Changing DAE Playback Buffer Size

The DAE Playback Buffer size determines the amount of memory allocated within DAE to manage disk buffers, which affects system performance.

Though DAE automatically selects the optimal Playback Buffer for your system, you may want to adjust this parameter to modify your system's performance:

- ◆ Allocating a larger buffer can sometimes allow for a higher density of edits. This can be useful if you experience system performance problems in sessions with a large number of edits in rapid succession.

◆ Allocating a smaller buffer can sometimes improve playback/recording initiation speed. This can be useful if you are experiencing a time lag when you initiate playback/recording.

You should also note the following:

- ◆ Choosing a smaller buffer can make it difficult for slower hard disks to play or record tracks reliably.
- ◆ Choosing larger buffer can cause a time lag to occur before playback or recording begins. It can also cause a time lag to occur when you are editing during playback.

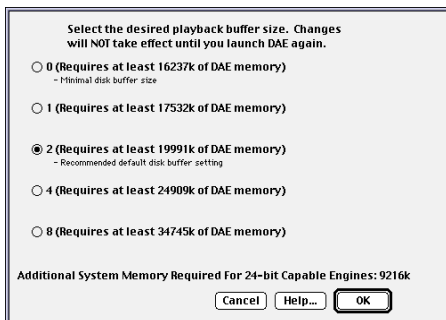

*DAE Playback Buffer Size dialog*

## Macintosh

### To change DAE's Playback Buffer size:

- 1 If you are running Pro Tools, quit Pro Tools.
- 2 Locate and open DAE by double-clicking it. (It is inside the DAE folder within your System Folder.)
- 3 From the DAE File menu, choose Set Playback Buffer Size.
- 4 Adjust the buffer size and Click OK.
- 5 Quit DAE. The next time you open Pro Tools, it will use the playback buffer size you have selected.

## Windows NT

In Windows NT, you can change the DAE Buffer size from the Pro Tools application.

### To change the DAE Buffer Size:

- Choose Setups > DAE Buffer Size and adjust the Buffer Size. Restart your computer for this change to take effect.

---

## Creating a New Session

The first step in beginning a Pro Tools project is creating a new session. When you do this, Pro Tools automatically creates a new folder named after your session. Within this folder is the session file and two other folders, an Audio Files folder, and a Fade Files folder.

The Audio Files folder contains all audio recorded during the session. The Fade Files folder contains any crossfaded audio data generated by the session.



*Typical session folder*

When you record a new audio track, the track is saved as a new audio file and automatically placed in the Audio Files folder. You can also import other audio files into the session, and work with them as well.

## To create a new session:

- 1 Choose File > New Session.

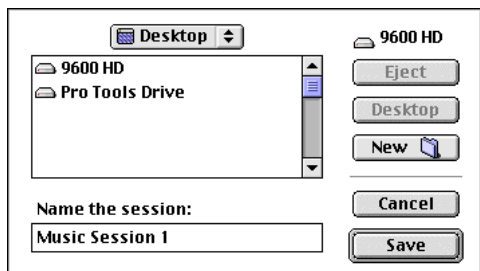

*New Session dialog*

2 Choose the drive where you want to save the session. On Pro Tools III systems, sessions can only be created on drives that are connected to your Pro Tools Disk I/O SCSI chain. All other systems allow you to create your sessions on any SCSI drive attached your computer.

3 On Pro Tools 24 MIX and Pro Tools 24 systems, choose the file type (on Windows computers) and bit depth of your session by doing one of the following:

- ◆ On Macintosh, select the bit depth (24-bit or 16-bit) and click OK.
- ◆ In Windows, choose a file type from the Save as Type pop-up menu.

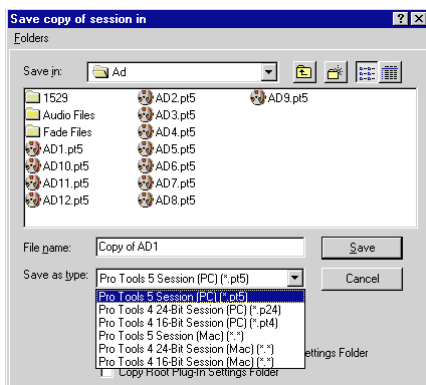

*Selecting a File Type in Windows*

## Pro Tools 5 Session (PC) (.pt5)

Stores session file in Pro Tools 5.0 format, and stores audio as WAV files, which are readable by Pro Tools 24 and Pro Tools 24 MIX systems on the Windows platform. You set the bit depth for Pro Tools 5.0 sessions by selecting 16-bit or 24-bit in the area under the Save as Type pop-up menu.

## Pro Tools 4 24-bit Session (PC) (.pt24)

Stores session file in Pro Tools 4 format, and stores audio as 24-bit WAV files, which are readable by Pro Tools 24 and Pro Tools 24 MIX systems on the Windows platform.

## Pro Tools 4 16-bit Session (PC) (.pt4)

Stores session file in Pro Tools 4 format, and stores audio as 16-bit WAV files, which are readable by Pro Tools 24 and Pro Tools 24 MIX systems on the Windows platform.

## Pro Tools 5 Session (Mac) (\*.\*)

Stores session file in Pro Tools 5.0 format, and stores audio as SoundDesigner II files, which are readable by Pro Tools 24 and Pro Tools 24 MIX systems on both Macintosh and Window platforms. You set the bit depth for Pro Tools 5.0 sessions by selecting 16-bit or 24-bit in the area under the Save as Type pop-up menu.

## Pro Tools 4 24-bit session (Mac) (\*.\*)

Stores session file in Pro Tools 4 format, and stores audio as 24-bit SoundDesigner II files, which are readable by Pro Tools 24 and Pro Tools 24 MIX systems on both Macintosh and Window platforms.

## Pro Tools 4 16-bit session (Mac) (\*.\*)

Stores session file in Pro Tools 4 format, and stores audio as 16-bit SoundDesigner II files, which are readable by Pro Tools III,

Pro Tools 24 and Pro Tools 24 MIX systems on both Macintosh and Windows platforms.

4 Enter a name for the session and click OK (Macintosh) or Save (Windows).

## Choosing a Bit Depth

(Pro Tools 24 MIX and Pro Tools 24 only)

When choosing a bit depth for your session, consider the disk space and DSP mixing power your selection will require. 24-bit sessions occupy about 50% more disk space and power fewer mixer channels per DSP chip. It is not possible to combine different bit depths within a single session.

## Adding Tracks

To create new tracks:

- 1 Choose File > New Track.
- 2 In the New Track dialog, choose the type of track to create from the pop-up menu.
- 3 Enter the number of new tracks you want to create, and click Create. Pro Tools automatically names new tracks.



Creating a new track

\* To auto-scroll the Track Type pop-up in the New Track dialog, press Command (Macintosh) or Control (Windows) and use the Up/Down Arrow keys.

To rename a track:

- 1 In the Edit or Mix window, double-click the Track Name.
- 2 In the Track Name/Comments dialog, type a new track name.
- 3 Type comments for the track in the Comments text box. Click Previous or Next to rename another track.

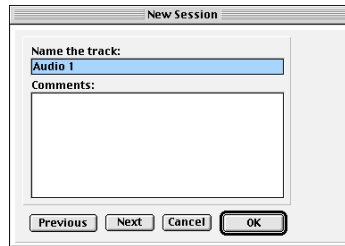

Track Name/Comments dialog

\* To switch tracks in the Track Name/Comments dialog, you can also press Command (Macintosh) or Control (Windows) and use the Up/Down Arrows.

- 4 When you are finished, click OK.

## Displaying track controls

To conserve space on-screen, Pro Tools allows you to show or hide the controls for input/outputs, inserts, sends, and comments on your tracks, in either the Mix or Edit window.

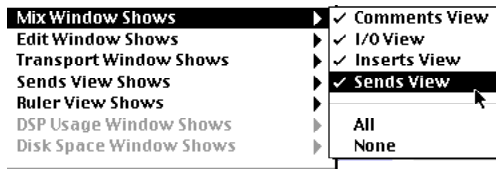

Displaying Inserts or Sends



### To display track controls:

■ Choose Display > Mix Window Shows, or Edit Window Shows, and select the controls you want to display from the sub-menu.

**Comments View** This view shows the comments you enter when creating the track, or type directly into the comment area.

**I/O View** Shows the standard input and output controls for tracks.

**Inserts View** Shows the Inserts on a track. Audio, Auxiliary Input and Master Fader tracks can have up to five unity-gain, pre-fader, in-line Inserts. (Master Fader channels are post-fader only.)

**Sends View** Audio and Auxiliary Input tracks can have up to five sends that allow you to send that track's signal to an external signal processor or any internal busses. Sends can be wither mono or stereo and can be either pre- or post-fade. You can choose to show all the send assignments for your tracks, or you can show the level, mute, pre/post and (in the case of stereo sends) pan controls for individual sends.

### To show the controls for individual sends:

■ Choose Display > Sends View Shows and choose the send you wish to display from the submenu. To show all send assignments for your tracks, choose Assignments.

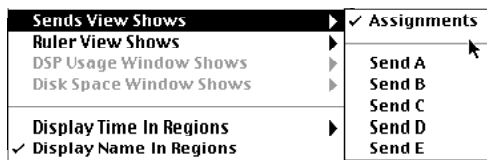

Displaying controls for a send

See *Chapter 19: Basic Mixing* for more information on Inserts and Sends.

## Opening a Session

When you open a session, Pro Tools looks in the same directory for its associated audio and fade files.

### To open an existing session:

1 Choose File > Open Session.

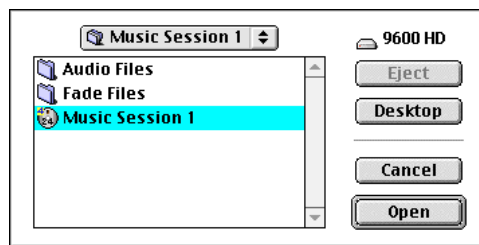

Open Session dialog

2 Locate the session you want to open and click Open.

## Recent Folders and Files

### (Windows NT Only)

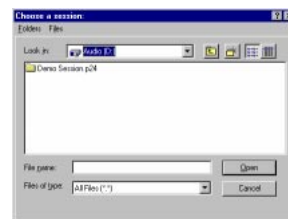

Open Session dialog (Windows)

In Windows, the Open Session Dialog has two menus that allow you to navigate directly to recent directories (by choosing a location from the Folders menu) or directly open recent session files (by choosing a filename from the Files menu).

---

## Saving a Session

Save regularly while working on your session to ensure that your work is preserved on your hard disk.

### Speeding up Saves by Reducing the Disk Cache Size

(Macintosh Only)

To speed up session saves and disk bounces, it is recommended that you reduce the Cache Size (in the Memory Control panel) for your Macintosh to 512k.

## Saving the Session File

The Save Session command saves the changes you have made to your session and writes them over the previously saved version of the file. The Save Session command cannot be undone.

### To save a session:

- Choose File > Save Session.

If you have made changes to a session since you last saved it, you can discard the changes and revert to its previously saved state.

### To revert to the last saved version of a session:

- Choose File > Revert to Saved.

## Saving the Session File with a New Filename

The Pro Tools Save Session As command is useful for saving a copy of the current session under a different name, or in a different hard disk location. Because the Save Session As command closes the current session and lets you keep working on the renamed copy, it is particularly useful if you are experimenting and want to save successive stages of the session.

By working this way, you can quickly retrace your steps should you want to go back to an earlier version of your session. By using the Save Session As command you are saving a new version of the *session file* only—not duplicate versions of the audio or Fade files.

### To save a session under another name:

- 1 Choose File > Save Session As.
- 2 Choose the destination and type a new name for your session. On Pro Tools III systems, sessions and their associated audio files must be saved to a drive connected to the Disk I/O.
- 3 Click Save to save the session.

The renamed session document is saved in the session folder along with the original session. Any new audio files that you record in your renamed session will be placed into the same Audio Files folder that was created for your original session.

To keep audio files for different sessions in separate folders, choose File > New to create a new session.

To copy the track layout, signal routing and Plug-In choices in your session, you can create a Session Template of your original session. For details, see “Creating Custom Session Templates” on page 48.

## **Saving the Session File and its Associated Files**

The Pro Tools Save Session Copy In command is used to save a copy of the currently selected session document under a different name, in a different hard disk location, in a different session file format, or at a different bit-depth (such as saving a 16-bit version of a 24-bit session).

Unlike the Save Session As command, Save Session Copy In does not close the original session, so subsequent edits are made to the original session. The saved session serves as a backup copy, and gives you the option of reverting to the earlier version of the session.

This command also gives you several options for copying a session along with its associated files.

### **Copy Audio Files & Session Plug-In Settings Folder**

When this option is selected, all audio files and the session’s Plug-In Settings Folder are copied to the new location. The references to these Plug-In settings in the session are redirected to point to the copied files.

### **Copy Root Plug-In Settings Folder**

When this option is selected, the contents of the root-level Plug-In Settings Folder are copied into a folder named *Place in Root Set-*

*tings Folder*, indicating that these files will need to be moved to the root level Plug-In settings folder on the destination system before you can use them. The references to these settings files in the session are *not* redirected to point to the copied files.

### **Copy Movie/Video Files**

When this option is selected, a session movie files are copied to the new location, and the references in the session to the movies are redirected to point to the copied movie files.

### **Format**

**Macintosh** Provides the option of saving the current session in 24-bit or 16-bit format, as well as in Pro Tools 4.3 format for Pro Tools 3.2 format for compatibility with older systems. By saving down to Pro Tools 4.3 format, you will lose any MIDI data, marker information, and other data unique to the Pro Tools 5.0 session format.

By saving down to Pro Tools 3.2 format, you will lose any Plug-In automation, as well as mix and edit groups, and other data (such as memory location attributes) unique to the Pro Tools 5.0 or Pro Tools 4.3 session format.

**Windows NT** Provides the option of saving the current session in Pro Tools 5.0 format for Macintosh or Windows, Pro Tools 4 24-bit (.p24) or Pro Tools 4 16-bit format (.pt4) for Windows, and Pro Tools 4 24-bit or Pro Tools 4 16-bit format for Macintosh.

To save a session in a different location or in a different format:

- 1 Choose File > Save Session Copy In.

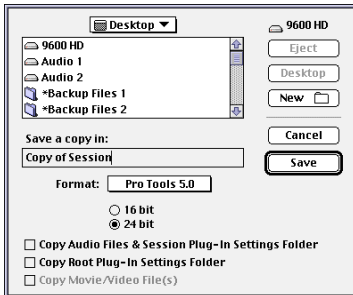

Save Session Copy In dialog (Macintosh)

- 2 Choose a destination and type a name for the new session file.
- 3 Choose the format for the session copy by selecting it from the Format pop-up.
- 4 Select the bit depth for the session copy.
- 5 To copy the session along with all of its associated files, select from the available options.
- 6 Click Save to save the session in the new location.

## Creating Custom Session Templates

You can create custom session documents that are pre-configured to the track setups, mixer setups, window arrangements, and zoom level memory locations that you use most frequently. Doing this will save you the trouble of having to create your studio setup from scratch every time you start a new session.

## Creating Macintosh Templates

You can create a session template on the Macintosh by saving a session file as a *Stationery pad* document. Once a session is saved as stationery, it acts as a template that you can open and then resave as a normal session.

To create a custom session template:

- 1 Create a session and arrange the Mix, Edit, and Transport windows as you like. You can choose which windows are open and where they appear on the screen. You can also define the parameters within these windows, such as signal routings, inserts and sends configurations, track views, ruler settings, and Preference settings.
- 2 Choose File > Save Session.
- 3 Name the session and click Save.
- 4 Close the session.
- 5 Locate the session file that you just saved.
- 6 Click once on the file to select it.
- 7 Choose File > Get Info. A file information window appears.

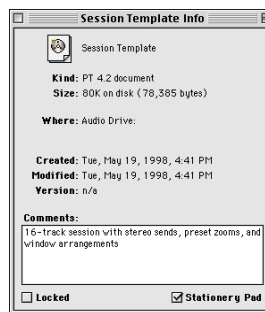

Saving a session as a Stationery pad (Macintosh)

- 8 Click the Stationery Pad check box to save the file as a template, then close the information window.

To use this template, double-click it or open it with the Open Session command if you are already running Pro Tools. You can create several custom templates for studio setups that you frequently use.

When you open a session saved as a Stationery pad, Pro Tools gives you the option of editing the template or starting a new session using the template settings. If you choose New Session, Pro Tools will create a new folder containing a copy of your session template and Audio and Fades folders.

## Creating Windows Templates

In Windows, you can create a session template by making a session file a Read Only document.

### To create a custom session template in Windows:

- 1 Create a session and arrange the Mix, Edit, and Transport windows as you like. You can choose which windows are open and where they appear on the screen. You can also define the parameters within these windows, such as signal routings, inserts and sends configurations, track views, ruler settings, and Preference settings.
- 2 Choose File > Save Session.
- 3 Name the session and click Save.
- 4 Close the session.
- 5 Locate the session file that you just saved.
- 6 Right-click the file and choose Properties.

- 7 Click the General tab and select the Read Only option.

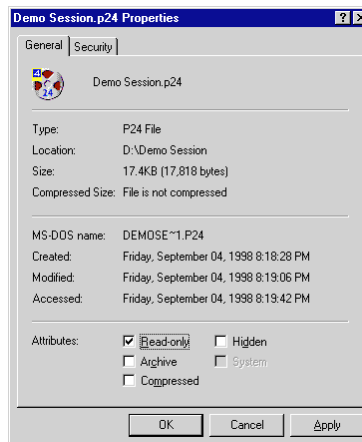

### Making a session a Read Only file (Windows)

- 8 Click OK.

To use this template, double-click it or open it with the Open Session command. When you first save the session, Pro Tools will ask you to give the session a new name. Your original session template will remain unchanged.

To modify the session template, you will need to reopen its Properties and deselect the Read Only option, make your modifications, then change it back to a Read Only file.

---

## Closing a Session

Because Pro Tools allows you to work on just one session at a time, you must close the current session if you want to work on another. The Close Session command closes your current Pro Tools session but leaves the Pro Tools application open. You can save your work using the Save Session or Save Session As command before closing the current session.

### To close a session:

- Choose File > Close Session.

---

## Quitting a Session

Although Pro Tools will warn you before allowing you to quit without saving changes, you should generally save your work before quitting.

### To Quit a Session:

- Choose File > Quit (Macintosh) or File > Exit (Windows).

---

## Sharing Sessions between Pro Tools TDM Systems and Pro Tools LE Systems

Pro Tools makes it easy to share sessions between Pro Tools LE and TDM-equipped systems. There are some important differences between the two types of systems that can affect how session material is transferred.

If you transfer a session from a TDM-equipped Pro Tools system to a Pro Tools LE-based system, any tracks, buses, or I/O Assignments that exceed the limits of the Pro Tools LE system will be lost. Any TDM Plug-Ins that do not have Real-Time AudioSuite (RTAS) equivalents will also be lost.

### Differences between TDM and LE systems

Feature	TDM Systems	LE Systems
Number of Tracks	up to 128	limited to 24
Number of mix busses	32 busses	16 busses
Inserts per Track	up to 5 inserts	up to 5 inserts
Sends per Track	up to 5 sends	up to 5 sends

## chapter 6

# Working with Tracks

This chapter covers basic track management tasks such as creating and deleting tracks, assigning voices and output channels, and grouping tracks.

---

## Creating Tracks

You can add tracks to your session at any time by using the New Track command. New tracks appear in both the Edit and Mix windows.

## Adding New Tracks

You can choose where to insert new tracks by selecting an existing track's name.

### Before you create new tracks:

- ◆ For new tracks to appear next to a specific track in a session, select that track by clicking its name. The new tracks are added immediately after the selected track.
- ◆ For new tracks to appear as the last tracks in a session, make sure that no track names are selected on-screen.

### To create a new audio or MIDI track:

- 1 Choose File > New Track.
- 2 Choose the type of track to create from the pop-up menu.
- 3 Enter the number of new tracks and click Create.

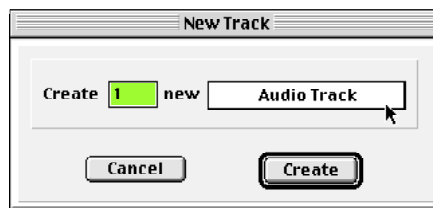

*Creating a new track*

- 4 To name a track, double-click the Track Name button at the bottom of the Mix window. Enter a name and any comments for the track, and click OK.

The track name will be given to any audio files that you record on the track.

5 Choose which controls appear on the track by choosing Display > Mix Window Shows or Display > Edit Window Shows and selecting the controls from the sub-menu.

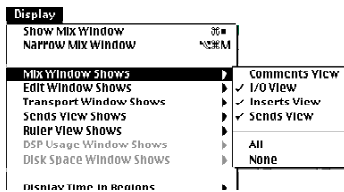

#### Displaying track controls

#### To rename existing tracks in your session:

- 1 Select the track to rename by clicking the track name (Shift-click to select multiple tracks).
- 2 Choose File > Rename Selected Tracks.
- 3 Type a new name and click OK for each track you are renaming.

## Deleting Tracks

When you delete tracks, your audio or MIDI region data will remain in the Regions List, but your arrangement of the regions on the deleted track (the track's playlist) will be lost. The Delete Selected Tracks command cannot be undone.

#### To delete a track:

- 1 Click the name of the desired track to select it. If you wish to select multiple tracks, hold down the Shift key and click additional track names to select them as well.
- 2 Choose File > Delete Selected Tracks.
- 3 Click OK to remove the selected tracks from the session.

## Hiding Tracks

The Show/Hide Tracks List (at the left of both the Mix and Edit windows) shows all tracks in the session. It allows you to show or hide a track by selecting or deselecting its name. Even though a track is hidden, the material on the track will still play as part of the session.

To show a track, click to highlight its name. To hide a track, deselect its name.



#### The Show/Hide Tracks List

The pop-up menu at the top of Show/Hide Tracks List provides commands that allow you to show or hide all tracks, or only tracks currently selected on screen.

When a track that is a member of an active group is hidden from view, editing operations performed on other members of the group in the Edit window will not affect the hidden track. In the Mix window however, all operations other than record-enabled will affect a hidden track that is a member of an active group.

▲ On TDM systems, even if a track is hidden from view, its position relative to other tracks still affects virtual track playback priority.



### To hide a track:

- Click the highlighted name of a track in the Show/Hide Tracks List.

### To show a track that is currently hidden:

- Click the unhighlighted name of a track in the Show/Hide Tracks List.

### To show all tracks:

- 1 Click the Show/Hide button at the top of the Show/Hide Tracks List.
- 2 From the pop-up menu, choose Show All Tracks.

### To hide all tracks:

- 1 Click the Show/Hide button at the top of the Show/Hide Tracks List.
- 2 From the pop-up menu, choose Hide All Tracks.

---

\* To reorder tracks on screen, drag the track names to new positions within the Show/Hide Tracks List.

---

---

## Assigning Track Inputs

Your Pro Tools system has a certain number of hardware inputs, in the form of the physical inputs on your Pro Tools Audio Interface, your Digi 001, or your Audiomedia III card. Pro Tools also provides internal mix busses that can be the source of track inputs.

With Pro Tools 24 MIX, Pro Tools 24 and Pro Tools III systems, if you have multiple Audio Interfaces, their default I/O Labels appear in order as input #1/1-8, input #2/1-8, and so on.

### To assign a track input:

- 1 If I/O controls are not currently visible on your tracks, choose Display > Mix Window Shows (or Edit Windows Shows) > I/O View.
- 2 Click the input selector button on the track, and choose an available input source from the pop-up menu.



*Input selector*

---

## Assigning Track Outputs

Your Pro Tools system has a certain number of hardware outputs, in the form of the physical outputs on your Pro Tools Audio Interface, your Digi 001, or your Audiomedia III card. Pro Tools also provides internal mix busses that can be the destination of track outputs.



*Output selector (Stereo Mix Outputs mode)*

Pro Tools has two different operating modes, Direct Outputs mode and Stereo Mix Outputs mode. These modes allow you to configure Pro Tools to match your particular studio setup.

**Direct Outputs mode** In this mode, each track output is routed to a single Audio Interface output. Track panning controls are not available in Direct Outputs mode. With Pro Tools 24 MIX, Pro Tools 24 and Pro Tools III systems, if you have multiple Audio Interfaces, their default I/O Labels appear in order as output #1/1-8, output #2/1-8, and so on.

**Stereo Mix Outputs mode** In this mode, track outputs are routed to a pair of Audio Interface outputs or bus pairs, such as output #1 1-2, output #1 3-4, and so on. Each track contains controls for panning between the two selected output pairs.

### To assign a track to an output:

- 1 If I/O controls are not currently visible on your tracks, choose Display > Mix Window Shows (or Edit Windows Shows) > I/O View.
- 2 Click the output selector button on the track and choose an available output destination from the pop-up menu.

---

## Virtual Tracks, Voices, and Track Priority

(TDM Systems Only)

### Voices and Virtual Tracks

Pro Tools 24 MIX core system hardware provides up to 64 simultaneous voices of audio playback. Pro Tools 24 core systems provide up to 32 voices of audio playback. A Pro Tools III system provides 16 voices.

While your Pro Tools hardware allows a fixed number of voices, Pro Tools software provides for up to 128 *virtual tracks*—tracks which can be recorded upon and cued up for playback but cannot all be played back simultaneously.

In such an environment where there are potentially more tracks than can play back at one time, Pro Tools assigns priorities for tracks that compete for the available voices. Pro Tools provides two ways of assigning playback priority to audio tracks:

**Voice Selector** When you click a track's voice selector, a pop-up menu appears offering a choice of voice numbers, which refer to voice assignments.

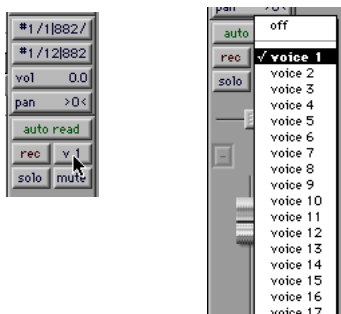

**Audio Track Voice selector**

**On-screen track placement** The left-most track in the Mix window (or the topmost track in the Edit window) has priority over other tracks with the same voice assignment.

It is possible to assign more than one track to the same voice, but only one of the tracks—the one with highest priority—will play.

Choosing Options > Mute Frees Voice and muting a track disables playback of that track, and surrenders control of its voice to the next highest priority track with the same voice assignment.

Pro Tools features *dynamic voice allocation*, so that when a hole opens up in a higher-priority track, its voice is temporarily available, and the track with the next highest priority “pops through” and begins to play. When the original track returns, the track that had popped through relinquishes the voice to the higher priority track.

The following example demonstrates the concept of dynamic voice allocation:

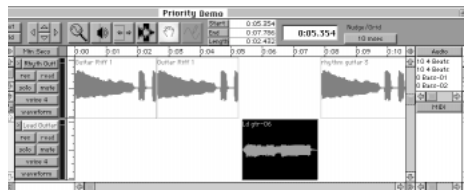

**The “Lead Guitar” region will pop through**

In the above illustration, the two visible tracks are assigned to the same voice. There is an open area in the top track where no region appears. At this point, the voice is free since it is not being used, and the next highest priority track on that voice (the bottom track) will pop through the open area and play. In order for a lower priority region to pop through, it must be placed so that its beginning occurs *after* a higher priority track's region has ended.

## Automatic Assignment of Ascending Voices

### (TDM Systems Only)

You can automatically assign all tracks or all selected tracks to successive voices. For example, you may want to select eight audio tracks and reassign them to voices 9–16.

#### To assign all audio tracks to successive voices:

- While pressing Command+Option (Macintosh) or Control+Alt (Windows), click on the Voice Selector for any track and choose the starting voice number.

The track with the highest priority is assigned to the chosen voice, with all other tracks assigned to successive voices.

**To assign all selected audio tracks to successive voices:**

- 1 Select the desired audio tracks by Shift-clicking their names.
- 2 While pressing Command+Shift (Macintosh) or Control+Shift (Windows), click on the Voice Selector for any of the selected tracks and choose the starting voice number.

Of the tracks that are selected, the one with the highest priority is assigned to the specified voice, with all other selected tracks assigned to successive voices.

---

## Assigning Voices and Track Priority

You can use track priority settings, voice assignment, and output assignments to get the most out your system configuration.

**To assign an audio track to a voice:**

- 1 Click the track's voice selector.

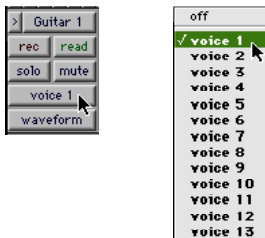

*Assigning a voice*

- 2 Select a voice from the pop-up menu. Voices listed in boldface type are already in use by other tracks in the session.

## Changing a Track's Playback Priority

When more than one track is assigned to the same voice, the track that occurs earliest (left-most in the Mix window or top-most in the Edit window) has priority over others assigned to that voice. Moving another track of the same voice to a higher position will then give that track priority.

You can drag a track to a new position in either the Mix or Edit windows to change its playback priority.

**To increase a track's priority in the Edit window:**

- Click the track's Track Name button and drag it above another track assigned to the same voice.
  - or –
- In the Show/Hide Tracks List, drag the track to a higher position in the list of tracks. Tracks nearer the top of this list have higher priority.

**To increase a track's priority in the Mix window:**

- Click the track's Track Name button and drag it to the left of another track assigned to the same voice.
  - or –
- In the Show/Hide Tracks List, drag the track to a higher position in the list of tracks. Tracks nearer the top of this list have higher priority.

By experimenting with track priority, voice assignment, and arranging regions so that they are positioned to “pop through” holes

in higher priority tracks, you will find many useful ways to apply virtual tracks and dynamic voice allocation.

## Voice Management In Expanded Systems

(Macintosh Pro Tools III systems only)

### Voice Numbering

In expanded Pro Tools III systems, the first 16 voices of your system are numbered A-1 through A-16. The next Disk I/O's voices would be numbered B-1 through B-16, and so on.

### Managing Voices in Expanded Systems

In expanded Pro Tools III systems each Disk I/O card requires that a separate SCSI hard drive be attached to it, with specific audio files residing on specific drives. An audio file or region that resides on one Disk I/O's hard drive cannot be moved to a track routed to a different Disk I/O drive. If you try to do this, Pro Tools will alert you and allow you to automatically copy the sound file to the destination voice's drive.

The following scenarios will cause voice assignment conflicts which you will have to resolve by either reassigning voices, copying sound files, or managing "Ghost regions":

- If you attempt to put regions from Disk I/O "A" voice track onto a Disk I/O "B" voice track.
- If you attempt to drag a region that resides on Disk I/O "A" from the Audio Regions List onto a track which is assigned to a Disk I/O "B" voice track.

- If you have a multiple Disk I/O system and you assign a track to a voice which does not correspond to the hard drive that the track's regions belong to.
- If you have a multiple Disk I/O system and you've moved a drive which was originally connected to a different Disk I/O.

Pro Tools will copy the entire sound file (not just the single region) to the appropriate Audio Files folder on the destination drive.

The audio file will be copied to whatever drive is specified in the Disk Allocation dialog box for that track. Before you begin copying files, be sure the destination drive has sufficient space. If the destination drive doesn't have enough space, the copy procedure will be cancelled and any material that hasn't been fully copied will be discarded.

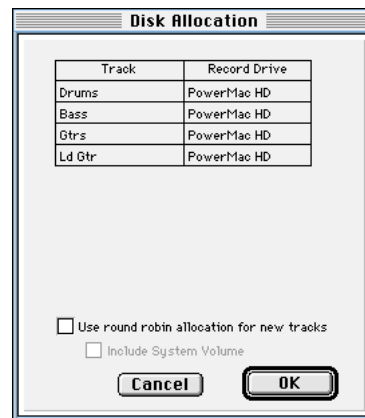

*Disk Allocation dialog*

## Ghost Regions

If you decide not to copy the file, Pro Tools will display what are called *Ghost regions*. Ghost regions occur in cases where Disk I/O SCSI chain/voice combinations make them invalid for playback. A Ghost region appears “grayed out” (much like a muted region does) and signifies that the audio is not present on the drive to which the voice refers, and is not available for audio playback as currently assigned.

If you have Ghost regions in a session, each time you open the session it will ask you if you wish to copy the Ghost regions onto the appropriate drive so that you will be able to use the regions as voiced.

Ghost regions can still be selected with the Grabber tool and moved or deleted, or auditioned from the Regions List. They will not play as currently assigned. They can become regular “active” regions again if you place them on a track/voice that is valid for the Disk I/O associated with the region.

If you open a session which has a region/voice/hard drive assignment conflict, a warning dialog will appear, alerting you of this condition and offering several solutions. The options in the dialog are as follows:

**Look for Duplicated Files** If this option is enabled, before it begins copying files to the necessary drive, Pro Tools will check if the needed “parent” audio files or regions have already been copied to the drive. This helps prevent unnecessary duplication of audio data.

**Look for Compatible Voices** If this option is enabled, Pro Tools will try to resolve the problem by assigning conflicting voices from the “swapped” drive to available valid voices.

**Copy Files to New Drives.** If this option is enabled, Pro Tools will copy the files to the necessary drive (if there is enough space). If the Look for Duplicated Files option is also enabled, Pro Tools will check if the needed “parent” audio files or regions already reside on the drive before it begins copying. If the Look for Duplicated Files option is not enabled, Pro Tools will copy the required files without checking first.

## Alternatives to Copying an Entire Audio File

If you wish to move a region without copying the entire sound file, you can place the region on a track which is routed to a drive where the audio actually resides. Alternatively, you can use the Duplicate Plug-In in the AudioSuite menu, or you can bounce the region to disk, thereby creating a new audio file that consists of just the region. Refer to the *DigiRack Plug-Ins Guide* to learn how to use the Duplicate Plug-In. For information on bouncing, refer to the *Mixing* chapter in the *Pro Tools Reference Guide*.

---

## Setting MIDI Channels

MIDI tracks can be assigned to one or more MIDI channels with the Device/Channel selector. When assigned to multiple channels, all material in the track is sent to all assigned channels.

MIDI Tracks in Pro Tools can not contain multiple channels of MIDI data.

### To assign all regions on a MIDI track to a specific MIDI channel:

1 Click on the track's MIDI Device/Channel Selector and assign a device and channel from the pop-up menu. Channels already assigned to another track appear bold in this menu.

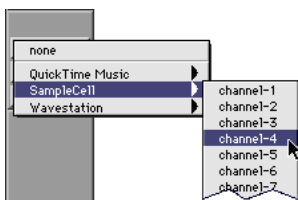

*MIDI Device/Channel selector*

To assign multiple destinations to a single MIDI track, Shift-click the MIDI Device/Channel Selector and select additional channels from any device.

For details on recording and importing MIDI data, see *Chapter 10: MIDI Recording*.

---

## Adjusting Track Volume and Pan

In the Mix window, each track has its own Volume fader and Pan slider for adjusting the track's playback volume and stereo placement. (Panning controls for audio tracks are only available if your session is set to Stereo Mix Outputs mode.) On audio tracks, the volume selector controls the output level of the track on your system's Audio Interface or system output jacks.

On MIDI tracks, it controls MIDI volume (controller 7) on MIDI instruments that support this feature. If a track has regions with MIDI volume controller data (created in the original sequence), its volume will be controlled by that data.

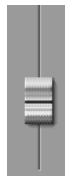

*Track Level fader*

### To adjust the volume of a track:

■ Drag the slider to the desired level. It has a range of  $\infty$  (no output) to +6dB of gain.



*The Pan Slider*

### To adjust the pan value of a track:

■ Drag the slider to the desired level. It has a range of <100 (full left) to 100> (full right).

Panning a track full right or full left sends it to a single output channel.

---

## Soloing and Muting Tracks

The Solo and Mute buttons can be engaged at any time during playback.

The Solo and Mute buttons affect MIDI as well as audio tracks. It is possible to have more than one track soloed or muted at the same time in a session.

Grouping affects mute and solo behavior as well. Normally, muting or soloing a track that is a member of an active mix group will mute or solo all other tracks that are a member of that active mix group as well. However, by changing the Mute and Solo settings in the Pro Tools Preferences dialog, you can disable this behavior.

### To disable group muting of tracks:

- 1 Choose Setups > Preferences, and click Automation.
- 2 Deselect the Mutes Follow Mix Groups option, and click OK.

With this option deselected, muting a track that is a member of an active group does not affect other members of the group.

### To disable group soloing of tracks:

- 1 Choose Setups > Preferences, and click Automation.
- 2 Deselect the Solos Follow Mix Groups option, and click OK.

With this option deselected, soloing a track that is a member of an active group does not affect other members of the group.

## Mute Frees Voice and Mute Lag Time

If you select Operations > Mute Frees Voice, a muted track's voice will be allocated to the next highest priority track assigned to the same voice. With this option enabled, there may be a delay (ranging in length from one to several seconds depending on the processing power of your system) between the time you mute or unmute a track and when you hear the effect on playback.

To avoid this delay, make sure that the Mute Frees Voice option is disabled. Another factor than can cause delays is your DAE Playback Buffer Size setting. Playback Buffer Size is set from DAE's File menu (Macintosh), or by choosing Setups > DAE Buffer Size (Windows). The larger the playback buffer you choose, the longer the potential lag time between the time you click the Mute button and the onset of muting.

## Solo Button

The solo button mutes other tracks so that the chosen track can be auditioned alone. Normally solos are "latched," that is, pressing subsequent solo buttons adds them to the soloed mix of tracks. Pro Tools allows you to "unlatch" solos, so that pressing a solo will mute all tracks except the track you have just soloed.



### **To solo a track:**

- 1 Click the Solo button on the track. The button is highlighted and all other tracks are muted.
- 2 Click the Solo button again to turn off the solo function.

### **To unlatch solo buttons:**

- 1 Choose Setups > Preferences and click Operation.
- 2 Deselect the Latch Solo Buttons option and click Done. With this option disabled, pressing a Solo button mutes all tracks except the track you have just soloed.

### **Solo Safe Mode**

Pro Tools also allows you to *solo safe* a track. This prevents the track from being muted even if you solo other tracks. This feature is useful for tracks such as Auxiliary Inputs that are being used as effects returns, allowing the effects track to remain in a mix even when other tracks are soloed. It is also useful to solo-safe MIDI tracks so that their playback is not affected when you solo audio tracks.

### **To solo safe a track:**

- Command-click (Macintosh) or Control-click (Windows) the Solo button on the desired track. This prevents the track from being muted even if you solo other tracks.

### **To return a solo safe track to normal:**

- Command-click (Macintosh) or Control-click (Windows) the Solo button on the track again.

### **Mute Button**

The mute button silences a chosen track. More than one track can be muted at one time. If Operations > Mute Frees Voice is enabled, muting a track will allocate its voice to the next highest priority virtual track in your session.

### **To mute a track:**

- Click the Mute button on the track. The track will appear grayed-out and be muted.

### **To unmute a track:**

- Click the Mute button again.

For information on the relationship between muting and voice assignments, see “Virtual Tracks, Voices, and Track Priority” on page 54.

---

## **Adjusting Track Width**

The Pro Tools Narrow Mix Window command allows you to view all tracks/channels in the Mix window at a reduced width to conserve screen space in a large session.

### **To reduce the width of tracks in the Mix window:**

- Select Display > Narrow Mix Window.

### **To display tracks at normal width:**

- Deselect Display > Narrow Mix Window.

---

## Color Coding Tracks

The Pro Tools Color Code options in the Preferences dialog allow you to quickly identify tracks which are assigned to the same voice or group. Color coding of voices is particularly useful in sessions where you wish to make efficient use of virtual tracks. Since tracks assigned to the same voice share the same color, you can easily identify and arrange regions so that they do not overlap or conflict with other regions on tracks assigned to the same voice.

### To color code tracks by voice assignment:

- 1 Choose Setups > Preferences and click Display.
- 2 Select “Color Code Voices and MIDI Channels in Edit Window,” and click Done. This color codes tracks according to voice assignment, giving each voice a different color.

### To color code tracks by group:

- 1 Choose Setups > Preferences and click Display.
- 2 Select “Color Code Groups in Edit Window,” and click Done. This color codes tracks according to their group assignment. To be color coded, the track must be part of an active group.

### To turn off color coding:

- 1 Choose Setups > Preferences and click Display.
- 2 Select No Color Code in Edit Window, and click Done.

---

## Grouping Tracks

Pro Tools provides a relative grouping function for linking channels and their controls. Groups can be applied to either the Mix or Edit window, or both.

Groups are useful for editing several tracks in exactly the same way, or for mixing several tracks (such as a pair of stereo tracks or a submix) while keeping them at the same relative volume level.

Pro Tools provides the following grouping features:

- Up to 26 different groups
- Nested groups (subgroups within groups)
- Grouped faders/controllers preserve their levels relative to each other

Grouping can affect the following track parameters:

- Volume levels
- Solos
- Mutes
- Automation modes
- Track display format
- Track height
- Editing functions

Grouping does not affect these parameters:

- Record enables
- Panning
- Send levels, panning and mutes
- Voice assignment
- Output assignment
- Creating Plug-In instances

## Using the Groups List

The Pro Tools grouping functions are located at the left side of your screen in the Groups List. This scrolling window contains the names of all the groups in your session, as well as a pop-up menu for accessing grouping commands. From this menu, you can select and enable groups.

By default, every session has a group named *All*, which includes every track and channel in the session. The *All* group cannot be edited or deleted.

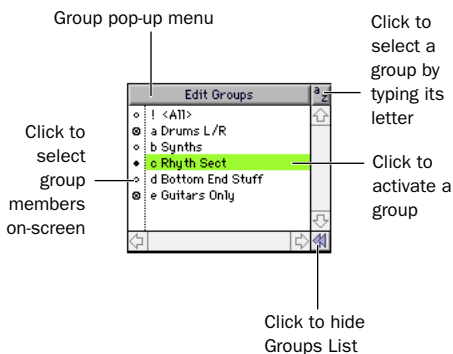

### The Groups List

To the left of each name in the Groups List is a letter denoting its Group ID (“a” through “z”), and to the left of that, a symbol indicating whether that group is selected in the currently active window (either the Edit or Mix window). These symbols indicate the following:

| ◦ | a Rhyth Sect

The filled-in circle symbol indicates that all members of the group are currently selected.

| ◦ | a Rhyth Sect

The hollow circle symbol indicates that only some members of the group are currently selected.

| ● | a Rhyth Sect

The circle with a dot symbol indicates that all members of the group are currently selected, plus additional members *outside* the group.

## The Groups Pop-up Menu

The Groups pop-up menu contains commands that allow you to create, delete and suspend groups. These commands are as follows:

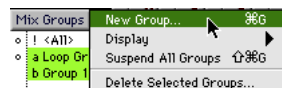

### The Group pop-up menu

**New Group** This command allows you to create a new group. You must first select two or more tracks/channel strips on screen to do this.

**Display** This command allows you to toggle the Groups List display to either Mix Groups or Edit Groups. If all of your groups apply to both Editing and Mixing, the Groups List will be the same for both.

**Suspend All Groups** This command allows you to temporarily toggle all active groups off.

**Delete Selected Groups** This command allows you to permanently remove a group from the Groups List. You must first select a Group Name in the Groups List to do this.

---

## Enabling Grouping

Editing operations are not applied to members of a group that are hidden with the Show/Hide Tracks List. Mix operations (with the exception of Record-enable) are applied to hidden tracks.

Pro Tools allows you to create separate groups for editing and mixing. You set this option when you use the New Group command. Groups that apply to both editing and mixing can be decoupled.

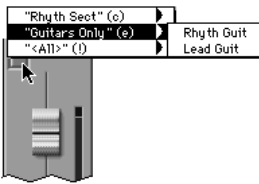

*Displaying a track's group membership*

### To enable a group:

- In the Groups List, click the name of the group you want to enable. The group name is highlighted to indicate that it is enabled.

To enable additional groups, click their names in the Groups List. It is not necessary to Shift-click to enable or disable multiple groups.

Moving a fader of a group member will cause all other group members to move relative to it. If a fader belongs to multiple groups, and the groups conflict when faders are moved, the fader will follow the top-most or "parent" group that it belongs to.

### To disable a group:

- In the Groups List, click the name of the group you want to disable. The group name is unhighlighted to indicate that it is not enabled.

## Keyboard Selection of Groups

If the Groups List Key focus is enabled, you can type a Group ID letter and Pro Tools will automatically enable that group.

### To enable and use the Groups List Key focus:

- 1 Click the a-z button in upper right of the Groups List.



*Groups List Key focus enabled*

- 2 Type Group ID letter (a-z) of the region to automatically enable it.

---

## Creating a Group

**To create a group:**

- 1 Hold down the Shift key and select the tracks you wish to include in the group.



*Selecting tracks to be grouped*

- 2 Choose File > Group Selected Tracks.
- 3 Enter a name for the group and choose a Group ID (“a” - “z”).



*The New Group dialog*

- 4 Choose the type of group to create: Edit Group, Mix Group, or Edit and Mix Group.
- 5 Click OK to add the new group to the Groups List.

## Changing the Members of a Group

You can add or remove members from a group at any time.

**To change the members of a group:**

- 1 Hold down the Shift key and select the tracks to include in the group.
- 2 Choose New Group from the Group pop-up menu.
- 3 In the dialog that appears, select the Group ID that you want to update.
- 4 Click OK. The new group definition overwrites the original definition.

## Renaming a Group

You can rename a group at any time.

**To rename a group:**

- 1 In the Groups List, double-click to the left of the group’s name (in the area with the circular symbols).
- 2 In the dialog that appears, enter a new name for the group. (If you wish to change the group’s type, you can also do so here.)
- 3 Click OK. The group is renamed in the Groups List.

## Deleting a Group

You can delete a group at any time.

**To delete a group:**

- 1 In the Groups List, select the name of the group (or groups) you wish to delete.
- 2 Click the Group pop-up menu and choose Delete Selected Groups. You cannot undo this action.

## Linking Mix and Edit Groupings

The “Link Mix and Edit Group Enables” option links group enabling between the Mix and Edit windows.

Pro Tools allows you to create groups that are *both* Mix and Edit groups. but in some cases you may prefer not to link enabling of Mix and Edit groups. For example, when you are using the Mix window for mixing, you may prefer to work with large, nested groups. However, in the Edit window, you may want to perform editing tasks within a smaller group. You could disable the Link Mix and Edit Group Enables preference. This would allow you to work with different groups in the two windows.

### To unlink mix and edit groups:

- 1 Choose Setups > Preferences and click Operation.
- 2 Deselect the “Link Mix and Edit Group Enables” option and click Done.

## chapter 7

# File Management and Compatibility

The various Pro Tools systems require that you keep certain files on specific hard drives in order for these systems to function properly. Observe the following file management rules:

### Macintosh

- ◆ On all Macintosh Pro Tools Systems, the Pro Tools software should reside on your Start-up drive (the drive that contains your System folder and other System-related files).
- ◆ On Pro Tools 24 MIX and Pro Tools 24 systems, data files (such as session files, audio files and fade files) can be located on any compatible drive connected to the internal SCSI bus or the external SCSI bus of your computer, or to a SCSI accelerator card in your computer.
- ◆ On Pro Tools III systems, data files (such as session files, audio files and fade files) must be located on a compatible drive which is connected to your Disk I/O SCSI chain.
- ◆ On Pro Tools LE systems, data files can be located on any compatible hard drive connected to your computer's internal or external SCSI bus.

### Windows NT

- ◆ On all Windows NT Pro Tools Systems, the Pro Tools software should reside on your system boot drive (the drive that contains your System files).
- ◆ On all Windows NT Pro Tools Systems, data files should be located on a compatible SCSI drive connected to the SCSI bus of your computer, or to a SCSI accelerator card in your computer.

---

## Locating Audio Files

### (Windows NT Systems Only)

When you open a session, if Pro Tools is unable to locate audio files contained in the session, it will post a Find File dialog.

Pro Tools for Windows NT tags each audio file in a session with a unique identifier that allows it to distinguish a particular file even if its name or location have changed.

In cases where the unique identifier is not present (for example, with files imported from a Macintosh session), Pro Tools can identify an audio file using other file attributes, such as sample rate, bit depth, file length, and creation or modification date. Pro Tools will search for files with similar attributes, and list potential matches in the Candidate Files list.

### To locate an audio file:

**1** In most cases, you can find files created or modified by Pro Tools for Windows NT by clicking Look in Current Folder or Look on All Mounted Volumes. To search in all subfolders of the current folder, select Include Subfolders.

**2** If Pro Tools is unable to find the target file, use the Folder or Files menus or the Navigation Toolbar in the upper left of the Find File dialog to look in directories on your audio drives. You can limit the search to files of a certain type by selecting from the Files of Type menu. Potential matches will appear in the Candidate Files list on the right.

**3** Select a candidate file to view its attributes in the File Info area. To audition a selected audio file, click Play and adjust the Play Position slider to choose the playback location in the file.

**4** If you determine that a file in the Candidate Files list is not the target file, click Skip. To eliminate all files in the list, click Skip All.

**5** Click Down to move to the next file in the list.

**6** When you have located the target file, click Open.

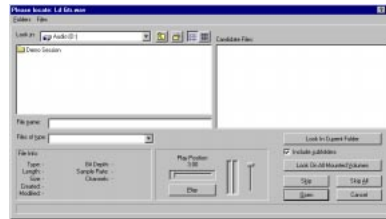

*Find File dialog*

---

## WAV File Compatibility

### Convert all imported WAV files to AES31/BroadcastWave

Pro Tools always creates AES31/Broadcast compliant WAV files when the file originates in Pro Tools. This option, accessed by choosing Setups > Preferences > Compatibility, applies to all *imported* WAV files, making them compliant with the AES31/EBU Broadcast standard.

AES31/BroadcastWave is a variant of the standard audio WAV file type. The AES31 format contains additional information beyond the raw PCM audio data such as SMPTE time stamps.



This variant complies with the new standards set down by the EBU (European Broadcasters Union), and the AES (Audio Engineering Society). Choose this option to ensure compatibility with other workstations that recognize this new standard file type.

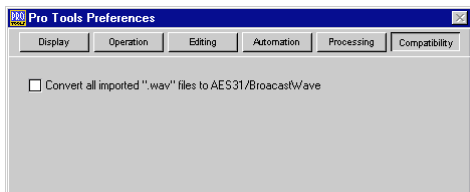

*Compatibility Preference Setting*

---

## Naming Files, Playlists and Regions

To ensure portability of your Pro Tools sessions between Windows and Macintosh platforms, you will want to name your session files, bounced audio files, regions and playlists carefully.

While it is probably best to avoid using any special characters or punctuation marks in your filenames, the ones that can cause problems are listed below.

**Avoid using the following characters since they cannot be used in Windows filenames:**

/ (slash)

\ (backslash)

: (colon)

\* (asterisk)

? (question mark)

“ (quotation marks)

< (less-than symbol)

> (greater-than symbol)

| (vertical line or pipe)

Filenames with non-ASCII characters, such as those created on the Macintosh by typing combinations with the Option or Control keys (for example, letters with diacritical marks, like é, ù, or ç), are also illegal in Windows.

If you open a Macintosh session which contains playlists or regions with these characters, any illegal characters will be changed to “\_” (underscore) when you perform an operation that uses that filename (such as exporting a region or AudioSuite processing).

The “:” (colon) is also an illegal character on the Macintosh, since it is used as a separator in Mac OS pathnames.



# **Part III**

## **Recording**



## chapter 8

# Record Setup

Before you start recording, make sure your Pro Tools system is connected and configured properly. For details on connecting Pro Tools to your studio, refer to the *Pro Tools Hardware Installation Guide* that came with your system.

While some of the information in this chapter is relevant to recording MIDI, there are more specific setup details for MIDI recording in *Chapter 10: MIDI Recording*.

---

## Input Connections and Audio Levels

Most Digidesign audio interfaces operate as line-level devices and offer no pre-amplification. You must therefore adjust the level of an input signal to line level before it reaches Pro Tools. Low-level sources like microphones and electric guitars need to be pre-amplified. You can do this with a quality mixing board or dedicated preamp.

---

\* The Digi 001 is an exception to this rule. Its I/O Box has two inputs with preamps, to which you can connect low-level signals, and six additional inputs with “input gain.”

---

Volume and pan controls for tracks in Pro Tools only affect monitoring levels—not the recording input gain. The LED indicators on audio interfaces indicate both full-code (highest level before clipping) and true clipping of Pro Tools output signals. The on-screen meters in the Pro Tools application indicate only true clipping.

### Digital Clipping

Clipping occurs when you feed a signal to a recorder or mixer that is louder or “hotter” than the device allows. On many analog tape decks, a little clipping adds a perceived warmth to the sound due to tape compression. In digital recording, however, clipping causes digital distortion, which is undesirable and should always be avoided.

### Set Input Levels High But Don't Clip

When you feed a signal into any audio recording system, including Pro Tools, you need to adjust the input level to optimize the dynamic range. Adjust the input signal to register as high as possible on your input meter without triggering the clipping indicator. If the input level is too low, you will not take full advantage of the dynamic

range of your Pro Tools system. If the input level is too high, however, it will be clipped.

## Calibration Mode

You can use the Calibration Mode in Pro Tools to adjust the input and output levels for your audio interface so they match those of your mixing console and other audio devices in your studio.

For more information on Calibration Mode, see the *TDM Hardware Installation Guide*.

---

## Record Enabling Tracks

To record to a track you must first record-enable it. While you can have multiple audio tracks record-enabled (for simultaneously recording more than one track), there can only be one MIDI track record-enabled at a time. The record-enabled MIDI track can, however, be switched on the fly while recording.



*Record-enabled audio track*

### To record enable an audio or MIDI track:

- From either the Edit or Mix window, click the track's Record button.

Click again to take the track out of record-enabled mode.

### To record enable all audio tracks:

- Option-click (Macintosh) or Alt-click (Windows) the Record button on any audio track.

Option-click (Macintosh) or Alt-click (Windows) again to take all audio tracks out of record-enabled mode.

### To record enable all selected audio tracks:

- Shift-Option-click (Macintosh) or Shift-Alt-click (Windows) the Record button on any audio track.

Shift-Option-click (Macintosh) or Shift-Alt-click (Windows) again to take all selected audio tracks out of record-enabled mode.

---

\* Multiple tracks are *selected* by Shift-clicking their track names.

---

\* While record enabling does not affect audio tracks that are grouped, you *can* select all tracks in a group by clicking directly to the left of the group's name in the Groups List. Then you can Shift-Option-click (Macintosh) or Shift-Alt-click (Windows) to record enable all selected tracks.

---

### To record enable a different MIDI track on the fly:

- While pressing Option (Macintosh) or Alt (Windows), press the Up/Down arrows to record-enable the previous or next MIDI track.

– or –

Click the Record button of the MIDI track you want to record enable. The previous record track is taken out of record-enabled mode.

## Latch Record Mode

When the option for Latch Record Enable Buttons is selected (in the Operations Preferences), you can record enable (latch) additional audio tracks by clicking their Record buttons. Previously record-enabled tracks remain record-enabled.

When Latch Record Enable Buttons is deselected, record-enabling a subsequent audio track takes the previously record-enabled track out of record-enabled mode.

---

\* When the option for Latch Record Enable Buttons is deselected, you can still Shift-click the Record buttons on multiple audio tracks to record enable them.

---

## Record Safe Mode

When tracks are in Record Safe mode, it is not possible to record enable them, and therefore not possible to record to them. Use Record Safe mode to protect important track recordings.

### To put an audio or MIDI track in Record Safe mode:

- Command-click (Macintosh) or Control-click (Windows) the track's Record button.

Command-click (Macintosh) or Control-click (Windows) again to take the track out of Record Safe mode.

### To put all tracks in Record Safe mode:

- Command-Option-click (Macintosh) or Control-Alt-click (Windows) the Record button on any track.

Command-Option-click (Macintosh) or Control-Alt-click (Windows) again to take all tracks out of Record Safe mode.

### To put all currently selected tracks into Record Safe mode:

- Command-Option-Shift-click (Macintosh) or Control-Alt-Shift-click (Windows) the Record button on any of the selected tracks to toggle them in and out of Record Safe mode.

---

## Monitoring Modes

Pro Tools offers two modes of input monitoring, *Auto Input Monitoring* or *Input Only Monitoring* (chosen from the Operations menu), which determine how input signals are monitored while recording audio.

## Auto Input Monitoring

In this mode, when session playback is stopped, Pro Tools monitors audio input. When playback is started for a punch-in, Pro Tools monitors existing track material up until the punch point. While punched in, the input signal is monitored. On punch-out, monitoring switches back to the existing track material. This is similar to the auto-switching logic found on digital and analog multitrack tape machines.

---

▲ When using Auto Input Monitoring, the switch back to monitoring track material on punch-out is not instantaneous. To get instantaneous monitor switching on punch-out, use QuickPunch (see "Using QuickPunch" on page 113).

---

## Input Only Monitoring

In this mode, when a track is record-enabled, Pro Tools monitors audio input only, regardless of any punch in/out selection.

## Monitor Levels for Record and Playback

Pro Tools allows you to set two different fader levels for each audio track: one for when the track is record-enabled, and one for when it is *not* record-enabled. This lets you adjust levels for playback and configure a different set of levels for monitoring while recording.

Pro Tools remembers these two states for fader levels automatically. If you adjust a fader when a track is record-enabled and then take the track out of record-enabled mode, the fader updates accordingly.

When audio tracks are record-enabled, their volume faders in the Mix window turn red, indicating that the record monitor level is active.

---

## Monitoring Latency

### (Pro Tools LE Only)

Because Pro Tools LE uses the host processor in your computer for audio processing, playback, and recording, there is a small amount of audio delay, or latency, in the system. This latency amount is related to the Hardware Buffer Size—the larger the buffer size, the larger the latency.

While there may be times when you want a larger Buffer Size, for the sake of higher track counts with more Plug-Ins, you'll generally want a smaller Buffer Size when recording audio that is monitored through your Digi 001 or Audiomedia III.

If you are monitoring the audio material you're recording with an external mixer, you will not hear any latency.

### To set the Hardware Buffer Size:

- 1 Choose Setups > Hardware.
- 2 Choose the number of samples from the Hardware Buffer Size pop-up.

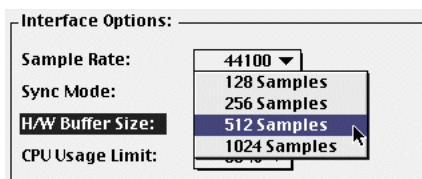

### Hardware Buffer Size

- 3 Click OK.

---

▲ Computers with slower CPUs may not be able to use the 128 Buffer Size without encountering performance errors.

---



▲ If have a SampleCell II Plus card, a buffer size of 128 should not be used when running the SampleCell Editor at the same time as Pro Tools LE. Use a larger buffer setting to avoid performance errors.

The following table lists the amount of monitoring latency (in ms) you can expect from the four Buffer Sizes.

Sample rate (kHz)	Buffer Size (samples)	Latency (ms)	Use for:
44.1	128	2.9	recording drums and other timing-critical instruments
	256	5.8	recording vocals and instruments with slower attacks (bass, guitar, etc.)
	512	11.6	mixing with 24 tracks
	1024	23.2	final mixdown or many plug-ins
48	128	2.7	recording drums and other timing-critical instruments
	256	5.3	recording vocals and instruments with slower attacks (bass, guitar, etc.)
	512	10.7	mixing with 24 tracks
	1024	21.3	final mixdown or many plug-ins

*How Hardware Buffer settings affect latency*

## Low Latency Monitoring

### (Pro Tools LE Only)

You can reduce the amount of monitoring latency for Pro Tools LE systems by reducing the Hardware Buffer Size. However, even at the smallest Buffer Size, there is still some latency. In addition, reducing the Buffer Size limits the number of simultaneous audio tracks you can record without encountering performance errors.

Digi 001 and Audiomedia III systems can use the Low Latency Monitoring option to record with an extremely small amount of monitoring latency, to as many tracks as each system supports.

### To use Low Latency Monitoring:

- 1 Record enable the desired audio tracks (or Auxiliary Inputs) by clicking their Record buttons. Only tracks with inputs set to an audio interface (not a bus) use Low Latency Monitoring.
- 2 From the Output Selector, assign each track to either Output 1 or Output 2. Only tracks assigned to these outputs use Low Latency Monitoring.
- 3 Select Operations > Low Latency Monitoring.

When Low Latency Monitoring is enabled, any plug-ins and sends assigned to record-enabled tracks (routed to Outputs 1–2) are automatically bypassed, and must remain bypassed. Also, these tracks will not register on meters for Master Faders.

## Low Latency Monitoring and Bounce To Disk

With Low Latency Monitoring Enabled, only audio tracks are included with the Bounce To Disk command—Auxiliary Input tracks are ignored.

To record Auxiliary Inputs with Low Latency Monitoring enabled, you must record the material in real time.

---

## Track Names

When creating new audio and MIDI tracks, Pro Tools names them as either “Audio” or “MIDI” and numbers them consecutively. For instance, when you create 2 new audio tracks, their default names are “Audio 1” and “Audio 2.” You can rename tracks and also log comments for each track.

### To rename a track:

- 1 In the Edit or Mix window, double-click the Track Name.
- 2 In the Track Name/Comments dialog, type a new track name.

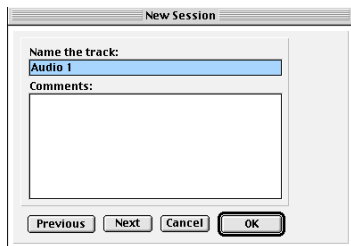

*Track Name/Comments dialog*

- 3 If desired, type comments for the track in the Comments text box. Click Previous or Next to rename another displayed track.

---

\* To switch tracks in the Track Name/Comments dialog, you can also press Command (Macintosh) or Control (Windows) and use the Up/Down Arrows.

---

- 4 When you are finished, click OK.

## Default Names for Audio Files and Regions

When recording to an audio track, the resulting file and region names are based on the name of the track. For instance, after recording for the first time on a track called “Electric Gtr,” an audio file is written to your hard drive with the name “Electric Gtr-01.” In addition, a region appears in the Audio Regions List with the name “Electric Gtr-01-00.”

Subsequent record takes on the same track are named identically but with the first set of digits (indicating the take number) incremented. The second set of digits is only used for region naming and indicate a region *auto-created* from an edit.

---

☞ The QuickPunch record mode uses a slightly different method for numbering regions. For details, see “Region and Take Numbering with QuickPunch” on page 116.

---

When recording MIDI tracks, a similar naming scheme is used, though with only one set of digits. For instance, after recording to a track called “Synth 1,” a region is created called “Synth 1-01.” Subsequent regions for that track, generating either from additional record takes or region edits, are numbered sequentially.

---

## Recording to Multiple Hard Drives

To increase system performance, Pro Tools lets you record each track to different hard drive.

Since Pro Tools III systems use a Disk I/O card for SCSI connections, it may not be necessary to allocate tracks to multiple drives. However, using Round Robin Allocation can minimize the performance burden on a single drive.

### To record to multiple hard drives:

- 1 Choose Setups > Disk Allocation.
- 2 In the Disk Allocation dialog, assign a hard drive for each track by clicking in the Record Drive column.

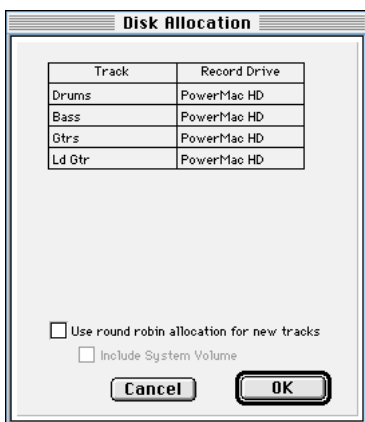

*Disk Allocation dialog*

To assign all tracks to the same hard drive, press Option (Macintosh) or Alt (Windows) while selecting a drive name.

3 To automatically distribute any newly created tracks among the drives connected to your system, select “Use Round Robin Allocation for New Tracks.”

If you are using Round Robin Allocation and want audio to be recorded to your system’s startup drive, select Include System Volume (see “Recording to the System Volume” on page 80 for details).

4 When you are finished, Click OK.

When recording, each track is routed to the selected drive. If Round Robin Allocation is enabled, new tracks are automatically allocated to subsequent hard drives. A folder with the session name is created on each hard drive, containing folders for “Audio Files” and “Fade Files.”

To save Disk Allocation settings for use with future sessions, save the session as a template. For details, see “Creating Custom Session Templates” on page 48.

## Disk Allocation and Cross-Platform Sessions

Pro Tools for Windows supports recording and playback of audio from multiple hard drives, but to ensure cross-platform operation, it also requires that Macintosh Pro Tools sessions and their associated audio files be on Macintosh-formatted (HFS) drives.

Similarly, Windows sessions and their associated audio files must reside on Windows-formatted (FAT16) drives. If you want to share sessions between Windows and Macintosh platforms, consider these restrictions when allocating tracks to drives.

## Reallocating Tracks

When opening a session where some of the previously assigned hard drives are no longer available (or don't match the current session platform), Pro Tools automatically reassigns tracks to the volume where the session file is stored. In such cases, Pro Tools gives you the option of reallocating tracks to other drives.

## Recording to the System Volume

Though Pro Tools will let you record to your system hard drive, this is generally not recommended. Performance for audio recording and playback on system drives is worse than on non-system hard drives.

You should record to system drives only when absolutely necessary—if your computer system has just the one hard drive, or if your other hard drives are completely out of space.

---

## Allocating Hard Drive Space for Recording

The Operation Preference for Open Ended Record Allocation determines how much of your available hard drive space is allocated for recording.

When this preference is set to Use All Available Space, the drive's entire available space is allocated. This can slow down the recording process for hard drives that use certain file systems, including HFS+ and NTFS.

In such cases, you can reduce the time it takes to begin recording by allocating only a portion of your hard drive.

### To allocate a portion of your hard drive for recording:

- 1 Choose Setups > Preferences and click Operation.
- 2 Under the Open Ended Record Allocation option, select Limit To and enter a number of minutes to be allocated.

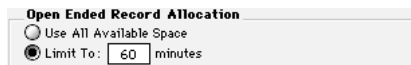

### *Open Ended Record Allocation, Operation Preference*

The number of minutes specified is allocated for each record-enabled track. You may find it necessary to experiment with this number to achieve the desired performance for recording.

- 3 When you are finished, click Done.

---

## Record Modes

For recording audio, Pro Tools has four record modes:

- *Normal* Nondestructive Record
- Destructive Record
- Loop Record
- QuickPunch

To enable Destructive Record, Loop Record, or QuickPunch, select them from the Operations menu. If none of these record modes are selected, Pro Tools is in normal Nondestructive Record mode.

The record mode can also be switched by Control-clicking (Macintosh) or Right-clicking (Windows) the Record button in the Transport window. This cycles through the four modes with the Record button changing to indicate the currently selected mode: blank for Nondestructive, “D” for Destructive, a loop symbol for Loop Record, and “Q” for QuickPunch.



*Destructive Record mode enabled*

### Nondestructive Record Mode

In normal Nondestructive Record mode, Pro Tools records audio non-destructively, which means that if you record over a track's existing regions, the audio is not erased from your hard drive. Both the new and old audio remain on your hard drive, available as regions from the Audio Regions List.

In Nondestructive Record mode, the record range is defined by selecting a range in the Ruler or in a track's playlist, or by specifying

start and end points in the Transport window. If there is no selection, recording begins from the current cursor location and continues until the Transport's Stop button is clicked.

---

▲ To set a record range by selecting within a track's playlist, the Edit and Timeline selections must be linked.

---

The pre/post-roll settings allow material to be heard up to and after the start and end points, which is useful when punch recording (see “Punch Recording Audio” on page 92 for details).

### Destructive Record Mode

In Destructive Record mode, recording over existing regions replaces the original audio permanently, which allows you to preserve hard drive space. However, if you have sufficient drive space, it is usually best to use Pro Tools in Nondestructive Record mode, to avoid losing any previously recorded material.

---

☞ When working in normal Nondestructive Record mode, you can preserve disk space by removing unwanted record takes (see “Removing Unwanted Regions” on page 198) and compacting audio files (see “Compacting an Audio File” on page 199).

---

When defining the record range and setting pre- and post-roll, Destructive Record mode works the same as Nondestructive mode.

Unlike the other record modes, it is not possible to cancel record takes when using Destructive Record mode (see “Canceling a Record Take” on page 88).

## Loop Record Mode

Loop Record mode allows you to record take after take (non-destructively) while the same section of audio repeats. This is a convenient technique for quickly recording multiple takes of a part without losing spontaneity.

The time range that is looped and re-recorded—which must be at least one second in length—is defined by selecting a range in the Ruler or in a track’s playlist, or by specifying start and end points in the Transport window. The pre-roll setting, if enabled, is used during the first record pass, but on each successive loop the pre/post-roll times are ignored.

---

▲ To set a record range by selecting within a track’s playlist, the Edit and Timeline selections must be linked.

---

When using Loop Record mode, each successive take appears as a region in the Audio Regions List and each is numbered sequentially. The various takes, which are identical in length and start time, are easily auditioned and placed in the track at the correct location with the Takes List pop-up menu (see “Auditioning Record Takes” on page 94).

## QuickPunch

QuickPunch gives you the ability to instantaneously *punch in* (initiate recording) and *punch out* (stop recording) on record-enabled audio tracks during playback by clicking the Transport’s Record button. Recording with QuickPunch is nondestructive.

When using QuickPunch, Pro Tools begins recording a new file when playback begins, automatically generating regions in that file at each punch in/out point. Up to 100 of these “running punches” can be performed in a single pass.

Though you can punch record in the other record modes by manually specifying the record range, only QuickPunch provides instantaneous monitor switching on punch-out.

## The Record Modes and MIDI

In addition to the four record modes, there is also a MIDI Merge button in the Transport window that determines how MIDI is recorded. When enabled (*Merge* mode), recording over existing MIDI regions results in the new data being merged with the old. When the MIDI Merge button is disabled (*Replace* mode), the new material replaces the old.

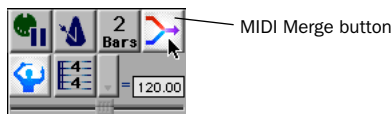

*MIDI Merge enabled*

MIDI recording works the same whether using Nondestructive or Destructive Record mode. In addition, QuickPunch does not need to be enabled to punch on the fly with MIDI—this capability is available in Nondestructive and Destructive Record modes.

Unlike audio, MIDI can be loop recorded when Operations > Loop Playback is enabled. In this mode, the state of the MIDI Merge toggle determines whether existing material is replaced or merged.

In almost all instances, recording MIDI is destructive (though you can undo a MIDI record pass), either overwriting or adding to region material. One exception to this rule is when Loop Record mode is enabled; in this mode, existing track regions are replaced with new regions when new material is recorded. The old regions remain intact and available from the MIDI Regions List, and from the Takes List pop-up. In Loop Record mode, MIDI Merge has no effect, so its button is dimmed.

---

## Recording with the Click

If you intend to work with MIDI tracks in your session, or if the audio you're working with is bar- and beat-oriented, you may record your tracks while listening to the *click*. This ensures that recorded material, both MIDI and audio, will align with the session's bar and beat boundaries.

When your track material lines up with the beats, you can take advantage of some useful editing functions in Pro Tools, such as quantizing MIDI and audio regions, quantizing individual MIDI notes, and copying and pasting measures and song sections in Grid mode.

---

☞ Material that is recorded without listening to the click can still be aligned to bar and beat boundaries in Pro Tools with the Identify Beat command. For details, see “Identify Beat Command” on page 230.

---

### To enable the click in the Transport:

**1** To view the MIDI controls in the Transport window, select Display > Transport Window Shows > MIDI Controls.

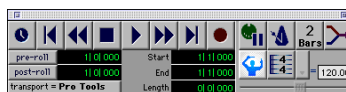

Transport Window with MIDI Controls

**2** In the Transport window, click the Click button so it becomes highlighted.



Click enabled

**3** To use a *countoff* when recording or playing, click the Countoff button in the Transport window so it too becomes highlighted.

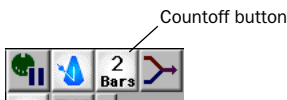

Countoff enabled

Hearing the countoff before recording is helpful in getting the feel for the tempo before you begin playing. The Countoff button in the Transport window displays the number of bars to be counted off.

---

▲ The countoff is ignored when Pro Tools is Online and syncing to SMPTE time code.

---

### To configure the click options:

- 1 Choose MIDI > Click Options.  
– or –

Double-click the Click or Countoff button in the Transport window.

- 2 In the Click/Countoff Options dialog, choose from the Output pop-up the port number (device) and channel that will play the click.

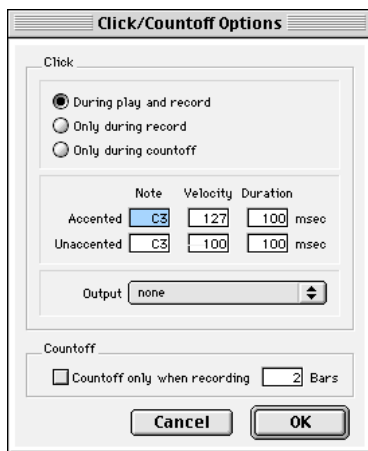

*Click/Countoff Options dialog*

- 3 For the accented and unaccented notes, specify the note, velocity, and duration.

When listening to the click in your Pro Tools sessions, the accented note sounds on the first beat of each measure and the unaccented note sounds on the remaining beats. Make sure the sound assigned to these notes has a sharp, percussive attack.

- 4 Select whether the click is heard “During play and record” or “Only during record.”

- 5 If using a countoff, specify the number of Bars to be counted off. To hear the countoff only when recording, select that option.

- 6 Click OK.

## Setting the Default Meter

When opening a new session in Pro Tools, the meter defaults to 4/4. If you intend to record with the click and are working with a different meter, make sure to set the default meter accordingly.

If a session’s meter does not match the music you’re recording, the accented clicks will not line up with what you’re playing, and, as a result, the recorded material may not align with the bars and beats in the Edit window.

Meter events, which can occur anywhere within a Pro Tools session, are stored in the Meter Track and appear in the Meter Ruler. Inserting and editing for meter events is discussed in “Meter Events” on page 233.

### To set the default meter for a session:

- 1 Choose Windows > Show Tempo/Meter.  
– or –

Double-click the Meter button in the Transport window.

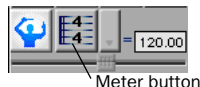



2 Enter the Meter you will use for the session and set the Location to 1|1|000 (so the inserted meter event replaces the default one).

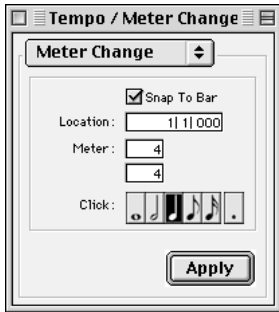

*Tempo/Meter Change window*

- 3 Choose a note value for the number of clicks to sound in each measure.
- 4 Click Apply to insert the new meter event.

## Setting the Default Tempo

When opening a new session in Pro Tools, the tempo defaults to 120 BPM. If you intend to record with the click and are working with a different tempo, make sure to set the default tempo accordingly. If you know the tempo you will use for the session, you can insert a tempo event at the beginning of the Tempo Track.

Tempo events, which can occur anywhere within a Pro Tools session, are stored in the Tempo Track and appear in the Tempo Ruler. Inserting and editing for tempo events is discussed in greater detail in “Tempo Events” on page 227.

### To insert a default tempo event:

- 1 Choose Windows > Show Tempo/Meter.
- 2 At the top of the Tempo/Meter Change window, choose Tempo Change from the pop-up menu.

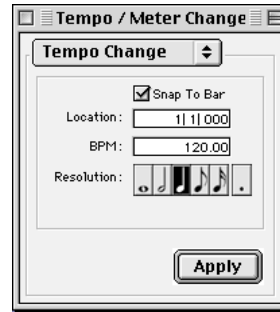

*Tempo/Meter Change window*

- 3 Enter the BPM value you will use for the session and set the Location to 1|1|000 (so the inserted tempo event replaces the default tempo).
- 4 To base the BPM value on something other than the default quarter-note, select the desired note value.
- 5 Click Apply to insert the new tempo event.

See “Default Tempo” on page 230 for more information on the default tempo.

## Using Manual Tempo Mode

In *Manual Tempo* mode, Pro Tools ignores the tempo events in the Tempo Track and instead plays back at the tempo displayed in the Transport window. The manual tempo can be set with the Tempo slider, or, if you’re not sure of the actual tempo, by tapping in the tempo.

▲ While you can adjust the Manual Tempo during playback, doing so will momentarily interrupt playback.

### To set the manual tempo with the Tempo slider:

- 1 To view the MIDI controls in the Transport window, select Display > Transport Window Shows > MIDI Controls.
- 2 In the Transport window, click the Conductor button so it becomes unhighlighted.



Conductor button

### Manual Tempo mode enabled

Pro Tools switches to Manual Tempo mode. In this mode, any tempo events in the Tempo Track are ignored.

- 3 To enter a new tempo, drag the horizontal Tempo slider in the Transport window.

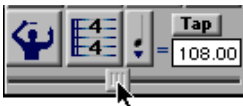

### Tempo slider

For finer resolution with the Tempo slider, press Command (Macintosh) or Control (Windows) while dragging.

- 4 To base the BPM value on something other than the default quarter-note, make the change in the Beat Value pop-up menu (just to the left of the Tap button).
- 5 To exit Manual Tempo mode and enable the Tempo Track, click the Conductor button in the Transport window so it becomes highlighted.

### To set the manual tempo with the Tap button:

- 1 To view the MIDI controls in the Transport window, select Display > Transport Window Shows > MIDI Controls.
- 2 In the Transport window, click the Conductor button so it becomes unhighlighted. Pro Tools switches to Manual Tempo mode. In this mode, any tempo events in the Tempo Track are ignored.
- 3 Click the Tap button repeatedly at the desired tempo.

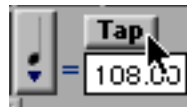

Tap button

– or –

Click in the Tempo field so it becomes highlighted and tap in the tempo by playing a note on your MIDI keyboard controller.

To compute the new tempo, Pro Tools requires at least four taps (each of which is displayed in the Tap area when received). The computed BPM value appears in the Transport's Tempo field.

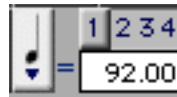

Tempo Taps as reflected in Transport

To lock in the new tempo, take Pro Tools out of Manual Tempo mode by clicking the Conductor button, then insert a tempo event (with the new tempo) at the beginning of the Tempo Track.

## chapter 9

# Basic Audio Recording

## Recording a Single Audio Track

When recording from a mono source, record to a single audio track in Pro Tools.

### To configure a new audio track for recording:

- 1 Connect a mono sound source to the appropriate input of your audio hardware.
- 2 From the Session Setup window, select the sample rate for your session.

If using inputs 1 or 2 of an audio interface, make sure to specify the format (analog or digital) in the pop-up menu for Ch 1–2.

- 3 Choose File > New Track and specify 1 Audio Track, then click Create.



*New Track dialog*

\* To auto-scroll the Track Type pop-up in the New Track dialog, press Command (Macintosh) or Control (Windows) and use the Up/Down Arrow keys.

- 4 Rename the new track as desired. Track names are used to auto-name recorded audio files and regions. For more information, see “Track Names” on page 78.

- 5 In the Mix Window, click the audio track’s Record button to record enable the track.

Volume faders for record-enabled audio tracks turn red to indicate they are functioning as record monitor levels.

- 6 In the Mix window, click on the track’s Input Selector and assign a hardware input.

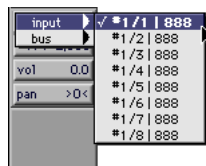

*Input Selector*

- 7 Adjust the output level of your sound source (instrument, mixer, or preamp). Monitor the track’s meter levels in Pro Tools to ensure that you get the highest possible signal without clipping.

- 8 In the Mix window, adjust the track’s volume and pan faders as desired. These settings are for monitoring purposes only and do not affect the recorded material.

### To record to the new audio track:

**1** Put Pro Tools in normal Nondestructive Record mode. In the Operations menu, deselect Destructive Record, Loop Record, and QuickPunch.

**2** If desired, enable the click and countoff in the Transport window. Also, make sure to specify the session's default meter and tempo. For details, see "Recording with the Click" on page 83.

**3** In the Transport window, click Return to Zero so the start/end times are cleared. This ensures that you'll start recording from the beginning of the track.

**4** Click Record in the Transport window. The Record button flashes.



*Record button*

**5** When you are ready to begin recording, click Play. If using a countoff, Pro Tools counts off the specified number of measures and then begins recording.

**6** When you have finished recording, click Stop in the Transport window.

The newly recorded audio is written to disk and appears as an audio region in the track's playlist. The new audio region also appears in the Audio Regions List.

### To play back the new audio track:

**1** Click the Record button for the audio track to take it out of record-enabled mode. The track's volume fader now functions as a playback level control.

**2** In the Transport window, click Return to Zero.

**3** Click Play in the Transport window to begin playback. Adjust the track's volume and pan faders as necessary.

### Record Shortcuts

You can also begin recording with the following keyboard shortcuts:

- Press F12
- Press Command+Spacebar
- Press 3 on the Numeric Keypad (when the Numeric Keypad Mode is set to Transport)

---

\* To initiate recording at half-speed, press Command+Shift+Spacebar (Macintosh) or Control+Shift+Spacebar (Windows). For details, see "Half-Speed Recording and Playback" on page 118.

---

### Canceling a Record Take

While recording it is possible to discard the current record take. This removes the audio (recorded up to that point) from your hard drive and deletes the region from the track's playlist. This capability is not available in Destructive Record mode.

#### To cancel a record take while recording:

- Press Command+period (Macintosh) or Control+period (Windows) before the Transport is stopped.

If using Loop Record mode, all takes from each record pass are discarded.

---

☞ Unlike audio recording, MIDI recordings can be undone after stopping the Transport. For details, see "Undo and MIDI Recording" on page 107.

---

---

## Stereo and Multiple-Track Recording

Pro Tools can record multiple audio tracks simultaneously, up to the track recording limits of your system. To record a stereo audio signal, record to two audio tracks.

### To record audio in stereo:

- 1 Connect the left and right outputs from your sound source to the appropriate inputs of your audio hardware.
- 2 Choose File > New Track and specify 2 Audio Tracks, then click Create.
- 3 Click the Record button for the first and second track to record enable them.

As long as the preference for Latch Record Enable Buttons is enabled, you can record enable subsequent audio tracks by clicking their Record buttons. Other tracks already record-enabled will remain so.

- 4 In the Mix window, use the Input Selector to assign the input for the first track to the hardware input for the left channel. Assign the second track to the hardware input for the right channel.
- 5 In the Mix window, set the pan fader for the first track to 100% left, then set the pan fader for the second track to 100% right.
- 6 Adjust the output level of your sound source (instrument, mixer, or preamp). Monitor the track's meter levels in Pro Tools to ensure that you get the highest possible signal without clipping.
- 7 In the Transport window, click Return to Zero so the start/end times are cleared. This ensures that you'll start recording from the beginning of the track.

8 Click Record in the Transport window. When you are ready to begin recording, click Play.

9 When you have finished recording, click Stop in the Transport window.

For each record-enabled track, a new audio file is written to disk and a new region is created and appears in the playlist. The new audio regions also appear in the Audio Regions List.

---

\* Create an Edit and Mix Group for the stereo pair so that edits, fader movements, and mutes are automatically applied to both tracks.

---

## Record Pause Mode

When recording a large number of tracks, or playing back a large number of tracks while recording, Pro Tools may take a little longer to begin recording. To avoid this delay, put Pro Tools in Record Pause mode before beginning to record.

### To record from Record Pause mode:

- 1 Click Record in the Transport window. The Record button flashes.
- 2 Option-click (Macintosh) or Alt-click (Windows) Play in the Transport window to put Pro Tools in Record Pause mode. The Play and Record buttons flash.
- 3 To begin recording instantaneously, click Play. When you have finished recording, click Stop in the Transport window.

---

\* You can also use Pause mode when recording or playing large numbers of tracks to speed up lock-up time when syncing to time code.

---

---

## Recording Additional Takes

After recording to an audio track, you can record additional takes into the same track. However, if you record these additional takes in Destructive Record mode, the audio residing on your hard drive from the previous takes will be permanently lost.

To keep the audio from previous takes, record the new takes non-destructively in normal Nondestructive Record mode.

---

☞ For details on audio file and region names for new takes, see “Track Names” on page 78.

---

### To non-destructively record a new take on the same track:

**1** Put Pro Tools in normal Nondestructive Record mode. In the Operations menu, deselect Destructive Record, Loop Record, and QuickPunch.

**2** Make sure the track containing the previous take is still record-enabled.

**3** Make sure to select Operations > Link Edit and Timeline Selection. This lets you set the record start time by clicking anywhere in the track’s playlist.

**4** To record from the beginning of the track, click Return to Zero in the Transport window.

– or –

Click anywhere in the track’s playlist to begin recording from that point.

---

☞ To record a specific track range, with precise start and end points, see “Punch Recording Audio” on page 92.

---

**5** Click Record in the Transport window. When you are ready to begin recording, click Play.

**6** When you have finished recording, click Stop in the Transport window.

An audio file for the new take is written to disk and appears as an audio region in the track’s playlist. The new audio region also appears in the Audio Regions List.

The audio from the original take remains on your hard drive, and is still available as a region in the Audio Regions List.

### To destructively record over a previous take:

**1** Select Operations > Destructive Record. When using Destructive Record mode, a “D” appears in the Record button.



*Destructive Record mode enabled*

**2** Make sure the track containing the previous take is still record-enabled.

**3** Make sure to select Operations > Link Edit and Timeline Selection. This lets you set the record start time by clicking anywhere in the track’s playlist.

**4** To record from the beginning of the track, click Return to Zero in the Transport window.

– or –

Click anywhere in the track’s playlist to begin recording from that point.

---

☞ To record a specific track range, with precise start and end points, see “Punch Recording Audio” on page 92.

---

5 Click Record in the Transport window. When you are ready to begin recording, click Play.

6 When you have finished recording, click Stop in the Transport window.

The audio for the new take is written to disk, permanently overwriting the original. The new material replaces the original material within the existing region.

### Appending New Material to the End of a Track

You can also append new material to the end of a track. To do this, locate to the end of the track with the Go to End button in the Transport window. From there, simply begin recording and Pro Tools will add the new material to the end of the track. If using Destructive Record mode, the new audio is appended to the audio file and region from the first take. In Nondestructive Record mode, a new file and region are created.

### Recording into a New Playlist

Instead of recording over existing audio regions, there is another way to non-destructively record new takes into the same track. Do this by creating a new playlist for the track, then record just as before.

Tracks can have multiple edit playlists, each of which stores a list of regions strung together in a particular order.

#### To record into a new playlist for a track:

1 From the track's Playlist Selector pop-up, choose New. Enter a name for the new playlist and click OK.



*Playlist Selector*

When a new playlist is created, its name replaces the track name. With this playlist active, names for new audio files and regions are based on its name.

2 Make sure the track is still record-enabled.

3 In the Transport window, click Return to Zero.

4 Click Record in the Transport window. When you are ready to begin recording, click Play.

5 When you have finished recording, click Stop in the Transport window.

An audio file for the new take is written to disk and appears as an audio region in the track's playlist. The new audio region also appears in the Audio Regions List.

6 To audition the new take, click Play in the Transport window.

7 To go back to a previous playlist to compare it to the new take, select the playlist from the track's Playlist Selector.

Selecting a playlist recalls its regions as they previously appeared in the track. At any time, all regions from all playlists are available in the Regions List, and can be mixed and matched between playlists and tracks.

For more information on playlists and playlist editing, see "Playlists" on page 141.

---

## Punch Recording Audio

To replace a portion of a recorded track, you can *punch in* by specifying the record range before recording.

Though there are several ways to set record and play ranges (see “Setting Punch/Loop Points” on page 96), perhaps the easiest is select within the track’s playlist the material to be replaced.

---

▲ To set a record or play range by selecting within a playlist, the Edit and Timeline selections must be linked.

---

You can listen to track material up to and after the punch record range by enabling pre-and post-roll. Listening to pre-roll is helpful in getting the feel for playing in the new material.

During the recording process, playback begins at the pre-roll time (if enabled) and proceeds to the start time (the punch-in point), where recording begin. When the end time (the punch-out point) is reached, Pro Tools automatically switches out of record mode and continues playing through the specified amount of post-roll. This automated punch-in/out feature is a powerful and precise way of re-recording a portion of a track.

---

▲ If you are recording in normal Nondestructive Record mode, punches do not permanently replace the source material. If you actually want to write over the previous data, erasing it forever, use Destructive Record mode.

---

## Monitoring during Punch-Ins

When punch recording, you may want to enable Auto Input Monitoring (by selecting it in the Operations menu). For details, see “Auto Input Monitoring” on page 75.

### To punch record on an audio track:

**1** To record non-destructively, make sure that Operations > Destructive Record is not selected.

If you *do* want to permanently record over the punched record range, select Operations > Destructive Record.

**2** Make sure the track containing the previous take is still record-enabled.

**3** Make sure to select Operations > Link Edit and Timeline Selection.

**4** With the Selector, drag in the track’s playlist until the selection encompasses the desired punch range.

For other methods of setting the record range, see “Setting Punch/Loop Points” on page 96.

**5** To hear existing track material up to the start point, or after the end point, enable and set pre/post-roll times. For details, see “Setting Pre/Post-Roll” on page 97.

**6** Click Record in the Transport window. When you are ready to begin recording, click Play.

If pre-roll is enabled, the track material leading up to the punch-in point plays. You can start playing during the pre-roll to get the “feel.” Material is not recorded until the start point is reached.

When the start point is reached, Pro Tools begins recording. Recording continues until the end point is reached, unless Stop is



clicked in the Transport window. If post-roll is enabled, playback continues for the specified post-roll amount.

If recording non-destructively, a new audio file is written to your hard drive and a new audio region appears in the record track and Audio Regions List.

If recording in Destructive Record mode, the new audio overwrites the previous material in the existing audio file and region.

---

## Loop Recording Audio

Pro Tools provides a loop recording feature that allows you to record take after take while the same section of audio repeats over and over. This is a convenient technique for quickly recording multiple takes of a part without losing spontaneity.

When loop recording, you must first specify the start and end points for the loop. Though there are several ways to set record and play ranges (see “Setting Punch/Loop Points” on page 96), perhaps the easiest is to select within the track’s playlist the material to be looped.

---

▲ To set a record or play range by selecting within a playlist, the Edit and Timeline selections must be linked.

---

The pre-roll setting, if enabled, is used during the first record pass, but on each successive loop, the pre/post-roll times are ignored. To compensate for this, you may want to make the loop range slightly longer. Later, you can trim back the re-

corded takes to the desired length with the Trimmer tool (see “The Trimmer Tool” on page 180).

When loop recording audio, Pro Tools creates a single audio file that comprises all takes. Takes appear as individual regions in the Audio Regions List and are numbered sequentially. Once you stop recording, you can audition any of the recorded takes.

### To loop record an audio track:

**1** Select Operations > Loop Record. When Loop Record mode is enabled, a loop symbol appears in the Record button.



*Loop Recording enabled*

**2** Record enable the audio track by clicking its Record button.

**3** Make sure to select Operations > Link Edit and Timeline Selection.

**4** With the Selector, drag in the track’s playlist until the selection encompasses the desired loop range.

For other methods of setting the record range, see “Setting Punch/Loop Points” on page 96.

**5** To hear track material up to the start point of the loop, enable and set the pre-roll time. For details, see “Setting Pre/Post-Roll” on page 97.

**6** Click Record in the Transport window. When you are ready to begin recording, click Play.

The Record button flashes during the pre-roll. When the start point is reached, Pro Tools begins recording. When the end

point is reached, Pro Tools loops back to the start time and continues playing and recording.

---

\* To cancel all recorded takes while loop recording, press Command+period (Macintosh) or Control+period (Windows).

---

**7** When you have finished recording, click Stop in the Transport window.

If you stop recording before you reach the midpoint of the loop, Pro Tools discards that take. If you record more than half of the looped take, Pro Tools will leave the take in the track when you stop recording.

The recorded takes appear as regions in the Audio Regions List and are numbered sequentially. The most recently recorded take is left in the record track. For details on auditioning the various takes from the Takes List pop-up, see “Auditioning from the Takes List Pop-up Menu” on page 94.

### **Loop Playback and Audio Recording**

When Loop Playback is enabled, Pro Tools will not loop when attempting to record audio tracks with QuickPunch, Destructive Record, or Nondestructive Record mode.

To loop record audio tracks in Pro Tools, you must enable Loop Record mode.

---

## **Auditioning Record Takes**

After recording multiple takes with loop or punch recording, you can replace the take currently residing in the track with previous takes to audition them.

### **To place and audition previous takes:**

- 1** In the Edit window, select the current take with the Grabber.
- 2** Command-drag (Macintosh) or Control-drag (Windows) the take from the Audio Regions List (all takes are numbered sequentially).

The region replaces the previous take and snaps precisely to the correct location.

- 3** Repeat the above steps as desired to audition other takes.

### **Auditioning from the Takes List Pop-up Menu**

Each region resulting from a punch or loop record pass has an identical start time (the *User Time Stamp*). This allows you to easily select and audition takes from the Takes List pop-up menu—even while the session plays or loops.

### **To select a take from the Takes List pop-up:**

- 1** Command-click (Macintosh) or Control-click (Windows) with the Selector at the precise beginning of the loop or punch range.

– or –

If the take currently residing in the track is selected, Command-click (Macintosh) or Control-click (Windows) it with the Selector.

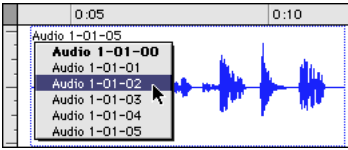

**Takes List pop-up**

A pop-up menu appears containing a list of regions that share the same User Time Stamp.

**2** Choose a region from the Takes List pop-up menu. The region replaces the previous take and snaps precisely to the correct location.

**3** Repeat the above steps as desired to audition other takes.

One way to ensure that future takes have the same *User Time Stamp* (and appear in the Takes List pop-up) is to store punch and loop record selections as Memory Locations. Then if you later need to record additional takes, simply recall the Memory Location. For more information, see “Recalling Punch/Loop Points with Memory Locations” on page 99.

To change the User Time Stamp of other regions so that they appear in the Takes List pop-up for a certain location, use the Time Stamp Selected command in the Regions List pop-up menu. For more information, see “Time Stamping” on page 361.

## **Editing Preferences and Take Regions**

In addition to having the same User Time Stamp, regions that appear in the Takes List pop-up are also restricted according to the following options in the Editing Preferences:

**Take Region Name(s) That Match Track Names** When selected, only regions that share the same root name with the track/playlist appear in the Takes List pop-up menu. For example, the Takes List for a track named “Gtr.L” would show the regions “Gtr.L-01” and “Gtr.L-02-01,” but not “Guit.L-01.”

**Take Region Lengths That Match** When selected, only regions that match the length of the *current selection* (even if it is not an entire region) appear in the Takes List pop-up menu. If there is no selection, all takes with the same User Time Stamp are displayed.

**Separate Region Operates On All Related Takes** When selected, editing a region with the Separate Region command also affects all other related takes with the same User Time Stamp.

This option helps you compare different sections from a group of related takes. For example, you can quickly separate an entire group of related vocal takes into sections, then audition and select the best material from each section independently.

If this option is selected, make sure the “Take Region Names That Match Track Names” and “Take Region Lengths that Match” options are also selected. If they are not, *all* regions in the session that have the same User Time Stamp will be affected.

In most instances, you’ll want to deselect the “Separate Region Operates On All Related Takes” option, to prevent a large number of regions from being created when you use the Separate Region command.

## Setting Punch/Loop Points

The start and end points of a record range for punch and loop recording can be set by the following means:

- Select a range in a track's playlist
- Select a range in a Timebase Ruler
- Drag the Playback Markers in the Ruler
- Enter start and end times in the Transport window
- Recall a Memory Location

### To set the record range with an Edit selection:

- 1 If desired, set the Edit mode to Grid so the selection is constrained to the current Grid value.
- 2 Make sure to select Operations > Link Edit and Timeline Selection.
- 3 With the Selector, drag in a track's playlist until the selection encompasses the desired record range.

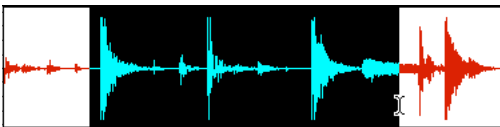

*Playlist selection*

– or –

If a region's start/end points define the record range, click on the region with the Grabber.

### To set the record range with a Timeline selection:

- 1 If desired, set the Edit mode to Grid so the selection is constrained to the current Grid value.
- 2 Drag with the Selector in any Timebase Ruler until the selection encompasses the desired record range.

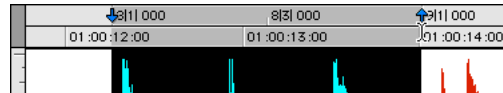

*Timeline selection*

## Playback Markers

When tracks are record-enabled, Playback Markers for start and end times appear as red up/down arrows in the Ruler. If no tracks are record-enabled, the Playback Markers are blue.



*Playback Markers in Ruler*

The Playback Markers can be dragged, either separately or at the same time, to set record and play ranges.

### To set the record range by dragging the Playback Markers:

- 1 If desired, set the Edit mode to Grid so the dragged Playback Markers snap to the current Grid value.
- 2 Drag the first Playback Marker (down arrow) to the start point of the range.

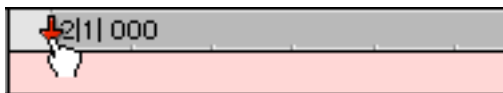

*Dragging a Playback Marker (start time) in Ruler*

**3** Drag the second Playback Marker (up arrow) to the end point of the range.

---

\* If the current record range is already the right length and the range needs only to be moved, Option-drag (Macintosh) or Alt-drag (Windows) either Playback Marker to move both to a new location (while keeping the same length).

---

## Start and End Fields

The Transport window can be resized to display start, end, and length times, and pre- and post-roll settings. When setting a record or play range, it is reflected in these fields.

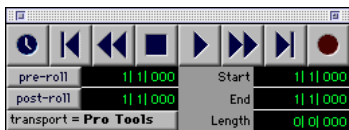

*Transport window with start/end displayed*

You can enter locations in the start and end fields to set the record or play range. The Playback Markers in the Ruler are updated accordingly.

### To set the record range by entering start/end times in the Transport window:

**1** If necessary, resize the Transport window by clicking in the upper right so the start and end times are displayed.

**2** In the Transport window, click in the start field.

– or –

Press Option-slash (Macintosh) or Alt-slash (Windows) to select the start field in the Transport window.

**3** Type in the start location and press slash to enter the value and automatically move to the end field.

**4** Type in the end location and press Enter to accept the value.

---

\* Use the period (.) or Left/Right Arrow keys to move through the different time fields for start/end. Use the Up/Down Arrow keys to increase or decrease the numerical values.

---

## Setting Pre/Post-Roll

Pre- and post-roll times appear as flags in the Ruler. When pre- and post-roll are enabled, the flags are green, otherwise they are gray.



*Green Pre/Post-Roll Flags (enabled) in the Ruler*

Pre- and post-roll amounts can be entered in the Transport window, set from a track's playlist or Timebase Ruler, or by recalling a Memory Location.

---

▲ For TDM systems, recording with pre/post-roll requires two voices for each record-enabled track. In addition, to simultaneously record on 32 tracks with pre/post-roll on a Pro Tools 24 MIX system (which allocates voices to either of two DSP engines, 1–32 and 33–64), the tracks must be evenly distributed between the two DSPs (for instance, tracks 1–16 assigned to voices 1–16 and tracks 17–32 assigned to voices 33–48).

---

## Setting Pre- and Post-Roll in the Transport Window

Pre- and post-roll can be enabled and set from the fields in the Transport window.

### To enable and set the pre- and post-roll times in the Transport window:

- 1 If necessary, resize the Transport window by clicking in the upper right so the start and end times are displayed.
- 2 In the Transport window, click in the pre-roll field.
- 3 Type in the pre-roll amount and press slash to enter the value and automatically move to the post-roll field.
- 4 Type in the post-roll amount and press Enter to accept the new value.
- 5 To enable either pre- or post roll, click the appropriate button so it becomes highlighted.

---

\* Use the period (.) or Left/Right Arrow keys to move through the different time fields for start/end. Use the Up/Down Arrow keys to increase or decrease the numerical values.

---

## Setting Pre- and Post-Roll in a Playlist

You can use the Selector to enable and disable pre- and post-roll by clicking in a track's playlist.

### To enable and set the pre- and post-roll by clicking in a playlist:

- 1 Make sure to select Operations > Link Edit and Timeline Selection.
- 2 With the Selector, drag in the track's playlist until the selection encompasses the desired record range.

- 3 With the Selector, Option-click (Macintosh) or Alt-click (Windows) in the track's playlist before the selection to enable the pre-roll at that location.

- 4 With the Selector, Option-click (Macintosh) or Alt-click (Windows) in the track's playlist after the selection to enable the post-roll at that location.

### To disable the pre- and post-roll by clicking in a playlist:

- 1 With the Selector, Option-click (Macintosh) or Alt-click (Windows) within a track selection near the start to disable the pre-roll.

- 2 With the Selector, Option-click (Macintosh) or Alt-click (Windows) within a track selection near the end to disable the pre-roll.

## Enabling Pre- and Post-Roll from the Operations Menu

Pre- and post-roll (as a pair) can also be enabled and disabled from the Operations menu.

### To enable both pre- and post-roll from the Operations menu:

- Select Operations > Pre/Post Roll Playback.

## Dragging Pre- and Post-Roll Flags in the Ruler

The Pre- and Post-Roll Flags can be dragged in the Ruler, either separately or at the same time, to set their location.

### To set the pre- and post-roll amounts by dragging in the Ruler:

- 1 If desired, set the Edit mode to Grid so the dragged flags snap to the current Grid value.
- 2 Drag the Pre-Roll Flag to the desired location in the Ruler.



Dragging a Pre-Roll Flag in Ruler

- 3 Drag the Post-Roll Flag to the desired location in the Ruler.

\* To set pre- and post-roll values to the same amount, Option-drag (Macintosh) or Alt-drag (Windows) either the Pre- or the Post-Roll Flag in the Ruler.

## Recalling Punch/Loop Points with Memory Locations

Since Memory Locations recall Edit selections, you can use them to recall record and play ranges—that is, as long as the Edit and Timeline selections are linked. Memory Locations can also store and recall pre/post-roll settings.

For more information on Memory Locations, see “Memory Locations and Markers” on page 235.

### To save punch/loop points with a Memory Location:

- 1 Make sure to select Operations > Link Edit and Timeline Selection.
- 2 Set the record range by making a playlist or Ruler selection, or by entering start and end times in the Transport window.

3 If desired, enable and set the pre/post-roll amounts in the Transport window, or by dragging the Pre- and Post-Roll Flags in the Ruler.

4 Press Enter on the numeric keypad.

5 In the New Memory Location dialog, set Time Properties to Selection, and, if desired, under General Properties, select the option for Pre/Post Roll Times.

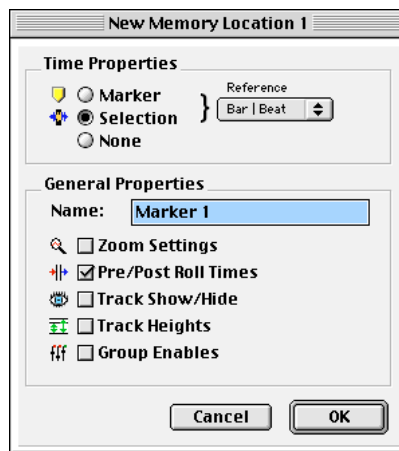

New Memory Location dialog

6 Enter a name for the new Memory Location and click OK to save it.

### To recall punch/loop points with a Memory Location:

- 1 Make sure to select Operations > Link Edit and Timeline Selection.
- 2 Choose Windows > Show Memory Locations.
- 3 In the Memory Locations window, click the name or number of the Memory Location.

The start and end times and pre/post-roll settings stored with the Memory Location are recalled.





# MIDI Recording

Although recording MIDI in Pro Tools is similar to recording audio, there are some important differences.

- ◆ Unlike audio, MIDI recording is almost always destructive. See “The Record Modes and MIDI” on page 82 for details.
- ◆ Unlike audio, a MIDI recording take can be undone after stopping the Transport. For details, see “Undo and MIDI Recording” on page 107.
- ◆ While multiple audio tracks can be record-enabled and simultaneously recorded to, only one MIDI track can be record-enabled at a time. The record-enabled MIDI track can, however, be switched on the fly while recording.
- ◆ It is not necessary to use QuickPunch to punch in on the fly with MIDI tracks. This capability is available in normal Nondestructive Record Mode, and in Destructive Record mode.

---

☞ Refer to the *Pro Tools Hardware Installation Guide* that came with your system for details on configuring it to record MIDI data.

---

---

## MIDI Controller Devices

Pro Tools does not support recording multiple MIDI tracks, nor can it record multiple MIDI channels to a single track. When recording, MIDI received from all devices and all channels is merged to the current record track. MIDI tracks in Pro Tools cannot contain multiple channels and always play back on the track’s assigned device and channels.

The following Pro Tools options determine whether you can record from a MIDI controller device:

- ◆ Devices that are assigned as a MIDI Controller in the Peripherals dialog are ignored when MIDI tracks are recorded. This is to avoid recording data from MIDI control surfaces like the Mackie HUI.
- ◆ On the Macintosh, only devices that are enabled in the Input Devices dialog can be recorded from. For more information, see “Enabling Input Devices” on page 102.

In addition, the following options affect how MIDI data is recorded in Pro Tools.

- ◆ The Input Filter allows you to filter out certain MIDI messages that you may not want to record, such as polyphonic aftertouch or System Exclusive data. For more information, see “MIDI Input Filter” on page 103.
- ◆ Input Quantize, when enabled, automatically quantizes (time corrects) all MIDI notes that are recorded. For more information, see “Input Quantize” on page 104.

---

## Enabling Input Devices

### (Macintosh Only)

To record from a MIDI controller in Pro Tools, the device must be enabled in the Input Devices dialog. You can also use this dialog to make sure unwanted notes from certain devices, such as drum machines or arpeggiators, are not recorded.

---

▲ In order to use control surfaces, like the Mackie HUI, they *must* be enabled in the Input Devices dialog.

---

▲ In order for Pro Tools to sync to MMC, the MMC source must be enabled in the Input Devices dialog.

---

### To enable input devices:

- 1 Choose MIDI > Input Devices.
- 2 In the Input Devices dialog, select the MIDI devices you will record from. Also, make sure any devices that will be used as a control surface are also selected.

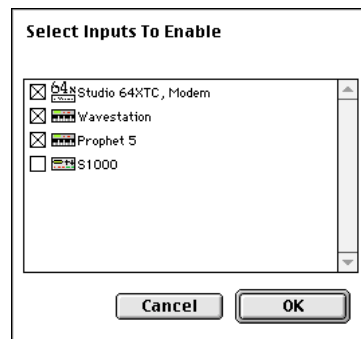

### Input Devices dialog

- 3 Deselect any devices you want to ignore while recording MIDI.
- 4 When you are finished, click OK.

---

## MIDI Thru

To monitor MIDI tracks while recording, enable MIDI Thru. When enabled, Pro Tools routes MIDI from your controllers to the device and channels assigned to the MIDI track currently record-enabled.

### To enable MIDI Thru:

- Select MIDI > MIDI Thru.

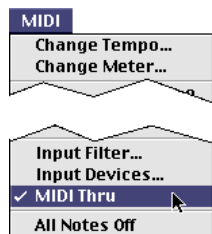

### MIDI Thru enabled

When using MIDI Thru, you should disable Local Control on your MIDI keyboard controller. Otherwise, your keyboard may receive double MIDI notes, which can lead to stuck notes. If unsure how to disable Local Control for your instrument, refer to the manufacturer's documentation.

- ▲ When MIDI Thru is enabled, System Exclusive events are echoed to the MIDI device assigned to the record-enabled track—but only if the sysex events are smaller than 256 bytes.

---

## MIDI Input Filter

Use the MIDI Input Filter to filter out certain MIDI messages from your recordings. The Input Filter can be set to record “all” messages, “only” the specified messages, or “all except” the specified messages.

### For instance, to filter out polyphonic aftertouch and System Exclusive data:

- 1 Choose MIDI > Input Filter.
- 2 In the MIDI Input Filter dialog, select the Only option.

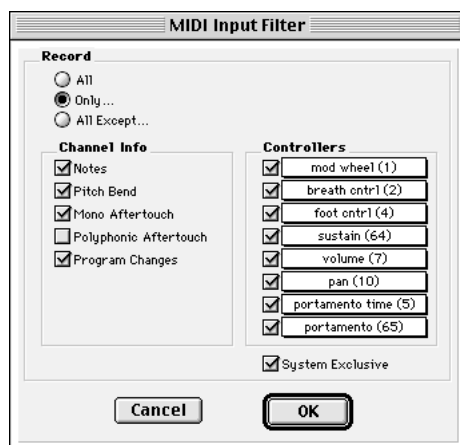

### MIDI Input Filter

- 3 Make sure the options for Polyphonic Aftertouch and System Exclusive are not selected. Leave all other messages selected.
- 4 Click OK.

When using the Only option, only the MIDI messages that are selected will be recorded. Conversely, when using the All Except option, the selected messages will not be recorded.

---

## Input Quantize

When Input Quantize is enabled, all recorded MIDI notes are quantized automatically. To preserve the original “feel” of your recorded MIDI tracks, make sure to disable this option.

### To enable Input Quantize:

- 1 Choose MIDI > Input Quantize.
- 2 In the Input Quantize window, select the Enable Input Quantize option.

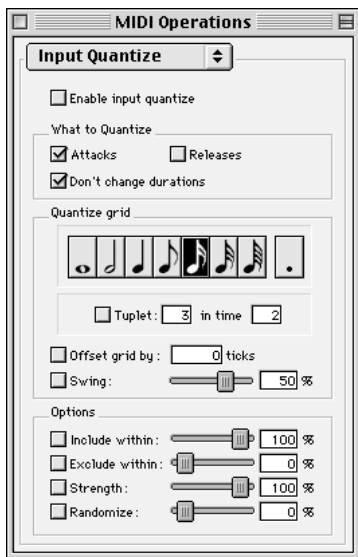

**Input Quantize window**

Configure the other options in the Input Quantize window as desired. For details on the various Quantize options, see “Quantize” on page 214. When finished, close the Input Quantize window.

For *drum machine* style loop recording, use Input Quantize while loop recording MIDI in Merge mode (see “Loop Recording with Merge Mode” on page 109).

---

## Wait for Note

The Wait for Note button, located in the Transport window, determines how Pro Tools begins recording. When enabled, Pro Tools will not begin recording until a MIDI event is received. This ensures that you begin recording when you’re ready to play, and that the first note, or other MIDI data, is recorded precisely at the beginning of the record range (start time).

Wait for Note can be used when recording normally, when punching in, or when loop recording. If pre-roll is enabled, it occurs after the MIDI event is received and before recording begins.

### To enable Wait for Note:

- 1 To view the MIDI controls in the Transport window, select Display > Transport Window Shows > MIDI Controls.

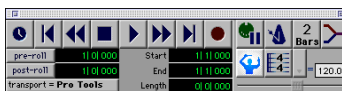

**Transport window with MIDI Controls**

- 2 In the Transport window, click the Wait for Note button so it becomes highlighted.

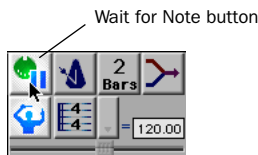

**Wait for Note enabled**

---

\* With the Operation Preference for “Use F11 for Wait for Note” is enabled, you can press F11 to turn on Wait for Note.

---

## MIDI Merge/Replace

The MIDI Merge button, located in the Transport window, determines how MIDI is recorded when overdubbing or punching in. When MIDI Merge is on (*Merge mode*), recorded MIDI is merged with existing track material. When MIDI Merge is off (*Replace mode*), existing data within the punched region is replaced by the newly recorded material.

The MIDI Merge button can be turned on and off while playing or recording. In Loop Record mode, MIDI Merge has no effect, so its button is dimmed.

### To enable MIDI Merge:

- 1 To view the MIDI controls in the Transport window, select **Display > Transport Window Shows > MIDI Controls**.

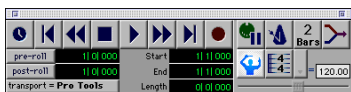

*Transport Window with MIDI Controls*

- 2 In the Transport window, click the MIDI Merge button so it becomes highlighted.

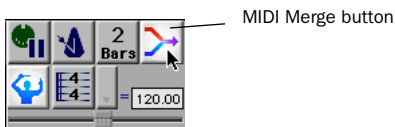

*MIDI Merge enabled*

## Recording a MIDI Track

To record MIDI in Pro Tools, first add a new MIDI track and record enable it.

\* To take advantage of the editing capabilities in Pro Tools, make sure to record with the click enabled. This ensures that recorded data aligns with the session's bar/beat boundaries.

### To configure a new MIDI track for recording:

- 1 Choose **File > New Track** and specify 1 MIDI Track, then click **Create**.

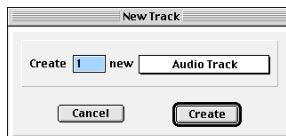

*New Track dialog*

\* To auto-scroll the Track Type pop-up in the New Track dialog, press **Command** (Macintosh) or **Control** (Windows) and use the **Up/Down Arrow** keys.

- 2 Rename the new track as desired. Track names are used to auto-name recorded audio files and regions. For more information, see "Track Names" on page 78.

- 3 In the Mix window, click on the track's MIDI Device/Channel Selector and assign a device and channel from the pop-up menu. Channels already assigned to another track appear bold in this menu.

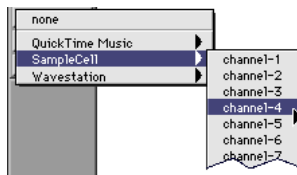

*MIDI Device/Channel Selector*

---

\* To assign multiple destinations to a single MIDI track, Shift-click the MIDI Device/Channel Selector and select additional channels from any device.

---

**4** If desired, assign a default program change to the track. In the Mix window, click on the Program button (Prog) and make the necessary selections for program and bank select, then click Done.

Default program changes are sent whenever the track is played. For more information, see “Program Changes” on page 208.

**5** In the Mix Window, click the MIDI track’s Record button to record enable the track.

#### **To record to the new MIDI track:**

**1** Put Pro Tools in normal Nondestructive Record mode. In the Operations menu, de-select Destructive Record, Loop Record, and QuickPunch.

**2** If desired, enable and configure the click, and set a default tempo and meter for the session. For details, see “Recording with the Click” on page 83.

**3** If desired, enable Wait for Note or Countoff In the Transport window.

**4** Make sure MIDI > MIDI Thru is selected, then play some notes on your MIDI controller. The MIDI instrument assigned to the track should sound, and the track’s meters should register MIDI activity.

**5** In the Transport window, click Return to Zero so the start/end times are cleared. This ensures that you’ll start recording from the beginning of the track.

**6** Click Record in the Transport window.



#### **Record button**

◆ If using Wait for Note, the Play, Record, and Wait for Note buttons flash. Recording begins when a MIDI event is received.

◆ If using Countoff, click Play to start counting down. The Record and Play buttons flash during the countoff, after which recording begins.

**7** When you have finished recording, click Stop in the Transport window.

The newly recorded MIDI data appears as a MIDI region in the track’s playlist, and in the MIDI Regions List.

---

☞ There are several keyboard shortcuts you can use to begin recording. See “Record Shortcuts” on page 88 for details.

---

#### **To play back the recorded MIDI track:**

**1** Click the Record button for the MIDI track to take it out of record-enabled mode.

**2** In the Transport window, click Return to Zero.

**3** Click Play in the Transport window to begin playback.

The recorded MIDI data plays back through the track’s assigned instrument and channel.

## Undo and MIDI Recording

After recording a MIDI track and the Transport is stopped, you can undo the previous record take.

### To undo a MIDI recording:

- Once the Transport has been stopped, choose Edit > Undo MIDI Recording.

The track's playlist is restored to its previous state. However:

- ◆ If you punched in and out several times before stopping the Transport, only the last punch is undone.
- ◆ If you switched the MIDI record track during the record pass, only the last MIDI track recorded to is undone.
- ◆ When using Loop Record mode, all takes from each record pass are discarded.

## Canceling a Record Take

It is also possible to discard the current record take *before* the Transport is stopped.

### To cancel a record take while recording:

- Press Command+period (Macintosh) or Control-period (Windows) before the Transport is stopped.

If using Loop Record mode, all takes from each record pass are discarded.

---

## Punch Recording MIDI

To replace a portion of a MIDI track, you can *punch in* by specifying the record range before recording.

### To punch in on a MIDI track:

- 1 Put Pro Tools in normal Nondestructive Record mode. In the Operations menu, deselect Destructive Record, Loop Record, and QuickPunch.
- 2 If desired, enable and configure the click. For details, see "Recording with the Click" on page 83.
- 3 In the Transport window, disable Wait for Note and Countoff.
- 4 Make sure the track containing the previous take is record-enabled.
- 5 Make sure to select Operations > Link Edit and Timeline Selection.
- 6 With the Selector, drag in the track's playlist until the selection encompasses the desired punch range.

For other methods of setting the record range, see "Setting Punch/Loop Points" on page 96.

- 7 To hear existing track material up to the start point, or after the end point, enable and set pre/post-roll times. For details, see "Setting Pre/Post-Roll" on page 97.
- 8 To replace existing track material, disable MIDI Merge in the Transport window.
- 9 Click Record in the Transport window. When you are ready to begin recording, click Play.

If pre-roll is enabled, the track material leading up to the punch-in point plays. You can start playing during the pre-roll to get the “feel.” Material is not recorded until the start point is reached.

When the start point is reached, Pro Tools begins recording. Recording continues until the end point is reached, unless Stop is clicked in the Transport window. If post-roll is enabled, playback continues for the specified post-roll amount.

### Punching “on the fly” with MIDI

You don’t have to set a record range to punch in on a MIDI track. In fact, you can punch in and out freely at any time during playback. Unlike audio tracks, it is not necessary to enable QuickPunch to perform real-time punches.

---

\* For Digi 001 systems, you can use a footswitch (connected to the I/O box) to punch in and out when recording MIDI.

---

#### To punch on the fly with MIDI:

- 1 Put Pro Tools in normal Nondestructive Record mode. In the Operations menu, deselect Destructive Record, Loop Record, and QuickPunch.
- 2 Record enable the track by clicking its Record button.
- 3 To replace existing track material, disable MIDI Merge in the Transport window.
- 4 In the Transport window, click Return to Zero.
- 5 Start playback by clicking Play in the Transport window.

6 When you reach the punch-in point, click Record in the Transport window.

– or –

For Digi 001 systems with a connected footswitch, press the footswitch at the punch-in point.

The Record button stops flashing and stays lit during recording.

7 To punch out, click Record again (or press the footswitch).

Pro Tools exits record mode and continues playing. You can perform additional punches during the same pass.

### Regions and Punch Recording

Depending on the record range, new regions may be created after punch recording. For instance, Figure 3 shows two existing regions before recording. Since the start and end times occur within both of the existing regions, a new region is created to fill the space between them.

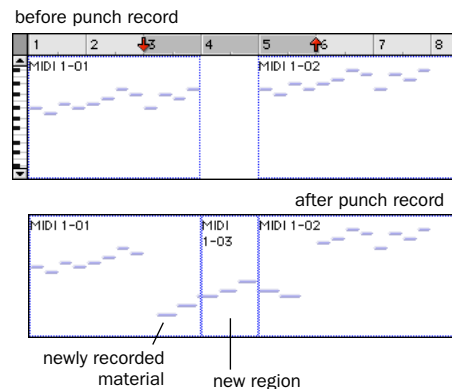

Figure 3. Region added after punch record



However, when selecting an entire region, or a section within a region, before punching-in, no new regions are created. In this instance, only the material residing within the existing region changes, with no new material recorded outside the region.

Unlike audio recording, MIDI recording in this scenario is destructive. If a region is altered because of a record take, the original material is lost (unless you choose Edit > Undo MIDI Recording). If an existing region contains important material, always make a backup before recording over it.

---

## Loop Recording MIDI

Loop recording with MIDI is supported by two methods:

- In normal Nondestructive Record mode, enable Loop Playback and MIDI Merge for drum machine style loop recording.  
– or –
- Use Loop Record mode to record multiple takes on each record pass. This is similar to loop recording audio.

## Loop Recording with Merge Mode

For drum machine style loop recording, use normal Nondestructive Record mode with Loop Playback and MIDI Merge enabled. With this method, MIDI is recorded and merged to the same region with each new record pass—thereby allowing you to, for instance, record hi-hats on the first pass and kick and snare on the next.

Make sure that MIDI Merge is enabled in the Transport window, otherwise (in Replace mode) each subsequent take will destructively replace the previous.

---

\* You can record enable a different MIDI track on the fly while loop recording. While pressing Command (Macintosh) or Control (Windows), use the Up/Down Arrows to record enable the previous or next MIDI track.

---

### To loop record with MIDI Merge:

- 1 Put Pro Tools in normal Nondestructive Record mode. In the Operations menu, deselect Destructive Record, Loop Record, and QuickPunch.
- 2 Select Operations > Loop Playback. When Loop Playback is enabled, a loop symbol appears in the Play button.



*Loop Playback enabled*

- 1 Choose File > New Track and specify 1 MIDI Track, then click Create.
- 2 Record enable the new MIDI track by clicking its Record button.
- 3 Make sure no audio tracks are record-enabled.
- 4 In the Transport window, click the MIDI Merge button so it becomes highlighted.

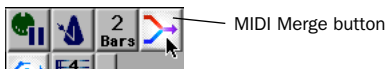

*MIDI Merge enabled*

- 5 If desired, enable Input Quantize to automatically quantize recorded material (see “Input Quantize” on page 104).

**6** Make sure to select Operations > Link Edit and Timeline Selection.

**7** With the Selector, drag in the track's playlist until the selection encompasses the desired loop range.

For other methods of setting the record range, see "Setting Punch/Loop Points" on page 96.

**8** To hear track material up to the start point of the loop, enable and set the pre-roll time. For details, see "Setting Pre/Post-Roll" on page 97.

**9** Click Record in the Transport window. When you are ready to begin recording, click Play.

The Record button flashes during the pre-roll. When the start point is reached, Pro Tools begins recording. When the end point is reached, Pro Tools loops back to the start point and continues playing and recording.

**10** Play some notes on your MIDI controller. Newly recorded MIDI data appears as a region in the record track. On each successive take, recorded material shows up in the region, without replacing material from previous takes.

**11** If desired, switch to a new record track. While pressing Command (Macintosh) or Control (Windows), use the Up/Down Arrows to record enable the previous or next MIDI track.

**12** When you have finished recording, click Stop in the Transport window.

The newly recorded MIDI data appears as a MIDI region in the track's playlist, and in the MIDI Regions List.

## Loop Recording Multiple Takes

When recording MIDI in Loop Record mode, new regions are created each time new material is received during a record pass. This differs somewhat from loop recording audio, where separate audio files and regions are created with *each* subsequent record pass.

You can use this method of MIDI loop recording to record successive takes without stopping the record process, thereby preserving your creative spontaneity. Another advantage with this method of recording MIDI, which is nondestructive, is that existing and newly recorded regions remain intact (and available in the MIDI Regions List).

### To record MIDI in Loop Record mode:

**1** Select Operations > Loop Record. When Loop Record mode is enabled, a loop symbol appears in the Record button.



*Loop Recording enabled*

**1** Choose File > New Track and specify 1 MIDI Track, then click Create.

**2** Record enable the new MIDI track by clicking its Record button.

**3** Make sure no audio tracks are record-enabled.

**4** Make sure to select Operations > Link Edit and Timeline Selection.

**5** With the Selector, drag in the track's playlist until the selection encompasses the desired loop range.

For other methods of setting the record range, see “Setting Punch/Loop Points” on page 96.

**6** To hear track material up to the start point of the loop, enable and set the pre-roll time. For details, see “Setting Pre/Post-Roll” on page 97.

**7** Click Record in the Transport window. When you are ready to begin recording, click Play.

The Record button flashes during the pre-roll. When the start point is reached, Pro Tools begins recording. When the end point is reached, Pro Tools loops back to the start point and continues playing and recording.

**8** Play some notes on your MIDI controller. A new MIDI region containing the newly recorded material is automatically created and appears in the track’s playlist, replacing the previous region.

Regions are replaced (non-destructively) during subsequent record passes when new MIDI material is received.

**9** When you have finished recording, click Stop in the Transport window. The most recently recorded take is left in the record track.

The recorded takes appear as regions in the MIDI Regions List and are numbered sequentially. The takes, which are the same length and easily interchangeable, can be auditioned from the Takes List pop-up menu—even while the session plays or loops.

### To audition the various record takes:

**1** Command-click (Macintosh) or Control-click (Windows) with the Selector at the precise beginning of the loop record range.  
– or –

If the take currently residing in the track is selected, Command-click (Macintosh) or Control-click (Windows) it with the Selector.

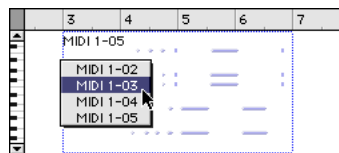

*Auditioning loop record takes*

A pop-up menu appears containing a list of regions that share the same User Time Stamp.

**2** Choose a region from the Takes List pop-up menu. The region replaces the previous take and snaps precisely to the correct location.

For more information on auditioning and managing takes, see “Auditioning Record Takes” on page 94.

---

## Recording System Exclusive Data

Pro Tools supports recording and playing System Exclusive data (sysex) with MIDI tracks. This allows you to use MIDI tracks in Pro Tools to store patch and configuration data for your MIDI devices, or to record real-time sysex changes for a particular synth parameter (filter cutoff, for instance).

### To record a sysex dump at the beginning of a MIDI track:

- 1 Make sure that the MIDI OUT for the device sending the sysex is connected to your MIDI interface's MIDI IN.
- 2 Put Pro Tools in normal Nondestructive Record mode. In the Operations menu, deselect Destructive Record, Loop Record, and QuickPunch.
- 3 In the MIDI Input Filter, enable recording of System Exclusive data.
  - 1 Choose File > New Track and specify 1 MIDI Track, then click Create.
  - 2 Record enable the new MIDI track by clicking its Record button.
  - 3 Enable Wait for Note in the Transport window.
  - 4 In the Transport window, click Return to Zero so the start/end times are cleared. This ensures that you'll start recording from the beginning of the track.
  - 5 When you are ready to begin recording, click Record in the Transport window.

The Record, Play, and Wait for Note buttons flash, indicating that Pro Tools is waiting for MIDI data.

6 Initiate the sysex transfer from the MIDI device. When receiving the MIDI data, Pro Tools automatically begins recording.

7 When the transfer is complete, click Stop in the Transport window.

The newly recorded MIDI data appears as a MIDI region in the track's playlist, and in the MIDI Regions List. MIDI regions that contain System Exclusive data appear blank when the track's Display Format is set to Regions.

To see the sysex event blocks, which indicate the location of the data, set the track to display Sys Ex. For details on moving and copying of sysex data, see "System Exclusive Events" on page 211.

### To resend the sysex from Pro Tools:

- 1 For the device receiving the System Exclusive data, make sure its MIDI IN is connected to your MIDI interface's MIDI OUT. Also, make sure the device is set to receive sysex. Some devices require that memory protect be off.
- 2 For the previously recorded track, click its Record button to take it out of record-enabled mode.
- 3 In the Mix window, click on the track's MIDI Device/Channel Selector and assign the device from the pop-up menu.
- 4 In the Transport window, click Return to Zero.
- 5 Click Play in the Transport window to begin playback. Pro Tools begins playing and transmits the previously recorded sysex to the assigned MIDI device.

# Advanced Recording

## Using QuickPunch

Pro Tools features an intelligent on-the-fly punch capability called QuickPunch. QuickPunch lets you instantaneously punch in and out on record-enabled audio tracks during playback by merely clicking the Record button in the Transport window.

\* For Digi 001 systems, you can use a foot-switch (connected to the I/O box) to punch in and out when recording with QuickPunch.

When using QuickPunch, Pro Tools starts recording a new audio file when you begin playback, automatically defining and naming regions in that file at each punch in/out point. Up to 100 of these “running punches” can be performed during a single pass. Unlike normal punch recording (see “Punch Recording Audio” on page 92), QuickPunch provides instantaneous monitor switching on punch-out. All QuickPunch recording is nondestructive.

\* You don’t need to use QuickPunch to punch on the fly with MIDI tracks. This capability is available in normal Nondestructive Record mode, and in Destructive Record mode.

## QuickPunch Crossfade Length

Pro Tools can automatically write a crossfade for each punch point when using QuickPunch. The length for these crossfades is set with the QuickPunch Crossfade Length option in the Editing Preferences.

### To set the QuickPunch Crossfade Length:

- 1 Choose **Setup > Preferences** and click **Editing**.
- 2 Enter a value (in msec) for the **QuickPunch Crossfade Length**.

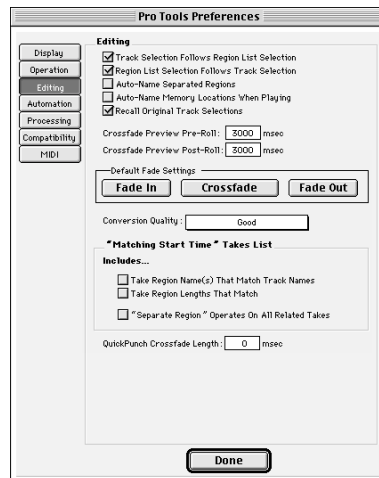

Editing Preferences

A good general-purpose crossfade length for punches is 4 milliseconds. If you set the preference to zero, Pro Tools will not create any crossfades at the punch-in/out points.

**3** Click Done.

If a value other than zero is specified for the QuickPunch Crossfade Length, QuickPunch writes a pre-crossfade at the punch-in point (which occurs up to but not into the punched region boundary), and a post-crossfade at the punch-out point (which occurs after the punched region).

Even if the QuickPunch Crossfade Length is set to zero, Pro Tools always executes a 4 millisecond “monitor only” crossfade (which is not written to disk) to avoid distracting pops or clicks that might occur as you enter and exit record mode.

---

☞ QuickPunch crossfades can later be edited in the same manner as standard crossfades. For details, see “Using Crossfades” on page 245.

---

## **QuickPunch Guidelines for TDM Systems**

When using QuickPunch on TDM systems, two voices are required for each record-enabled track. For instance, a Pro Tools 24 system with 32 voices can simultaneously record on up to 16 tracks with QuickPunch.

If the required number of voices for the record-enabled tracks is not available when switching to QuickPunch mode, you’ll be prompted to free up the necessary voices.

### **To free up voices on tracks that are not record-enabled:**

- Set the voice assignment for the track to Off.
  - or –
- With Mute Frees Voices enabled in the Operations menu, mute the track.

---

▲ The Mute Frees Voices option can cause Mute lag time and slower monitor switching when punching. For details, see “Mute Frees Voice and Mute Lag Time” on page 60.

---

▲ When using a 64 voice system, such as the Pro Tools 24 MIX system, voices are allocated to either of two DSP engines (1–32 and 33–64). Therefore, if you want to use QuickPunch on 32 tracks, these tracks must be evenly distributed between the two DSPs (for instance, tracks 1–16 assigned to voices 1–16 and tracks 17–32 assigned to voices 33–48).

---

As necessary, voices in use by other tracks, which are not record-enabled, may be stolen while recording with QuickPunch.

## QuickPunch Guidelines for Pro Tools LE

### Digi 001 and Audiomedia III

For non-TDM systems, the maximum number of tracks that can be simultaneously recorded with QuickPunch in a session with 24 audio tracks is 8.

To simultaneously record more tracks than this with QuickPunch, you'll need to reduce the number of tracks in the session. For instance, a session with 20 audio tracks can record 10 tracks with QuickPunch, and a session with 16 audio tracks can record 12.

---

▲ With Pro Tools LE, QuickPunch uses CPU processing power, and may reduce the number of tracks and Plug-Ins you can use.

---

#### To punch on the fly with QuickPunch:

**1** Select Operations > QuickPunch. When QuickPunch is enabled, a “P” appears in the Record button.



*QuickPunch enabled*

**2** If desired, configure the QuickPunch Crossfade Length option in the Editing Preferences (see “QuickPunch Crossfade Length” on page 113).

**3** Record enable the tracks you want to punch in on. Make sure there are enough available voices on your system.

- For TDM systems, see “QuickPunch Guidelines for TDM Systems” on page 114.
- For non-TDM systems, see “QuickPunch Guidelines for Pro Tools LE” on page 115.

**4** Prepare to record by cueing Pro Tools to an appropriate location (if desired, enable a pre-roll value in the Transport window).

**5** Start playback by clicking Play in the Transport window.

**6** When you reach the punch-in point, click Record in the Transport window.  
– or –

For Digi 001 systems with a connected footswitch, press the footswitch at the punch-in point.

The Record button stops flashing and stays lit during recording.

**7** To punch out, click Record again (or press the footswitch).

As Pro Tools continues playing, you can perform additional punches (up to 100). When recording multiple punches during a single pass, a single audio file is recorded from which Pro Tools creates the appropriate regions.

## **QuickPunch with an Edit Selection**

If you make an Edit selection and use QuickPunch, the following rules apply:

If you are not online, recording begins and stops whenever you click the Record button—regardless of the selection’s start or end point.

If you are online, punch-in/out behavior is controlled by the Online Options setting in the Operations Preferences. If you select Record Online at Insertion/Selection, QuickPunch punches in/out only within the selection (or in the case of an insertion point, only after the insertion point). If you select Record Online at Time Code Lock, QuickPunch disregards the selection and punches in/out whenever you want (after Pro Tools has locked to time code).

## **Region and Take Numbering with QuickPunch**

After recording with QuickPunch, the new audio regions appear in the Audio Regions List. This includes the whole-file audio region encompassing all punches from the record pass, along with the regions derived for each punch.

Names for the parent audio files end with “00” and the punch regions are numbered consecutively starting with “01.” For instance, if QuickPunch is used to punch in twice on a track called “Lead Gtr,” a region for the parent audio file appears and is named “Lead Gtr-01-00,” and two regions for the punches appear that are named “Lead Gtr-01-01” and “Lead Gtr-01-02.”

If you stop playback and record additional punches with QuickPunch, subsequent regions are named by incrementing the first two digits in the name. For instance, on the second pass, regions would appear named as “Lead Gtr-02-00,” “Lead Gtr-02-01,” and so forth.

---

## **Recording from a Digital Source**

If you plan to use a DAT recorder or digital-output CD player with your Pro Tools system, make sure it supports the correct digital format. AES/EBU inputs and outputs should only be connected to other AES/EBU-equipped devices, and S/PDIF inputs and outputs should only be connected to other S/PDIF-equipped devices.

On the 888/24 I/O and ADAT Bridge I/O, both AES/EBU and S/PDIF outputs are active at all times, so you can actually send digital audio to two different digital devices simultaneously at mix time. However, Pro Tools can only receive digital audio from one digital source (AES or S/PDIF) at a time.

In addition, although the 888/24 I/O has four stereo AES input pairs, only input pair 1–2 on the master audio interface, (the first audio interface connected to your main DSP card), can accept an external digital clock source.



### To record from a DAT recorder with Pro Tools:

- 1 Connect the digital output of the DAT recorder to the appropriate digital input of your audio hardware.
- 2 Choose Windows > Show Session Setup. From the Sample Rate pop-up menu, choose the desired sample rate.

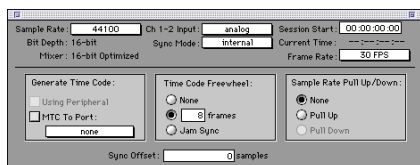

#### Session Setup window

- 3 Choose Setups > Hardware. From the Ch 1–2 Input pop-up menu, select the appropriate input source.

If your audio hardware supports both AES/EBU and S/PDIF, select the format you will use from the Digital Format pop-up.

- 4 Click OK to close the Hardware Setup dialog.
- 5 Choose File > New Track and specify 2 Audio Tracks, then click Create.
- 6 In the Mix window, record enable the new audio tracks by clicking their Record buttons.
- 7 Assign the Input Selectors for the tracks to Ch 1–2 Inputs. Since this is a digital-domain transfer, you don't need to worry about input levels.
- 8 Set the pan controls for the tracks to 100% right and 100% left, respectively, to allow stereo monitoring during playback.

9 Put Pro Tools in normal Nondestructive Record mode. In the Operations menu, deselect Destructive Record, Loop Record, and QuickPunch.

10 In the Transport window, click Return to Zero so the start/end times are cleared. This ensures that you'll start recording from the beginning of the track.

11 Click Record in the Transport window. When you are ready to begin recording, click Play.

12 Initiate playback on the DAT recorder.

13 When the material from the DAT recorder has finished, click Stop in the Transport window.

### After a Digital Transfer

After you have finished recording digitally, set the Sync Mode pop-up menu in the Session Setup window back to Internal. Otherwise, Pro Tools will not switch back to its own internal clock and will not record or play audio properly. Failure to switch back to Internal sync typically results in pitch problems (fast or slow playback) or DAE errors, since a DAT recorder or CD Recorder that is idle can default to a different sample rate or stop outputting a sample rate clock altogether.

---

## Half-Speed Recording and Playback

Pro Tools lets you play and record at half-speed. This capability is similar to that of a tape deck where you can record material at half-speed and then play it back at normal speed (up an octave) for special effects.

### To record at half-speed:

- 1** Press Command+Shift+Spacebar (Macintosh) or Control+Shift+Spacebar (Windows). Recording begins and all existing track material plays at half-speed.
- 2** When you have finished recording, click Stop.

When played at normal speed, the material recorded at half-speed plays twice as fast (up an octave).

---

\* Use half-speed recording to record difficult to play MIDI tracks. This allows you to hear audio tracks while recording. Half-speed recording and playback do not affect how MIDI tracks sound when played.

---

### To play at half-speed

- 1** Press Shift+Spacebar. Playback begins and track material plays at half-speed. If any tracks were recorded at half-speed, they play at normal speed.
- 2** Click Stop in the Transport window to stop playback.

---

\* Use half-speed playback to learn or transcribe difficult passages in recorded tracks.

---

# Importing/Exporting Audio and MIDI

---

## Importing Audio

In Pro Tools you can import previously recorded audio files and regions from other sessions. In addition, you can convert and import audio files that don't match the session's supported file type, bit depth, or sample rate.

Audio files and regions can be imported onto a new track, or they can be imported into the Regions List, where they can be dragged to existing tracks.

Supported audio formats include:

- WAV
- Sound Designer II
- AIFF
- snd Resource (Macintosh only)

If region definitions are present in an audio file, you can convert and import selected regions without importing the entire parent audio file.

Supported files, and regions, can also be auditioned before importing.

---

## Importing Audio into a Session (Macintosh)

When importing into a Macintosh session, choose File > Import Audio/Track to place the audio into a new track. To import into the Audio Regions List, choose Import Audio from the Audio Regions pop-up menu. Both commands call up the same Import Audio dialog (see Figure 4 on page 120).

---

▲ For Pro Tools III systems, the Import Audio dialog only recognizes hard drives that are connected to the Disk I/O card. To import audio from hard drives connected to the SCSI bus, or from networked volumes, use the Convert & Import command (see "Convert and Import Audio Command" on page 121 for details).

---

Files imported with either of these commands must be Sound Designer II or AIFF format, and must also match the session's bit depth. If you import an audio file with a sample rate that doesn't match the current session's sample rate, the file will not play back at the original pitch.

▲ Pro Tools does not store waveform overview data with AIFF files, so it must be recalculated every time the session is opened. To avoid this, convert AIFF files to SDII format (see “Convert and Import Audio Command” on page 121 for details).

To import files in other formats or bit depths, or to work with a copy of the source file, use the Import & Convert command in the Audio Regions List pop-up menu. For details, see “Convert and Import Audio Command” on page 121.

### To import an audio file or region into a new track:

1 Choose File > Import Audio/Track.

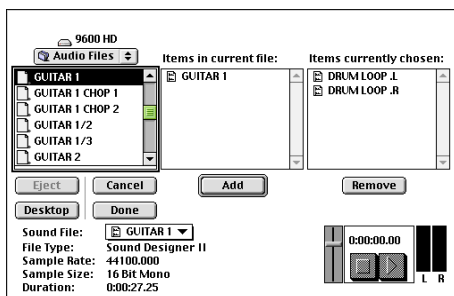

Figure 4. Import Audio dialog (Macintosh)

2 In the Import Audio dialog, locate the audio files you want to import.

All Sound Designer II and AIFF files for the current folder are displayed in the file list on the left. Click on a file to view its attributes in the lower left.

The center list displays the regions associated with the currently selected audio file. One region name reflects the original audio

file, or the “whole-file region.” Importing this region loads the entire source file into the session.

3 To audition a selected file or region before you import it, use the Play and Stop buttons.

Adjust playback volume with the vertical slider. To navigate to a particular location in the file, click in the counter display. Clicking left moves toward the beginning, clicking right moves toward the end.

4 To place a file or region in the import list on the right, select it and click Add, or double-click the file or region.

In the import list, audio files are distinguished from regions by their icons.



Icons for audio files (left) and regions (right)

5 To remove a file or region from the import list on the right, select it and click Remove, or double-click the file or region.

6 Once the audio files and regions have been added to the import list, click Done.

Each of the files and regions from the import list are imported into their own audio track, and also appear as regions in the Audio Regions List.

If you import stereo interleaved files, they are imported as separate mono (L and R) files and saved to the session’s “Audio Files” folder.

## To import audio into the Audio Regions List:

1 Choose Import Audio from the Audio Regions List pop-up menu.

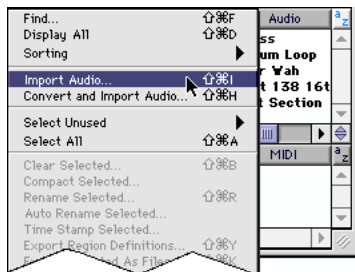

*Import Audio command (Macintosh)*

2 In the Import Audio dialog (see Figure 4), locate the audio files you want to import.

Sound Designer II and AIFF files for the current folder are displayed in the file list on the left.

3 Select audio files from the file list on the left and click Add to place them in the import list on the right.

4 Select regions from the regions list in the center and click Add to place them in the import list. Regions for the currently selected audio file (on the left) are displayed in the center.

5 To remove a file or region from the import list on the right, select it and click Remove, or double-click the file or region.

6 Once the audio files and regions have been added to the import list, click Done.

Each of the files and regions from the import list are imported and appear in the Audio Regions List. Interleaved stereo files are imported and saved as two mono files.

## Convert and Import Audio Command (Macintosh)

To import audio files that don't match the session's file type, bit depth, or sample rate, use the Convert and Import Audio command. This command is also useful if you want to work with a copy of an audio file or region.

Supported file types that can be converted include: WAV, AIFF, Sound Designer II, and snd (Macintosh system sound resource). In addition, stereo interleaved files can be converted to separate left and right mono files.

The quality of sample rate conversion used by Pro Tools is determined by the Preference for Conversion Quality. For details, see "Conversion Quality" on page 126.

---

\* For Pro Tools III systems, you can use the Convert and Import Audio command to audition, convert, and import files on hard drives that are not attached to the Disk I/O card.

---

## To convert and import audio into a session:

1 Choose Convert and Import Audio from the Audio Regions List pop-up menu.

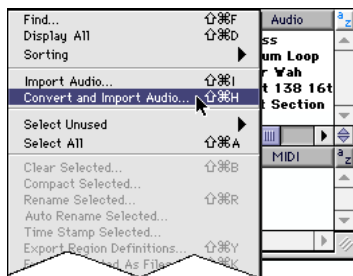

*Convert and Import Audio command (Macintosh)*

**2** In the Convert and Import Audio dialog, locate the audio files you want to import.

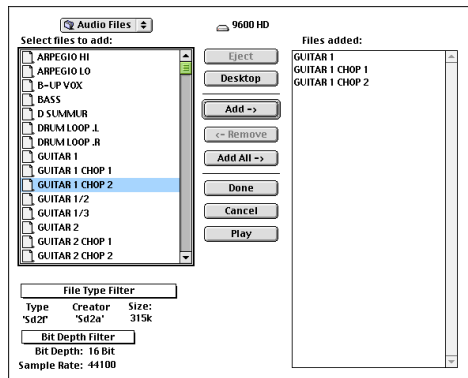

*Convert and Import Audio dialog (Macintosh)*

- 3** Select the file types and bit depths you want to view from the pop-up menus for File Type Filter and Bit Depth Filter.
- 4** Select a file to view its attributes in the lower left. Click Play to audition the file.
- 5** Select audio files from the file list on the left and click Add to place them in the import list (on the right), or click Add All to add all files currently displayed.
- 6** To remove a file from the import list, select it and click Remove.
- 7** Once the audio files have been added to the import list, click Done.

Specify a destination for the new files. For Pro Tools III systems, you must save the files to a hard drive connected to the Disk I/O card.

Each of the files from the import list are converted to the session's sample rate and bit depth and appear in the Audio Regions List.

---

## Importing Audio into a Session (Windows)

When importing into a Windows session, choose File > Import Audio/Track to place the audio into a new track. To import into the Audio Regions List, choose Import and Convert Audio from the Audio Regions List pop-up menu. Both commands call up the same Convert & Import Audio dialog (see Figure 5 on page 123).

With Pro Tools for Windows, you can work with either Windows or Macintosh session formats. The session format determines not only the recorded file types, but the file types that can be imported (WAV for Windows, and Sound Designer II for Macintosh). Audio files that don't match the type supported for the current session must be converted before importing.

---

☞ The quality of sample rate conversion used by Pro Tools is determined by the Preference for Conversion Quality. For details, see "Conversion Quality" on page 126.

---

### To import an audio file or region into a new track:

- 1** Choose File > Import Audio/Track.
- 2** In the lower left of the Convert & Import dialog, choose a file type to display. If importing Macintosh files that do not have file name extensions, select All Files.
- 3** Using the toolbar or Folders menu, locate the audio files you want to import.

All files in the current folder matching the specified file type are displayed in the file list on the left. Click on a file to view its attributes (in lower left), associated regions

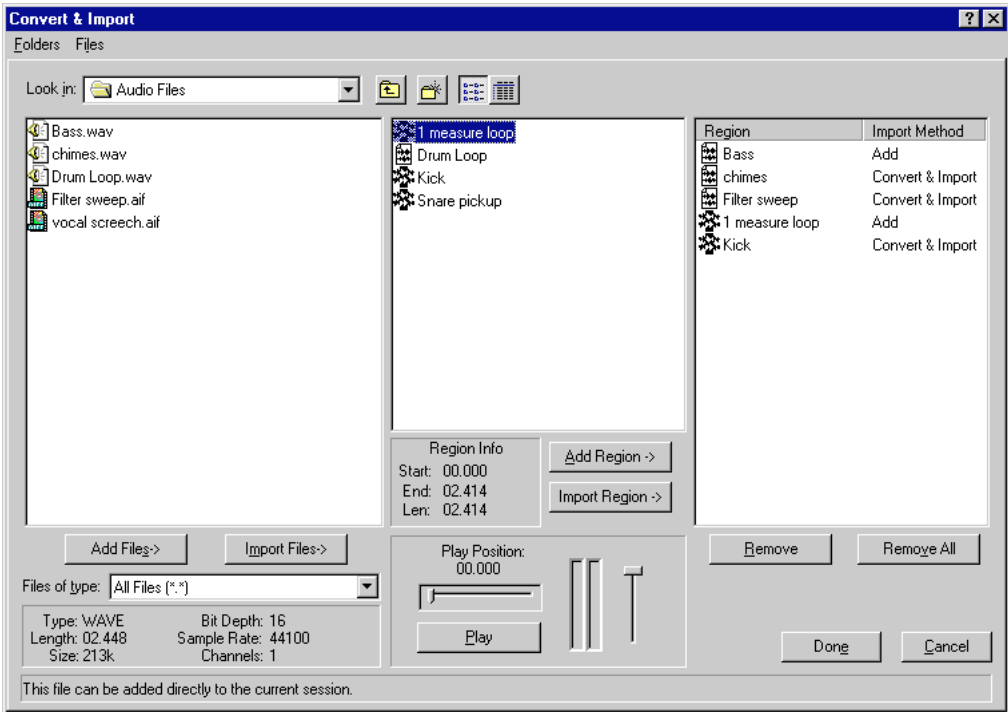

Figure 5. Convert & Import dialog (Windows)

(in center), and whether it will need to be converted (in Status Bar at bottom). Right-click in this list area to change the display of the folder's contents.

The center list displays the regions associated with the currently selected audio file. One region name reflects the original audio file, or the "whole-file region." Importing this region loads the entire source file into the session.

**4** To audition a selected file or region before you import it, click Play. To go to a particular location in the selected file or region, move the Play Position slider. Adjust the playback volume with the vertical slider on the right.

**5** To place an audio file in the import list on the right, select the file and click Add Files.

– or –

To import a copy of the audio file, click Import Files.

**6** To place a region in the import list on the right, select the region and click Add Region. This button is only available if the region does not need to be converted.

– or –

To import a copy of the region, click Import Region.

In the import list, audio files are distinguished from regions by their icons.



Icons for audio files (left) and regions (right)

Also indicated in the import list is whether Pro Tools will use “Add” or “Convert & Import” for the file or region. The latter imports a copy of the audio file or region.

**7** To import any recently opened audio files or regions, choose them from the Files menu at the top of the Convert & Import dialog. This places them directly into the import list.

**8** To remove a file or region from the import list, select it and click Remove. To remove all items in the import list, click Remove All.

**9** Once the audio files and regions have been added to the import list on the right, click Done.

Each of the files and regions from the import list are imported into their own audio track, and also appear as regions in the Audio Regions List.

If importing copies of any audio files or regions, or if some files need to be converted, specify a destination for the new files.

#### To import audio into the Audio Regions List:

**1** Choose Import Audio from the Audio Regions List pop-up menu.

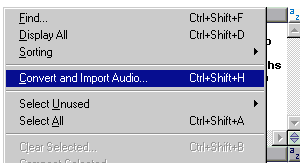

Import Audio command (Windows)

**2** In the Convert & Import dialog (see Figure 5 on page 123), select a file type to display and locate the audio files you want to import.

**3** Select audio files from the list on the left and click Add Files to place them in the import list on the right.

– or –

Click Import Files to import a copy of the selected file.

**4** Select regions from the list in the center and click Add Region to place them in the import list. This button is only available if the region does not need to be converted.

– or –

Click Import Region to import a copy of the selected region.

**5** To remove a file or region from the import list on the right, select it and click Remove. To remove all items in the import list, click Remove All.

**6** Once the audio files and regions have been added to the import list, click Done.

Each of the files and regions from the import list are imported and appear in the Audio Regions List.

If importing copies of any audio files or regions, or if some files need to be converted, specify a destination for the new files.



---

## Recalculating Waveform Overviews

When the Display Preference for “Recompute Invalid Waveforms” is not enabled, waveforms are not displayed for audio files that are imported.

Waveforms for these files can be displayed with the Recalculate Waveform Overviews command.

### To display waveforms for an imported audio region:

- 1 In the Audio Regions List, select any regions that are not displaying their waveforms.
- 2 Choose Recalculate Waveform Overviews from the pop-up menu in the Audio Regions List.

---

## Loading Audio Files with Drag & Drop

Pro Tools provides you with a convenient method of batch loading any number of audio files into an open session.

### To batch load audio files into a session:

- 1 Open the Pro Tools session.
- 2 From the desktop, locate the audio files you want to import. Make sure the files match the session’s file type, bit depth, and sample rate.
- 3 Drag the audio files onto the Pro Tools application icon.

The audio files are automatically imported and appear in the Audio Regions List. If a stereo interleaved file was imported,

Pro Tools converts it to two mono files and saves them to the “Audio Files” folder for the current session.

---

## Transferring Audio from CD

### (Macintosh Only)

Pro Tools allows you to transfer audio tracks from an audio CD with the Import Audio From Movie Audio command. Since the transfer is made in the digital domain, there is no signal loss.

The sample rate for audio CDs is 44.1 kHz. Therefore, if your session’s sample rate is set to 48 kHz, Pro Tools will convert the sample rate for the imported audio. Before importing CD audio, make sure to set the Conversion Quality Preference accordingly. See “Conversion Quality” on page 126 for details.

When importing a CD audio track, Pro Tools first imports it as QuickTime movie. The imported movie is then converted to Sound Designer II audio files, which can be used in your Pro Tools session. Before importing CD audio, make sure your hard disk has enough space for both the imported movie file *and* the converted audio files.

### To import a CD audio track:

- 1 Insert the audio CD into your CD-ROM drive.
- 2 Choose Movie > Import Audio From Other Movie.
- 3 Locate and select the audio track to be imported, then click Convert.

4 When the Save dialog appears, click the Options button.

5 In the Options dialog, select the sample rate, bit resolution, and stereo format.

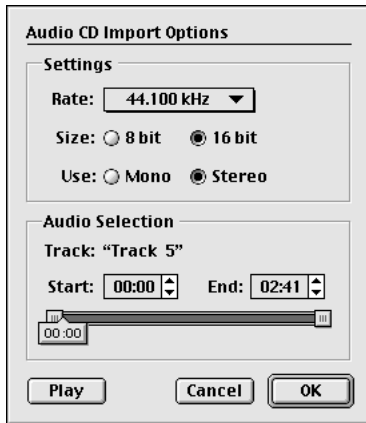

*Audio CD Import Options dialog (Macintosh)*

6 At the bottom of the Options dialog, set the range of the audio track to be imported by adjusting the Start and End times, then click OK.

7 Specify the destination for the imported audio track and click Save. Pro Tools imports the CD audio track as a QuickTime movie and writes it to your hard disk.

8 When the Track Import window appears, click OK.

Pro Tools converts the audio track to your session's sample rate and bit resolution and imports the selected audio tracks into the Audio Regions List. From there you can drag the regions to existing tracks.

---

## Conversion Quality

The Conversion Quality Preference determines the quality of sample rate conversion used when converting and importing audio into a session, and when importing CD audio tracks (Macintosh only). There are five possible settings, ranging from *Low* to *Tweak Head*. The higher the quality, the longer it will take for the sample rate conversion.

**To set the sample rate conversion quality:**

- 1 Choose **Setup > Preferences**, and click **Editing**.
- 2 From the **Conversion Quality** pop-up menu, select the desired quality.

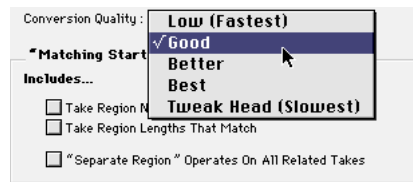

### *Conversion Quality preference*

For most applications, the Good or Better setting will yield very good results. Because the Best and Tweak Head settings take significantly longer, use them only when higher fidelity is absolutely essential.

- 3 Click Done.

Slower computers can take an extremely long time to perform sample rate conversion, especially at higher-quality settings. The Tweak Head setting, for instance, can take as long as several hours to process an audio file of moderate length.

---

## Exporting Audio

The following sections discuss exporting regions as audio files, exporting left and right audio files as stereo interleaved files, exporting region information, and transferring entire tracks between sessions (Macintosh only).

You can also export audio from Pro Tools by bouncing or consolidating audio tracks. For more information, see “Bouncing Tracks to Disk” on page 313 and “Consolidate Selection Command” on page 196.

### Exporting a Region as a New Audio File

You can export regions as audio files with the Export Selected As Files command. Use this command if you intend to use a region in other sessions (or other audio applications) without using its parent source file.

This command also provides a way to convert regions to a different audio format, sample rate, or bit depth.

#### To export regions as new audio files:

- 1 In the Audio Regions List, select the regions you want to export.
- 2 From the Audio Regions List pop-up menu, choose Export Selected As Files.
- 3 In the Output Options dialog, set the files’ format, sample rate, bit depth, and stereo mode. In addition, specify the Conversion Quality and destination parameters.

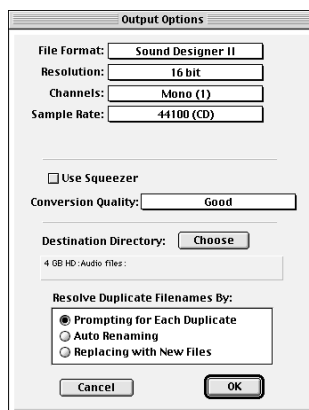

*Output Options dialog*

For more information on the output parameters, see “Output Options” on page 315.

- 4 Once the Output Options are configured, click OK to export the new audio files.

### Exporting Stereo Interleaved Files

You can also use the Export Selected As Files command to export audio regions to stereo interleaved files. For this to work, the selected regions must have identical names with “.L” and “.R” suffixes (for instance, vocals-01.L and vocals-01.R).

#### To export regions as a stereo interleaved file:

- 1 Select the left and right audio regions in the Audio Regions List or Edit window.
- 2 From the Audio Regions List pop-up menu, choose Export Selected As Files.
- 3 In the Output Options dialog, select “Stereo from .L/.R” in the Channels pop-up menu.
- 4 Configure any other output parameters, then click OK to export the new stereo interleaved file.

## Exporting Region Definitions

Pro Tools stores region definitions for audio files within each session. If you want to use an audio file's regions in another session, or with another application that supports them, you can export the region information.

The Export Region Definitions command does not export regions as audio files (unlike the Export Selected As Files command). Instead, it stores pointers to the regions within the parent source file.

### To export region definitions for an audio file:

- 1 In the Audio Regions List, select any regions for which you want to export definitions. You do not have to select the audio region for the region's parent audio file.
- 2 Choose Export Region Definitions from the Audio Regions List pop-up menu.
- 3 Click Export.

## Track Transfer Utility

### (Macintosh Only)

The Track Transfer™ utility software (included with your Macintosh Pro Tools system) lets you import, export, or merge entire track entities (including region definitions) into other sessions. For details, see the online documentation included with the Track Transfer software.

---

## Importing MIDI Files

You can import Standard MIDI Files into your Pro Tools sessions. Use the File > Import MIDI/Track command to place the imported MIDI onto new tracks; or use the Import MIDI command in the MIDI Regions List pop-up menu to place the data in the MIDI Regions List, where it can be dragged to existing tracks.

Pro Tools does not import proprietary sequence files. To use sequences from other MIDI applications in a Pro Tools session, you'll need to first save them as Standard MIDI Files. Refer to the manufacturer's documentation for details on saving Standard MIDI Files.

There are two types of Standard MIDI Files, both of which are supported by Pro Tools:

- ◆ Type 0 MIDI files store data for all MIDI channels in a single track. When importing these files, Pro Tools separates the data by channel and places them in separate regions and tracks
- ◆ Type 1 MIDI files, sometimes referred to as multitrack MIDI files, contain multiple tracks of MIDI data. When importing these files, each track's data is placed on its own new MIDI track in the Pro Tools session.

### To import a Standard MIDI File to new tracks:

- 1 Choose File > Import MIDI/Track.
- 2 Select the MIDI file you want to import.

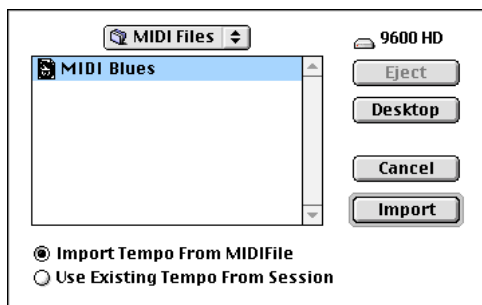

*Import MIDI dialog*

- 3 To import the MIDI file's tempo and meter tracks, select the option for Import Tempo From MIDI File.

This option overwrites existing meter and tempo events in the current session. If you don't want this, make sure to instead select Use Existing Tempo From Session.

- 4 Click Import. If prompted, specify whether you want to Keep or Discard existing MIDI tracks and regions in the current session.

The MIDI data is imported to new MIDI tracks, and also appears as regions in the MIDI Regions List.

---

▲ If the Standard MIDI File contains markers, they are only imported if the current session does not contain any markers.

---

- 5 In the Mix window, click on the MIDI Device/Channel selector for each new track and assign a MIDI instrument and channel.

### To import a Standard MIDI File into the MIDI Regions List:

- 1 Choose Import MIDI from the MIDI Regions List pop-up menu.
- 2 Select the MIDI file you want to import.
- 3 To import the MIDI file's tempo and meter tracks, select the option for Import Tempo From MIDI File.

This option overwrites existing meter and tempo events in the current session. If you don't want this, make sure to instead select Use Existing Tempo From Session.

- 4 Click Import. If prompted, specify whether you want to Keep or Discard existing MIDI tracks and regions residing in the current session.

Pro Tools imports the MIDI data as regions and places them in the MIDI Regions List.

---

▲ If the Standard MIDI File contains markers, they are only imported if the current session does not contain any markers.

---

- 5 Drag the new MIDI regions, as desired, to existing MIDI tracks.

---

## Exporting MIDI Files

To export a session's MIDI tracks for use in another MIDI application, or for playback with an external (hardware) MIDI sequencer, you can save the tracks as a Standard MIDI File.

When exporting, the session tracks can be merged to a single, multi-channel track (Type 0), or they can be saved as multiple tracks (Type 1).

**To export all MIDI tracks in the current session:**

- 1 Make sure to unmute any MIDI tracks in the session that you want to export.
- 2 Choose File > Export MIDI.
- 3 Specify a folder destination and name for the MIDI file.

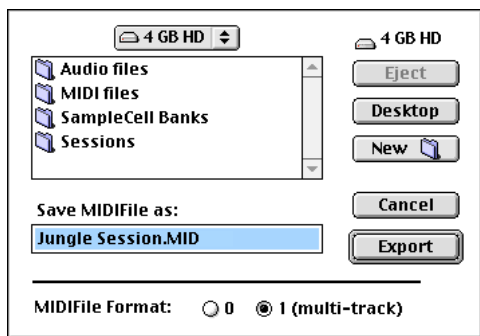

*Export MIDI dialog*

- 4 Select whether the Standard MIDI File will be Type 0 (merged, single track) or Type 1 (multi-track).
- 5 Click Export. Pro Tools exports all MIDI tracks in the current session to a Standard MIDI File and writes it to your hard drive. Exported MIDI includes notes, controller events, program changes, System Exclusive data, as well as events for tempo, meter, and markers.

The SMPTE start time for the session is also imported. This ensures that the exported tracks, when played from another MIDI application, will align with the correct SMPTE frames, and also sync correctly to tape and video devices, or Pro Tools.

Refer to your third-party MIDI sequencer documentation to determine whether it supports importing SMPTE start times from MIDI files.

## **What's Not Exported with MIDI Files**

Mute automation and muted regions do not affect exported MIDI. As long as a track is not muted by clicking its Mute button, all of its MIDI data is exported.

When exporting MIDI files from Pro Tools, device assignments for tracks are not retained (though channel assignments are). If you therefore export MIDI tracks from Pro Tools and later re-import them, you'll need to reassign the tracks to the desired devices.

All playlist information for MIDI tracks is lost when exporting. For instance, tracks that previously contained dozens of MIDI regions will be flattened and only contain single regions after exporting and re-importing.

# **Part IV**

## **Editing**





# Editing Basics

---

## Pro Tools Editing

The Edit window in Pro Tools provides a powerful collection of tools for editing and assembling audio and MIDI tracks. Track material can be edited non-destructively and in real time during playback.

## Nondestructive Editing

The vast majority of audio editing in Pro Tools is nondestructive. Whether cutting, pasting, trimming, separating, or clearing regions, you are only performing these functions on a map of the actual audio data. The source audio files remain untouched. If a particular process or tool works destructively (that is, if it can permanently change audio files on your hard disk), this guide alerts you.

While editing for MIDI tracks is in some instances destructive, with a few precautions you can keep important MIDI tracks and regions safe when performing edits (see “Nondestructive MIDI Editing” on page 141).

## Editing During Playback

Pro Tools lets you perform many editing tasks while the session plays. This powerful capability allows you to interactively modify and edit a session, hearing the changes as you make them. You’ll find many instances where you can use this capability to increase your productivity when working with a session.

Following are just a few examples of editing that can be performed while your tracks loop or play:

- Capture, separate, and trim regions
- Place, spot, or rearrange regions
- Add fades or crossfades to audio regions
- Transpose, quantize, and otherwise modify MIDI tracks
- Nudge audio or MIDI regions
- Audition different playlists
- Adjust or scale automation data
- Process audio with an AudioSuite Plug-In

---

▲ There are a few things that can not be changed while Pro Tools plays back. These include assigning audio tracks to TDM Plug-Ins, routing to sends, and assigning outputs.

---

---

## Track Material

Each time you record or import audio and MIDI, Pro Tools creates *regions* for the new track data, which not only indicate where the material begins and ends, but also provides good feedback on its general shape and content. When you record additional takes, or “punch in” on a specific location within a track, Pro Tools creates additional regions.

Regions are also created by cutting and pasting, resizing, separating, and re-capturing existing regions. Regions in a session are listed in the Audio Regions List and MIDI Regions List, where they can be dragged to existing tracks. A track can contain any number of regions, in any arrangement. The order and location of regions in a track define its *playlist*.

Following is a description of the different region types and how they are created:

**Whole-File Audio Regions** These regions are created when recording or importing audio, consolidating existing regions, and when non-destructively processing with an AudioSuite Plug-In. These regions reference an entire audio file that resides on your hard drive. Whole-file regions are displayed in bold in the Audio Regions List (see “The Audio and MIDI Regions Lists” on page 143). Normal regions reference only a portion of the parent audio file and are created in the course of editing and, in some instances, when punch recording.

**User-Defined Regions** These are regions that are explicitly defined, such as when you record or import audio or MIDI; capture,

separate, or consolidate a selection; trim a whole-file audio region; and rename an existing region.

**Auto-Created Regions** These regions are automatically created in the course of editing, and, in some instances, when punch recording over existing regions. Since these regions can accumulate rapidly in a session, you can hide them so they don’t appear in the Audio and MIDI Regions List (see “Managing Regions” on page 196). Auto-created regions can be turned into user-created regions by renaming them.

## Track Display Format

The Display Format for each track determines which data is displayed and edited in the track’s playlist area.

Audio tracks can be set to *Blocks*, *Waveform*, *Volume*, *Pan*, *Mute*, or any Plug-In parameters that have been automated. Except when editing automation data, audio tracks are usually set to *Waveform*, where track material is graphically drawn with amplitude waveforms. This Display Format provides the necessary detail for important region edits.

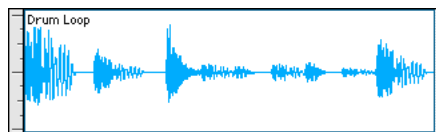

*Display Format set to Waveform for audio track*

Auxiliary input tracks can be set to *Volume*, *Pan*, *Mute*, or any Plug-In parameter that has been automated. Master Fader tracks can be set to *Volume*, or any Plug-In parameter that has been automated.

MIDI tracks can be set to *Blocks, Regions, Notes, Volume, Pan, Mute, Velocity, Pitch Bend, After Touch, Program, Sys Ex*, and any continuous controller type. Except when editing controller data, program changes, or sysex events, MIDI tracks are usually set to Notes or Regions, each of which displays notes in a “piano roll” format. Use Notes view for inserting, editing, and copying and pasting MIDI notes; use Regions view to arrange, capture, or consolidate regions.

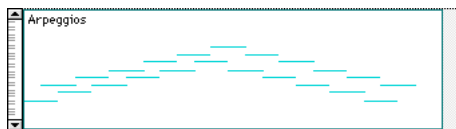

**Display Format set to Regions for MIDI track**

With the Display Format set to Blocks, audio and MIDI regions are displayed as empty blocks bearing the region’s name. This mode is most useful once you have finished capturing and editing regions at the waveform or MIDI event level and are moving and rearranging them. Screen redraws are fastest with this format.

When an audio track is displayed as Volume, Pan, or another automated parameter, or when a MIDI track is set to one of the continuous controller types (Volume, Pitch Bend, After Touch), the data for that track appears in the form of a line graph with a series of editable breakpoints. The breakpoints can be dragged to modify the automation data, and new breakpoints can be inserted with the Pencil or Grabber.

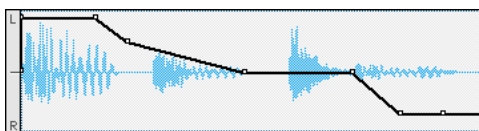

**Display Format set to Pan for audio track**

For details on inserting and editing controller data for MIDI tracks, see “Continuous Controller Events” on page 207. For details on editing automation data for audio tracks, see *Chapter 21: Automation*.

### To set a track’s Display Format:

- Click on the Display Format Selector for the track and choose the format from the pop-up menu.



**Display Format Selector**

The track displays the new format. If the track is part of an Edit Group, all tracks in the group are set to the new format.

### The “Master” View Format

Audio and MIDI tracks have Display Formats that act as “master.” When a track is displayed in its master format, any edits performed apply to all data in the track. For instance, when an audio track is set to Waveform, copying and pasting affects not just the waveform information, but all of the automation data as well.

The display formats that act as master for audio and MIDI tracks are:

- Audio tracks: Waveform and Blocks
- MIDI tracks: Regions, Blocks, and Notes (when using the Selector)

---

\* Auxiliary Input tracks and Master Fader tracks do not have a master view.

---

## Track Height

Tracks can be viewed in the Edit window at any of six heights: *Mini*, *Small*, *Medium*, *Large*, *Jumbo*, and *Extreme*. Larger track heights are particularly useful for precise editing. Smaller track heights are useful for conserving screen space in a large session.

You can adjust track heights on an individual track basis or set all tracks to the same height. Track heights can be adjusted during playback.

### To set a track height:

- Click on the area just to the right of the track controls and choose the height from the Track Height.



Track Height pop-up menu

– or –

Click on the small arrow next to the Display Format to get the Track Height pop-up.

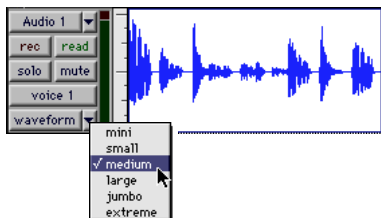

Track Height pop-up menu

The track is resized to the new height. If the track is part of an Edit Group, all tracks in the group are set to the new height.

## Track Controls and Track Height

The Track Height affects how the various track controls appear in the Edit window. For instance, when a track's height is set to Small, most of the buttons are reduced in size, and the menus for Track Height and Display format are accessed from the same pop-up.

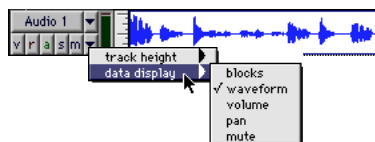

Track Height set to Small

When the Track Height is set to Mini, only controls for Mute and Solo appear, and the menus for Playlist, Track Height, and Display Format are accessed from the same pop-up.

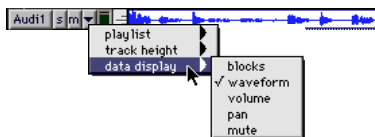

Track Height set to Mini

When the Track Height is set to Large, Jumbo, or Extreme, all track controls are displayed at their full size.

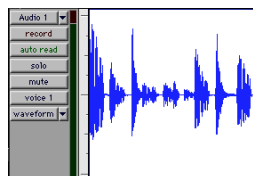

Track Height set to Large

---

## Displaying Region Names and Times

Region names can sometimes get in the way of editing audio waveforms and MIDI data. In these instances you may want to disable their display.

### To disable the display of region names in playlists:

- Deselect Display > Display Name In Regions.

You can choose to display region time code locations in the playlist area. This is extremely useful when working with film and video.

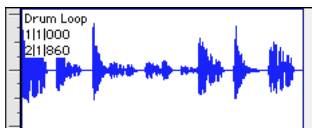

Display enabled for region names and times

### To display region times:

- From Display > Display Time In Regions, select one of the following options:

**None** Disables display of region times.

**Current Time** Displays start and end times for regions.

**Original Time Stamp** Displays the Original Time Stamp for each region. The Original Time Stamp is the original time code location for the region when it was first recorded or created.

**User Time Stamp** Displays the User Time Stamp for each region. The User Time Stamp, which default to the Original Time Stamp, can be redefined with the Time Stamp Selected command.

---

## Audio Regions and Waveforms

When the Display Format for audio tracks is set to Waveform, Pro Tools draws a waveform diagram of the audio. Audio waveforms tell you several things about the recorded sound.

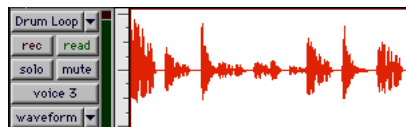

Figure 6. Audio waveform of drum loop

Figure 6 shows an audio waveform for a drum loop. The “peaks” represent places in the recording (beats) where the attack of the sound causes the volume to increase momentarily. These are followed by “valleys,” where the volume decreases.

Different types of sounds produce different types of waveforms. Drums, for example, generally produce waveforms with sharp *transients* (peaks of short duration) that are clearly defined. A drum hit has a loud, sharp attack and a rapid decay.

Other sounds, such as vocals or sustained keyboard sounds, produce very different waveforms, ones that have less pronounced peaks and valleys. That’s because these sounds generally have softer attacks and longer decays.

### Draw Waveforms Rectified Preference

When the Display Preference for Draw Waveforms Rectified is selected, audio waveforms are displayed so that their posi-

tive and negative waveform excursions are summed together and viewed as a single positive-value signal.

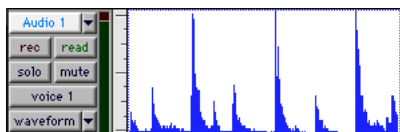

Audio displayed in rectified mode

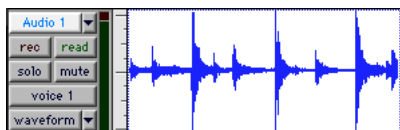

Audio displayed in normal mode

Rectified mode displays more detailed waveforms when using track heights of Medium or Small, and can be particularly useful when editing volume automation data, since it depicts waveform “levels” as starting at the bottom of the track.

## Guidelines for Editing Waveforms

With the Selector tool in the Edit window, you can select portions of audio waveforms and divide them into segments called *regions*, so that you can rearrange and manipulate them in tracks.

While editing, try to create regions that allow you to maintain a consistent beat. If you always define regions so that they contain a whole number of beats, you’ll be able to string the regions together and maintain a smooth, steady rhythm.

It’s sometimes useful to have a steady, well-defined waveform, such as a drum track, as a guide when selecting and defining other regions. If you’ve played in time with the

beat, chances are that you can create rhythmically accurate regions by referring to the drum’s waveform.

Some important rules to keep in mind when defining regions:

- ◆ Whenever possible, begin a region precisely before a volume peak, and end it immediately before another volume peak.
- ◆ Whenever possible, make sure a region starts and ends on exactly the same part of a beat.

## Avoiding Clicks and Pops

If an edited region begins or ends at a point of high amplitude, you may hear an unpleasant click when Pro Tools plays from one region to another. In order to avoid clicks or pops do any of the following:

- ◆ Make sure that the start and end points of your selection are as close as possible to the point where the amplitude of the waveform tapers down to meet the zero-crossing line (the center line of the track’s waveform display). If necessary, use the zooming tools in the Edit window (see “Zooming” on page 147) to display waveforms in greater detail.

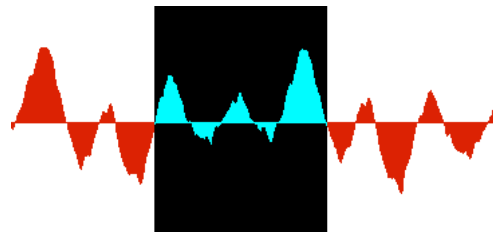

Selection that begins and ends at zero crossings

- ◆ On Pro Tools 24 MIX and Pro Tools 24 systems, use the AutoFade feature to apply real-time fade-ins/outs to all region bound-

aries that do not touch or overlap other regions. See “Using the AutoFade Feature” on page 254 for details.

◆ Apply a crossfade between regions where a click or pop occurs. See “Creating a Crossfade” on page 251 for details.

## Nondestructive Audio Editing

When editing an audio track’s playlist in Pro Tools, you’re not actually cutting and moving pieces of sound as you would if you were cutting and splicing analog tape. Instead, Pro Tools creates a map of the audio file on your hard disk, which describes the order in which to play the track portions.

When trimming audio regions with the Trimmer tool, or when editing the placement or order of regions within a track, use multiple playlists to easily return to a track’s previous state. See “Playlists” on page 141 for details.

## Audio Regions and Automation Data

Automation data for audio resides in tracks and *not* regions. This means that when you drag an audio region from the Audio Regions List to a new track, no automation data is placed in the track. However, if you drag an audio region from an existing track (that contains automation data) to another track, the automation from the source track is placed in the destination track.

## MIDI Regions and MIDI Data

The two most common Display Formats you’ll use for MIDI tracks are Notes and Regions. Use Notes view for inserting and editing individual MIDI notes, and for working with and affecting groups of notes.

When you need to experiment with the arrangement of regions, or define new ones, use Regions view.

## MIDI Notes Display

When a MIDI track’s Display Format is set to Notes, MIDI notes are displayed in a “piano roll” format. Each note is displayed as a small rectangle with its vertical placement indicating pitch and its horizontal placement indicating location.

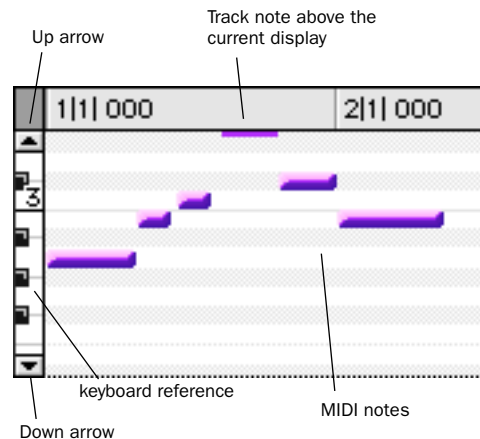

Figure 7. MIDI track displaying notes

To the left of the MIDI track’s playlist is a vertical mini-keyboard, complete with octave numbering, for pitch reference. You can Command-click (Macintosh) or Control-click (Windows) the mini-keyboard to

audition pitches. Arrows at the top and bottom of the mini-keyboard (not available in the smaller track heights) are used to scroll the Notes display up and down.

The pitch range of MIDI notes that can be displayed depends on the track height, and on the current zoom value. Any time a track's notes do not fit within its current height, notes above or below the viewed area are displayed as single-pixel lines at the very top and bottom of the range (see Figure 7).

#### To scroll the Notes display up or down for a MIDI track:

- Click on either the up or down arrow of the mini-keyboard.

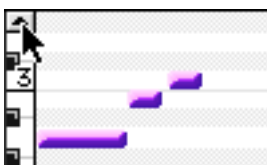

Scroll arrow for mini-keyboard

– or –

With the Pencil tool selected, press Command+Option+Control (Macintosh) or Control+Alt+Start (Windows) and drag up or down.

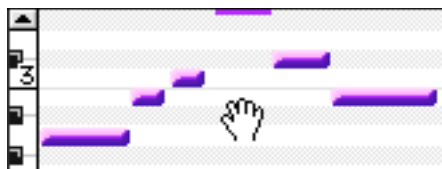

Scrolling Notes display by dragging

Using the Edit window tools, notes can be inserted, transposed, trimmed, and moved. For more information, see “Manually Editing MIDI Notes” on page 202.

## MIDI Regions Display

MIDI tracks can also be viewed as Regions, which is similar to Waveform view for audio tracks. While a track's notes are visible in Regions view, individual note editing is not available in this view. Instead, all editing occurs across a time range encompassing all track data, including continuous controller events, program changes, and System Exclusive events.

Use Regions view to define regions that represent song sections and clips, or to rearrange or assemble track material.

There are, however, a few things to keep in mind when selecting, copying and cutting, and trimming MIDI regions:

- ◆ When cutting or clearing a region selection that includes a note's start point, the entire note is removed. This is even the case when only a portion of the note (that includes its start point) is selected.
- ◆ When copying or cutting a region selection that includes a note's end point (but not its start point), the note remains and overlaps the edge of the region.

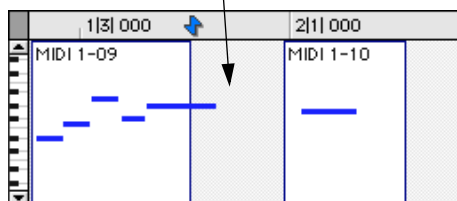
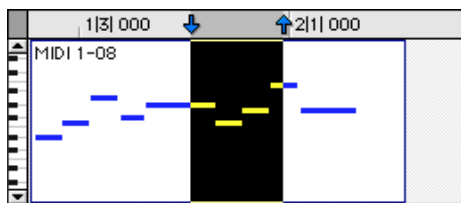

MIDI region with note overlap



◆ Similar rules also apply when MIDI regions are trimmed with the Trimmer tool. If the MIDI region's start point is moved beyond a note's start point, the note is removed. If the region's end point is trimmed so that a note's start point is within the region but its end point is not, the note remains and overlaps the edge of the region.

When moving and placing MIDI regions with overlapping notes, the notes always move with the regions. When placing MIDI regions with overlapping notes next to or near another region, the overlapping notes extend into the adjacent region.

## Nondestructive MIDI Editing

While editing audio regions is usually non-destructive, this is not always the case for MIDI regions. For instance, if a MIDI region resides in just one track at a single location, editing for that region *is* destructive. This means that altering the pitch, duration, or placement of notes in Notes view permanently alters the region.

However, when editing a MIDI region that occurs elsewhere, in the same track (at another location or in a different playlist) or in another track, the editing is nondestructive and occurs to an auto-created region. To go back to the previous material, drag the original region from the MIDI Regions List, or return to a previously saved playlist.

---

\* One way to safely return to a track's previous state is with playlists. Before you edit notes, trim regions, or rearrange the order of regions, make a duplicate of the track's existing playlist and instead work with it (see "Playlists" on page 141).

---

## MIDI Regions and Controller Events

Continuous controller events reside in MIDI regions and not in tracks. This means that when dragging regions that contain controller data from either a track or the MIDI Regions List, the controller data is written to the destination track.

Unlike continuous controller events, which represent nuances that are part of a MIDI performance, Mute in Pro Tools is an automation playlist that actually mutes the MIDI engine. Mute automation does not correspond to actual MIDI events and is therefore not exported when saving as a Standard MIDI File.

---

## Playlists

The ability to create *playlists* is one of the most powerful features of Pro Tools, and one reason why it is infinitely more versatile than traditional multitrack recorders.

*Edit playlists* allow you to take a snapshot of a track's current arrangement of regions, thereby freeing you to experiment with alternate arrangements, returning as necessary to previously saved playlists.

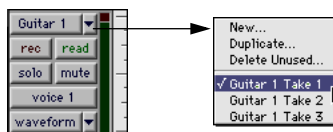

**Playlist Selector pop-up**

A playlist, which can consist of a single region or many regions, can only be assigned to a track if it is not in use by another track. While you can create an almost unlimited

number of edit playlists, which are shared among all tracks, each track has its own set of dedicated *automation playlists*.

---

▲ Automation playlists for audio tracks store data for volume, pan, mute, and Plug-In parameters. Automation playlists for MIDI tracks, however, store *only* mute information; continuous controller events, program changes, and sysex events are stored in MIDI regions and therefore reside within edit playlists.

---

## Working with Playlists

When you add a new track to a session, its playlist is empty until you record or import material to it, or drag a region to it from the Audio or MIDI Regions List.

When you edit a track, you can work with a copy of the track's playlist and keep the original playlist arrangement intact.

### To duplicate a track's current playlist:

- 1 Click on the track's Playlist Selector and choose Duplicate from the pop-up menu.
- 2 Enter a name for the new playlist and click OK.

The duplicated playlist appears in the track and the track's name is changed to the name of the new playlist.

You can also create a new playlist and record or drag regions to it.

### To create a new (empty) playlist:

- 1 Click on the track's Playlist Selector and choose New from the pop-up menu.
- 2 Enter a name for the new playlist and click OK.

An empty playlist with the specified name appears in the track.

As long as a playlist is unassigned, it can be recalled and assigned to any track. Only unassigned playlists appear in the Playlist Selector pop-up.

### To recall and assign a playlist:

- Click on the track's Playlist Selector and choose the playlist from the pop-up menu.

The selected playlist appears in the track and the track's name is updated to that of the selected playlist.

## Renaming a Playlist

You can rename a playlist by renaming the track to which it is assigned.

### To rename a track's assigned playlist:

- 1 Double-click the track's name.
- 2 Enter a new name and click OK. Both the track and playlist names are updated.

## Deleting a Playlist

You can delete a playlist from a session entirely. However, since playlists take almost no disk space, you don't need to delete them for space reasons.

### To delete the current playlist for a track:

- 1 Click on the track's Playlist Selector and choose Delete Unused from the pop-up menu.
- 2 Select the unassigned playlists you want to delete. Shift-click to select multiple playlists.
- 3 Click OK to delete the playlists. This operation cannot be undone.

## The Audio and MIDI Regions Lists

All regions that are recorded, imported, or created by editing appear in the Audio and MIDI Regions Lists. Regions can be dragged from either list to tracks and arranged in any order. Regions can also be auditioned from the Regions List by Option-clicking them.

Because region names can become lengthy (up to 31 characters), the Regions List can be scrolled or resized as necessary (see Figure 8). In addition, you can use the pop-up menu at the top of either list to sort, search, rename, and clear regions.

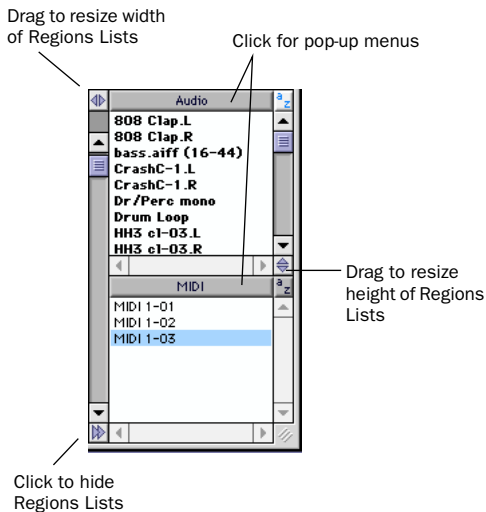

Figure 8. Audio and MIDI Regions Lists

If the Editing Preference for “Region List Selection Follows Track Selection” is enabled, clicking a region in the Regions List highlights it in the track that contains it.

\* Use the MIDI Regions List as a bin for storing your favorite MIDI clips. Save the session as a template (see “Creating Custom Session Templates” on page 48) and the regions are available for future sessions. Since MIDI regions are tick-based (unlike audio regions), they scale seamlessly for use with any tempo.

## Displaying File Info for Audio Regions

In addition to region names, the Audio Regions List can also display information about the region’s parent audio file:

- File name, which represents the audio file from which the region originated
- Disk name, which represents the name of the hard drive on which it resides
- The full directory Pathname of the region’s location

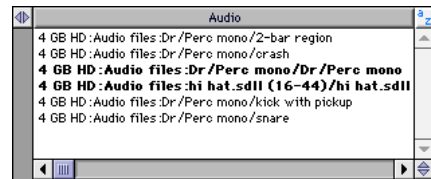

### Audio Regions with file info

Pro Tools defaults to displaying just the region portion of a region’s name. To display file info for audio regions, choose Show File Names, Show Disk Names, or Show Full Pathnames from the pop-up menu at the top of the Audio Regions List.

## Sorting and Searching the Regions Lists

Most sessions will contain many regions, which may make it difficult to locate a particular region in the Regions Lists. The ability to sort regions and search for them will help greatly in keeping track of large numbers of regions.

### To sort regions in a Regions List:

**1** From the Regions List pop-up menu, choose Sorting and select the basis for sorting from the submenu.

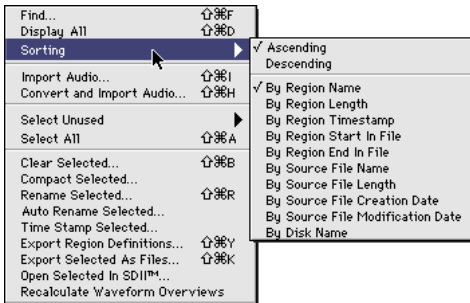

### Sort attributes for audio regions

MIDI regions can be sorted by name, length, or timestamp. In addition to these, audio regions can be sorted by region start and end times, and by various attributes for the source audio file.

**2** From the Regions List pop-up menu, select Ascending or Descending to switch the order of the displayed regions.

## Keyboard Selection of Regions

If the Audio Regions List Key focus or MIDI Regions List Key focus is enabled, you can type the first few letters of a region's name and Pro Tools will automatically locate and select the region in the Regions List.

### To enable and use the Audio Regions List Key focus or MIDI Regions List Key focus:

**1** Click the a-z button in upper right of the Audio Regions List or MIDI Regions List.

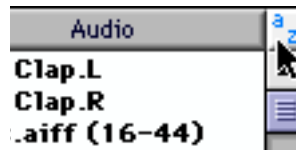

### Audio Regions List Key focus enabled

**2** Type the first few letters of the region to automatically locate and select it. Once a region is located and selected, it can be dragged to a track.

Keyboard selection of audio regions locates regions based on their region name, not on the names for their parent audio files or the volumes on which they reside.

## Finding Regions

Use the Find command to display all regions in a list whose names contain a particular word or phrase.

### To find and display regions that match a word or phrase:

- 1 Choose Find from the pop-up menu in the Audio or MIDI Regions List.
- 2 Type the name, or any portion of the name, for the regions you want to find, then click OK.



Figure 9. Regions located with Find command

Pro Tools displays all regions whose names contain the name that was specified.

Figure 9 shows regions found when searching on the word “loop.” When displaying regions with the Find command, a small diamond appears at the top of the Audio and MIDI Regions List.

### To return the Regions List to displaying all regions:

- Choose Display All from the Regions List pop-up menu.

## Edit Modes

Pro Tools has four Edit modes: Shuffle, Spot, Slip, and Grid. The Edit mode is selected by clicking the desired button in the upper left of the Edit window.



Edit mode buttons

- \* You can also use F1 (Shuffle), F2 (Slip), F3 (Spot), and F4 (Grid) to set the Edit mode.

The Edit mode affects the movement and placement of audio and MIDI regions (and individual MIDI notes), how commands like Copy and Paste function, and also how the various edit tools (Trimmer, Selector, Grabber, and Pencil) work.

## Shuffle

In Shuffle mode, you can move regions freely within a track or to other tracks, but their movement is constrained by other regions. That is, if you place several regions in a track, they automatically snap to each other. You can then “shuffle” their order, but you cannot separate them from each other and you cannot make them overlap as in Slip mode. In Shuffle mode, adding another region to the beginning of a track moves all subsequent regions to the right by the length of the region added.

When using the Trimmer in Shuffle mode, changing a region’s start or end point automatically moves the adjacent regions as necessary. The placement and insertion of MIDI notes is not affected by Shuffle mode.

## Slip

In Slip mode, regions can be moved freely within a track or to other tracks. In this mode it is possible to place a region so that there is space between it and other regions in a track. When the track is played back, this space is silent. It is also possible to move a region so that it overlaps or completely covers another region.

Use Slip mode when you want the Trimmer, Selector, Grabber, and Pencil tools to work without any restrictions to placement in time.

## Spot

Use Spot mode to place regions at precise locations. This can be particularly useful when performing post production tasks around SMPTE frame locations. In this mode you can specify a frame location (or a location based on any of the other time formats), capture an incoming Time Code address, or use a region's time stamps as reference points for spotting.

In Spot mode, when you move or trim regions, the Spot dialog opens.

## Grid

In Grid mode, regions and MIDI notes that are moved or inserted “snap” to a user-definable time grid. In addition to placing material cleanly on the beat, Grid mode is also useful for making precise Edit and Timeline selections.

The actual grid size, chosen from the Grid Value pop-up in the upper right of the Edit window, can be based on a time value using the Main Time Scale; or, if Follow Main Time Scale is deselected, another time format can be used for the grid size.

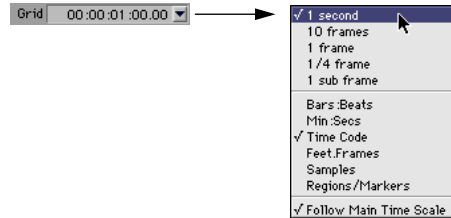

### Grid Value set to 1 second

\* The current Grid Value is also used for the Quantize Regions Command.

Also available in the Grid Value pop-up is an option for Regions/Markers. When selected, events can be placed freely (as in Slip mode) but will snap to region locations (start, end, and sync points), Markers, and Edit selections when placed near them.

▲ Notes inserted with the Pencil tool ignore the Regions/Markers option, and instead snap to the time value selected in the Grid Value pop-up.

To display the grid lines in the Edit window, enable the Display Preference for “Draw Grids in Edit Window.”

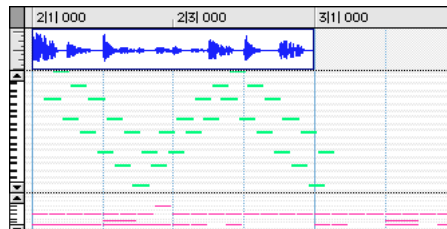

Edit window with grid lines

You can also enable and disable grid lines by Control-clicking (Macintosh) or Alt-clicking the Indicator Dot for any Timebase Ruler.

Control-click (Macintosh) or  
Alt-click (Windows) for Grid lines

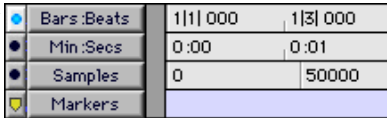

Bars:Beats	1 1  000	1 3  000
Min:Secs	0:00	0:01
Samples	0	50000
Markers		

Turning on grid lines from Ruler

---

## Zooming

Zooming options in Pro Tools include the Horizontal and Vertical Zoom buttons, the Zoomer tool, and the Zoom Preset buttons.

### Horizontal and Vertical Zoom Buttons

Use the Horizontal and Vertical Zoom buttons to zoom in and out on track data. Unlike the horizontal zoom value, the vertical zoom value for MIDI and audio tracks are independent, and therefore have separate buttons.

**To zoom in horizontally for all tracks:**



*Horizontal Zoom button*

- Click the right Horizontal Zoom button. To zoom out, click the other (left) Horizontal Zoom button.

– or –

Press Command+] (Macintosh) or Control+] (Windows). To zoom out, press Command+[ (Macintosh) or Control+[ (Windows).

**To zoom in vertically for all audio tracks:**



*Vertical Zoom button (audio)*

- Click the (top) Vertical Zoom button with the audio waveform. To zoom out, click the bottom Vertical Zoom button.  
– or –

Press Command+Option+] (Macintosh) or Control+Alt+] (Windows). To zoom out, press Command+Option+[ (Macintosh) or Control+Alt+[ (Windows).

**To zoom in vertically for all MIDI tracks:**



*Vertical Zoom button (MIDI)*

- Click the (top) Vertical Zoom button with the MIDI notes. To zoom out, click the bottom Vertical Zoom button.  
– or –

Press Command+Shift+] (Macintosh) or Control+Shift+] (Windows). To zoom out, press Command+Shift+[ (Macintosh) or Control+Shift+[ (Windows).

### To return to the previous zoom level:

- Option-click (Macintosh) or Alt-click (Windows) any of the Horizontal or Vertical Zoom buttons.

– or –

Press Command+Option+E (Macintosh) or Control+Alt+E (Windows).

### To zoom in on a selection:

- Press Option+F (Macintosh) or Alt+F (Windows).

### To zoom so that all regions are visible and fill the Edit window:

- Double-click the Zoomer tool in the toolbar.

– or –

Press Option+A (Macintosh) or Alt+A (Windows).

## Zoomer Tool

Use the Zoomer tool to zoom in and out around a particular area within a track.

### To zoom around a certain track point:

- 1 Select the Zoomer tool.



*Zoomer tool*

- 2 Click once with the Zoomer at the point within the track. All tracks are zoomed in by one level and the Edit window is centered around the zoomed point.

- 3 To zoom back to the previous level, Option-click (Macintosh) or Alt-click (Window) with the Zoomer.

### To zoom into a particular track area:

- 1 Select the Zoomer tool.

- 2 To zoom horizontally, drag with the Zoomer in the track's playlist.

– or –

To zoom horizontally *and* vertically, press Command (Macintosh) or Alt (Windows) while dragging in the track's playlist.

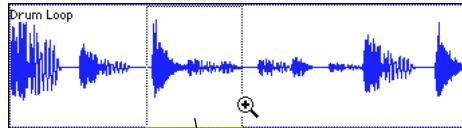

*Zooming horizontally with Zoomer tool*

The zoomed area fills the entire Edit window.

## Zooming in the Ruler

### To zoom horizontally in the Ruler:

- 1 Press Command+Control (Macintosh) or Control+Alt (Windows) and move the cursor into the Ruler area, so the Zoomer appears.

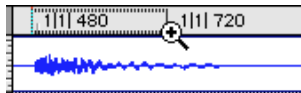

*Zooming in the Ruler*

- 2 Click once to zoom in one level around a certain point.

– or –

Drag to zoom in around a particular Ruler range.



## Zoom Preset Buttons

Pro Tools allows you to save up to 5 horizontal zoom presets, which can be recalled by typing a number or by clicking a Zoom Preset button.

### To store a zoom preset:

- 1 Using either the Horizontal Zoom buttons or the Zoomer tool, navigate to the zoom level you want to store.
- 2 While pressing Command (Macintosh) or Control (Windows), click one of the five Zoom Preset buttons.



### Storing a zoom preset

The button flashes, indicating it is being written to, and then becomes selected.

### To recall a zoom preset:

- Click the Zoom Preset button.
  - or –
- With the Commands Key Focus enabled (TDM Systems only), type the Zoom Preset's number on the alpha keyboard.
  - or –
- While pressing Control (TDM Systems only), type the Zoom Preset's number on the alpha keyboard.

Horizontal zoom levels for all tracks are recalled.

\* Zoom settings can also be stored with Memory Locations. For details, see “Memory Locations and Markers” on page 235.

## Rulers

Any or all of the following Timebase Rulers can be displayed at the top of the Edit window:

- Bars:Beats
- Minutes:Seconds
- Time Code (TDM systems only)
- Feet:Frames
- Samples

In addition to providing a timing reference for track material, the Timebase Rulers are also used to define *Edit selections* for track material, and *Timeline selections* for record and play ranges.

\* With the Selector, drag in any Timebase Ruler to select material across all tracks in the Edit window. To include the Conductor Tracks in the selection, press Option (Macintosh) or Alt (Windows) while dragging.

Bars:Beats	1	2	3	4	5	6	7
Min:Secs	0:00			0:05			0:10
Time Code	00:00:00:00			00:00:05:00			00:00:10:00
Feet:Frames	0+00	5+00		10+00			15+00
Samples	0			200000			400000
Tempo	Default: 120.00						
Meter	Default: 4/4						
Markers							

### All Rulers displayed

Any or all of the following Conductor Rulers can be displayed:

- Tempo
- Meter
- Markers

The Meter and Tempo Rulers indicate changes in meter and tempo within the Session. The Markers Ruler displays Markers to important track locations.

### To display all Rulers:

- Select Display > Ruler View Shows > All.

### To remove a Ruler from the display:

- Option-click the Ruler's name (to the left of the Ruler display).
  - or –
- Deselect the Ruler in Display > Ruler View Shows.

### To display only the Main Time Scale in the Ruler:

- Select Display > Ruler View Shows > None.

### To add a specific Ruler to the display, such as the Markers Ruler, for instance:

- Select Display > Ruler View Shows > Markers.

### To change the display order for the Rulers:

- Click on a Ruler's name and drag up or down to the new location.

## Ruler Options Pop-up Menu

The Ruler display options are also available from a pop-up menu that is accessed by clicking just to the right of the Ruler names.

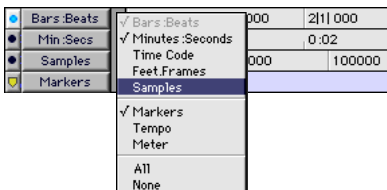

Ruler Options pop-up menu

## Time Scale

While all Timebase Rulers can simultaneously be displayed in the Edit window, there is only one that represents the *Main Time Scale*. The Main Time Scale determines the time format used for:

- The Transport's Main Counter
- Start, end, and length values
- Pre and post-roll amounts
- Grid and Nudge Values

The Main Time Scale can be set to the following formats:

**Bars:Beats** Displays the Time Scale in bars and beats. Use the this Time Scale if you are working with musical material that must align with bars and beats.

To ensure your tracks align with the bars and beats in your session, make sure to record with the click (see "Recording with the Click" on page 83).

Material that is recorded without listening to the click can still be aligned to bar and beat boundaries in Pro Tools with the Identify Beat command (see "Identify Beat Command" on page 230).

**Minutes:Seconds** Displays the Time Scale in minutes and seconds. As you zoom in farther with the Zoomer, the Time Scale begins to display tenths, hundredths, and thousandths of a second.

**Time Code** Displays the Time Scale in SMPTE frames. The Frame Rate and Session Start time are set from the Session Setup window. Pro Tools supports the following frame rates: 24, 25, 29.97 Non-Drop, 29.97 Drop, 30 Non-Drop, and 30 Drop frames per second.

**Feet.Frames** Displays the Time Scale in feet and frames for referencing audio-for-film projects. The Feet.Frames time display is based on the 35 millimeter film format.

With this Time Scale, you can enter a Start Frame based on an appropriate frame location at the beginning of your project tape. The Feet.Frames Ruler will then use this value as its start reference.

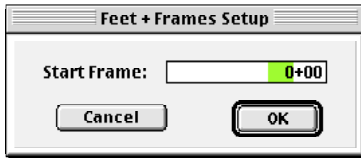

The Feet.Frames dialog

**To set a start frame for a session:**

- Choose Setups > Feet.Frames and enter an appropriate start frame and click OK (negative offsets are not supported). This value will become the “zero point” in the Feet.Frames Ruler.

**Samples** Displays the Time Scale in samples. This format is very useful for high-precision sample editing.

**Setting the Main Time Scale**

**To set the Main Time Scale:**

- Select the desired Time Scale at the bottom of the Display menu.
- or –

Select from the Main Time Scale pop-up next to the Location Indicator (also available in the Transport window).



Main Time Scale pop-up

– or –

If a Timebase Ruler is displayed, click its Indicator Dot so it becomes highlighted.

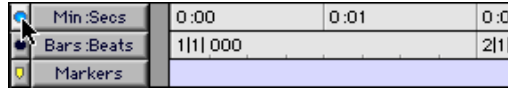

Switching the Main Time Scale in the Ruler

**Setting the Sub Time Scale**

There is also a *Sub Location Indicator* displayed below the Main Location Indicator, and below the Transport’s Main Counter, which provides an additional timing reference.

**To set the Time Scale for the Sub Location Indicator:**

- Select from the Sub Time Scale pop-up next to the Location Indicator
- or –

Select from the Sub Time Scale pop-up in the Transport Window.

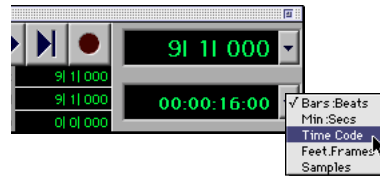

Sub Time Scale pop-up (Transport window)

\* While you can click in the Main Counter and type in a location to automatically locate there, this is not supported for the Sub Counter.

---

## Tick-Based Timing

Pro Tools is a sample-based program with an internal resolution of 960,000 pulses per quarter note (ppq). However, when the Time Scale is set to Bars:Beats, the display resolution in Pro Tools is 960 ppq.

In Bars:Beats, Pro Tools is tick-based (960 ticks to a quarter note), which means that some amount of sample-rounding may occur when placing events at certain locations (see “Sample-Rounding and Edit Operations” on page 152).

When working in Bars:Beats, you’ll often want to specify tick values for a number of operations, including:

- Placing and spotting regions
- Setting lengths for regions or MIDI notes
- Locating and setting play and record ranges (including pre/post-roll)
- Specifying parameters in the Quantize and Change Duration windows
- Setting the Grid and Nudge values

The following table lists the number of ticks for each of the main note sizes:

note value	normal	dotted	triplet
1/2 note	1920	2880	1280
1/4 note	960	1440	640
1/8 note	480	720	320
1/16 note	240	360	160
1/32 note	120	180	80
1/64 note	60	90	40

## Ticks vs. Samples

Audio material in Pro Tools is sample-based. This means that if an audio region is located at a particular sample (or SMPTE) location, it will not move from this location if the tempo changes in the session (though the audio region’s bar and beat location will change).

MIDI data in Pro Tools is bar- and beat-based. This means that if a MIDI region is located at a particular bar and beat location, it will not move from that location if the tempo changes in the session—though its sample location will change, thereby adjusting its relationship to audio.

When creating Markers and Selection Memory Locations, you can specify whether they have an Absolute (sample-based) or Bar|Beat (tick-based) reference. For more information, see “Bar|Beat and Absolute Reference” on page 236.

## Sample-Rounding and Edit Operations

Because audio material in Pro Tools is sample-based, some amount of sample-rounding may occur with some edits when the Main Time Scale is set to Bars:Beats. This is most evident when you need audio regions to fall cleanly on the beat (as when looping) and notice that the material is sometimes a tick or two off. With a few simple precautions, this can be avoided.

When selecting audio regions to be copied, duplicated, or repeated, make sure to select the material with the Selector (enable Grid Mode for precise selections), or set the selection range by typing in the start and end points in the Event Edit area. Do not select the material with the Grabber (or by double-clicking with the Selector). This ensures that the selection will be precise in terms of bars and beats (and not based on the length of the material in samples).



## chapter 14

# Playing/Selecting Track Material

## Playing Tracks

After recording or importing to tracks, you'll want to listen to the material to find track ranges that require editing, or material that can be turned into regions for use elsewhere.

You can click anywhere in a track with the Selector to begin playback from that point (as long as the Edit and Timeline selections are linked, see “Separate Edit and Timeline Selections” on page 161).

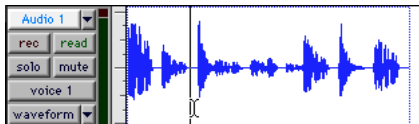

Setting a playback point with the Selector

Depending on the selected Scrolling Option, the *playback cursor*, a solid unblinking line, moves across the Edit window to indicate the current playback position. The playback location is displayed in the Counters in the Transport window, in the Big Time window, and also in the Location Indicators.



Transport with Counters displayed

The *edit cursor*, on the other hand, is a flashing line that appears when you click with the Selector in a track's playlist. The blinking edit cursor indicates the start point for any editing tasks performed. If you make a selection and perform an edit, the selection is the target of the edit.

The selected Scrolling Option determines how the Edit window scrolls during playback, and how the playback cursor functions. See “Scrolling Options” on page 157 for details.

### To begin playing from a specific point within a track:

- 1 Select Operations > Scrolling Options > No Auto Scrolling.
- 2 Make sure to select Operations > Link Edit and Timeline Selection.
- 3 With the Selector, click in the track where you want playback to begin.
- 4 Click Play in the Transport window to begin playback.
- 5 Click Stop in the Transport window to stop playback.

To jump to a different location and begin playing from there, click with the Selector at that point and click Play in the Transport window.

---

\* With the Edit and Timeline selections linked, you can click on a region or MIDI note with the Grabber to automatically update the Timeline with the selection's start time, allowing you to easily play from that point.

---

### Page Scroll During Playback

You can set Pro Tools to scroll the track display while playing, and have the edit cursor appear wherever playback stops.

#### To make the track display and the edit cursor follow playback:

- 1 Select Operations > Scrolling Options > Page Scroll During Playback.
- 2 Choose Setups > Preferences. In the Operation page of the Preferences dialog, select the option for "Timeline Insertion Follows Playback," then click Done.
- 3 Make sure to select Operations > Link Edit and Timeline Selection.
- 4 With the Selector, click in the track where you want playback to begin.
- 5 Click Play in the Transport window to begin playback. The playback cursor scrolls across the Edit window, indicating the current playback position.
- 6 Click Stop in the Transport window to stop playback. The edit cursor appears at the location where playback stops.

### Locating and Auditioning with Fast Forward/Rewind

You can use the Fast Forward and Rewind buttons in the Transport window to locate material in your tracks. If the Operation Preference for "Audio During Fast Forward/Rewind" is selected, you'll actually hear the scanned audio (similar to a CD player) when clicking the Fast Forward and Rewind buttons.

You can also fast forward or rewind incrementally by repeatedly clicking the appropriate button. The size of these increments is determined by the Main Time Scale:

- Bars:Beats: moves to the beginning of the previous or next bar
- Min:Sec: moves back or forward in one-second steps
- Time Code: moves back or forward in one-second steps (while adjusting for current SMPTE format)
- Feet.Frames: moves back or forward in one-foot steps
- Samples: moves back or forward in one-second steps

### Location Indicators

The Location Indicators, in the upper right of the Edit window, display the current playback location, and also provide a convenient way to navigate to a specific time location.



Location Indicators (Main and Sub)

The Main Location Indicator displays the playback location in the time format for the Main Time Scale. The Sub Location In-



indicator can be set to any of the other Time Scale formats for another timing reference. Both the Main and Sub indicators also appear in the Transport window when it is set to display Counters.

#### To navigate with the Location Indicators:

- 1 Click in one of the Location Indicators.  
– or –

Press Equal (=) on the numeric keypad to highlight the Main Location Indicator (or the Transport Counters or Big Time window, if either are displayed).

- 2 Type in the new location. Press period (.) to cycle through to the different time fields.

- 3 Press Enter to accept the new value and automatically locate there.

---

\* Choose from the pop-up menus next to the Main and Sub indicators (in either the Edit window or Transport window) to set their time formats.

---

#### Scrolling in the Ruler

You can scroll the contents of the Edit window by clicking and dragging in the Ruler. While this doesn't actually update the session's Current Location, it does let you conveniently shift the display left or right for the sake of finding and editing material.

This method of scrolling is especially useful when using Continuous Scroll with Playhead (TDM systems only), which does not update or follow Timeline selections.

#### To scroll the entire contents of the Edit window from the Ruler:

- While pressing Command+Option+Control (Macintosh) or Control+Alt+Start (Windows), drag left or right in any of the Timebase Rulers.

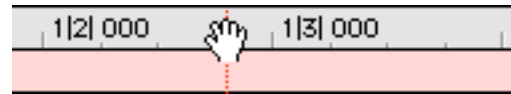

*Scrolling in the Ruler*

---

## Scrolling Options

Pro Tools offers the following options for how it scrolls the contents of the Edit window during playback and recording.

Choose Operations > Scrolling Options and select one of the following from the sub-menu:

**No Auto-Scrolling** With this scrolling option, the Edit window does not scroll during or after playback. The playback cursor moves across the Edit window, indicating the playback location.

**Scroll After Playback** Causes the Edit window to scroll to the final playback location after playback has stopped. In this mode, the playback cursor moves across the Edit window, indicating the playback location.

**Page Scroll During Playback** Causes the Edit window to scroll during playback. With this option, the playback cursor moves across the Edit window, indicating the playback location. When the right edge of the Edit window is reached, its entire contents are scrolled, and the playback cursor continues moving from the left edge of the window.

## Continuous Scroll During Playback

### (TDM Systems Only)

This scrolling option causes the Edit window's contents to scroll continuously past the playback cursor, which remains in the center of the window. With this option, playback is always based on the Timeline selection (unlike Continuous Scroll With Playhead).

## Continuous Scroll With Playhead

### (TDM Systems Only)

This scrolling option causes the Edit window's contents to scroll continuously past the *Playhead*, which is a blue line in the center of the window (red when recording).

The Playhead always indicates where playback begins when clicking Play in the Transport window. The Playhead is completely independent of the Timeline selection; if the Timeline selection changes, the Playhead will not update its location when playback is initiated from the Transport. When recording, however, the Playhead always jumps to the Timeline selection.

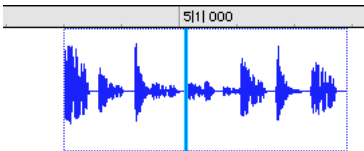

*Continuous Scroll with Playhead*

To move the Playhead to a particular location for playback, scroll there in the Ruler (see “Scrolling in the Ruler” on page 157), use the Edit window's horizontal scroll bar, or type the location into one of the Location Indicators or one of the Counters.

With the Playhead enabled, you can still jump to and play an Edit or Timeline selection. For details, see “Playing Edit and Timeline Selections with the Playhead” on page 173.

## Half-Screen Edit Window

When either Continuous Scroll During Playback or Continuous Scroll with Playhead is enabled, a half-screen appears at the far left of the Edit window (before the beginning of the session).

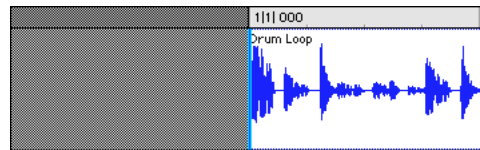

*Half-screen for Continuous Scroll with Playhead*

---

## The Scrubber

The Scrubber allows you to “scrub” up to two tracks of audio in the Edit Window. Scrubbing is a technique that originated in tape editing, where the tape was rocked back and forth past the playhead at slower than normal speeds to find a particular location (usually for the sake of performing splices).

While viewing an audio waveform in Pro Tools can be helpful in visually finding an edit point, sometimes a waveform (because of its sonic characteristics) may not reveal the desired spot in the audio material. By scrubbing back and forth over an edit point in Pro Tools, you can zero in on the exact edit point you're looking for.

When the Operation Preference for “Edit Insertion Follows Scrub/Shuttle” is enabled, the edit cursor automatically locates to the point where scrubbing stops.

When the Scrolling Option is set to Continuous Scroll During Playback or Continuous Scroll with Playhead, clicking with the Scrubber in a track’s playlist centers the Edit window around that point, and moves the Playhead there. With these Scrolling Options, scrubbed material moves past the Playhead, which remains stationary and centered.

▲ Scrubbing is only supported for audio tracks. MIDI tracks cannot be scrubbed.

### To scrub a single audio track:

1 With the Scrubber selected, drag within the track—left for reverse, right for forward.

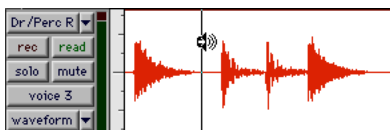

*Scrubbing an audio track with the Scrubber*

The distance and speed with which you drag (with either the mouse, or an external MIDI controller wheel) determine the length and speed of the scrubbed audio. Audio from the scrubbed track is routed to its output, along with any effects assigned to the track.

The resolution for the Scrubber is dependent upon the zoom factor for the scrubbed track. For finer resolutions without zooming, press Command (Macintosh) or Control (Windows) while scrubbing.

\* You can temporarily switch the Selector to the Scrubber by Control-clicking (Macintosh) or Right-clicking (Windows). For finer resolution, Command-Control-click (Macintosh) or Control-Right-click (Windows).

### To scrub up to two audio tracks:

■ With the Scrubber selected, drag between two adjacent tracks.

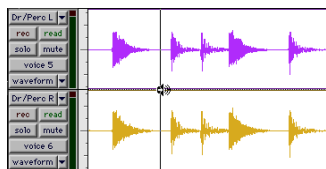

*Scrubbing between two audio tracks*

– OR –

Scrub within a selection that contains multiple tracks. Only the first two tracks, however, are heard.

### Scrub/Shuttle Mode

When scrubbing normally, you can scrub at normal playback speeds or slower. Scrub/Shuttle mode, however, lets you scrub at several times normal speed, which is helpful in playing through large ranges and locating material.

### To scrub in Shuttle mode (at several times normal speed):

1 Select the Scrubber tool.  
2 While pressing Option (Macintosh) or Alt (Windows), drag within the track—left for reverse, right for forward. The Fast Forward and Rewind buttons in the Transport window engage.

The distance and speed dragged determine the speed for the scrubbed audio.

## Shuttle Lock Mode

Shuttle Lock mode lets you trigger playback for up to two tracks at varying speeds, forward and reverse, from the numeric keypad. If multiple tracks are selected, only the first two tracks are shuttled.

### To play a track with the shuttle lock:

- 1 For TDM systems, make sure the Operation Preference for Numeric Keypad Mode is not set to Shuttle.
  - 2 With the Selector, click in the track where you want playback to begin. To shuttle on two tracks, Shift-click in a second track.
  - 3 Press Control (Macintosh) or the Start key (Windows) and a number on the numeric keypad: 0–9 (9 is fastest, 5 is normal speed, and 0 stops shuttling).
- Once Shuttle Lock mode is initiated, Fast Forward and Rewind become highlighted in the Transport window.
- 4 Press additional keys to change the playback speed, or press Plus (+) and Minus (-) to switch the playback direction (plus for forward, minus for backward).
  - 5 To stop playback, press Control+0 (Macintosh) or Start+0 (Windows).
  - 6 To exit Shuttle Lock mode, press Stop in the Transport window.

## Numeric Keypad Set to Shuttle

### (TDM Systems Only)

Pro Tools offers another form of shuttling, different from that of Shuttle Lock Mode. With the Numeric Keypad Mode set to Shuttle, playback is triggered by pressing and holding the keys on the numeric keypad—playback stops once the keys are released. Various playback speeds are available in both forward and reverse.

### To shuttle with the Numeric Keypad Mode set to Shuttle:

- 1 Choose Setups > Preferences and click Operations.
- 2 Set the Numeric Keypad Mode to Shuttle and click Done.
- 3 With the Selector, click in the track where you want playback to begin. To shuttle on two tracks, Shift-click in a second track.
- 4 Press and hold any of the following keys (or key combinations) on the numeric keypad to trigger playback.

Shuttle Speed	Rewind Key	Forward Key
1 X Speed	4	6
4 X Speed	7	9
1/4 X Speed	1	3
1/2 X Speed	4+5	5+6
2 X Speed	7+8	8+9

- 5 Press a different key to switch the playback direction or speed. Release to stop.

## Separate Edit and Timeline Selections

Pro Tools lets you unlink the Edit and Timeline selections. In doing so, you can make a selection within a track for editing purposes that is distinct from the selection in the Timeline (which determines the playback and recording range).

By default, the Edit and Timeline selections are linked. In this mode, selecting in a track's playlist (an Edit selection) also defines the play and record range (the Timeline selection).

### To unlink the Edit and Timeline selections:

- Deselect Operations > Link Edit and Timeline Selection.  
– or –

In the upper left of the Edit window, click the Linked Selections button so it becomes unhighlighted.



*Linked Selections button, disabled*

If you are working with a film or video scene, you may want to unlink the Edit and Timeline selections to work with material that is at a different location than the current play range. The scene you're working with (defined by the Timeline selection) may require some sound effects and you can go to another location in the session to find and audition them. Edit selections can be played (choose Operations > Play Edit Selection) without disrupting the current Timeline selection. Once the desired mate-

rial is found, you can then go back to the Timeline selection and place them within the context of the scene.

Figure 10 illustrates another reason you'd want to unlink the Edit and Timeline selections. In this example, the Timeline selection sets a range to be looped on playback, while a MIDI region (residing within the loop) is selected for editing purposes. During playback, the Edit selection can be nudged, quantized, or transposed while the loop plays back completely independent and uninterrupted.

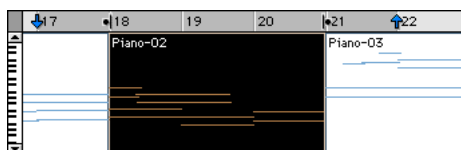

**Figure 10.** Edit and Timeline selections unlinked

While you could theoretically do this with the Edit and Timeline selections linked, as soon as playback is stopped, the playback range would then be updated to that of the more recent edit range.

## Playback/Edit Markers

Timeline selections are displayed in the Ruler with *Playback Markers*, which appear as blue arrows (red when recording). In addition, there are *Pre- and Post-Roll Flags* (which are green when enabled) indicating the location for pre/post-roll.



*Playback Markers with Pre/Post-Roll Flags*



**Figure 11.** Edit Markers

When the Edit and Timeline selections are unlinked, Edit selections are displayed in the Ruler with *Edit Markers*, which appear as black brackets. If the Edit and Timeline selections are linked, Edit selections are represented by the blue Playback Markers.

See the following sections for details on working with Edit and Timeline selections:

- “Selecting Track Material” on page 162
- “Timeline Selections” on page 171
- “Setting Punch/Loop Points” on page 96
- “Setting Pre/Post-Roll” on page 97

---

## Selecting Track Material

Before audio and MIDI material can be edited, it must first be selected. A track’s Display Format determines how the material is viewed and selected.

When you make a selection, it appears as a highlighted area of the track, and is also indicated by blue start and end arrows (*Playback Markers*) in the Ruler at the top of the Edit window. If any track (audio or MIDI) in the session is record-enabled, even if it is hidden, these markers appear red.



*Playback Markers indicating Edit selection*

☞ If the Edit and Timeline selections are unlinked, the Edit selection range is indicated by Edit Markers in the Ruler. See “Separate Edit and Timeline Selections” on page 161 for details.

---

## Selections and Edit Groups

When making selections on tracks that are part of an Edit Group, all other tracks within the group also become selected. This is especially useful when working with stereo pairs.

## Selections and Hidden Tracks

When editing tracks that are part of an active Edit Group, any tracks within the group that are hidden are not affected by the edits. To edit all members of a group, make sure they are visible by highlighting their names in the Show/Hide Tracks list.

## Selecting Regions

### To select a portion of a region:

- 1 With the Selector, drag within the region (left or right) to select the material.

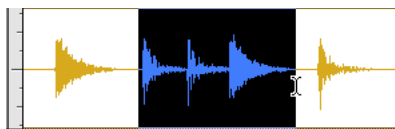

*Selecting a portion of a region*

### To select an entire (single) region:

- Click on the region with the Grabber.  
– or –

Double-click the region with the Selector.

### To select two regions (and the time range between them):

- 1 With the Grabber, click on the first region.
- 2 Shift-click on the second the region. Both regions become selected, along with the time range between them (including any other regions).

### **To select an entire track:**

- Click in the track with the Selector and then choose Edit > Select All.
  - or –

Triple-click in the track with the Selector.

### **To select all regions in all tracks:**

- 1 Select the “All” Edit Group in the Groups List.
- 2 Click in any track with the Selector and choose Edit > Select All.
  - or –

Triple-click with the Selector in any track.

### **Selecting All from Timebase Rulers**

You can select all regions in all tracks displayed in the Edit window by double-clicking in any Timebase Ruler.

#### **To select all material in all displayed audio and MIDI tracks:**

- 1 Make sure the Edit and Timeline selections are linked.
- 2 Double-click in any Timebase Ruler. All regions in all displayed audio and MIDI tracks are selected. Tracks that are hidden are not selected.

#### **To select all material in all tracks, along with Conductor events:**

- 1 Make sure the Edit and Timeline selections are linked.
- 2 While pressing Option (Macintosh) or Control (Windows), double-click in any Timebase Ruler. All regions in all displayed audio and MIDI tracks are selected, along with all events in each of the Conductor tracks.

### **Making Selections While Playing**

Pro Tools lets you make on-the-fly selections with the Arrow keys.

#### **To make a selection while playing:**

- 1 Make sure to select Operations > Link Edit and Timeline selection.
- 2 With the Selector, click somewhere near the beginning of the track in which you want to make the selection.
- 3 Click Play in the Transport window to begin playback.
- 4 When playback reaches the point where you want the selection to begin, press the Down Arrow key.
- 5 Press the Up Arrow key at the point where you want the selection to end. The selected range becomes highlighted.
- 6 To stop playback, click Stop in the Transport window.

To automatically scroll to the beginning of the selection (or to the location of the on-screen cursor), press the Left Arrow key. To scroll to the end of the selection, press the Right Arrow key.

### **Object Selections**

#### **(TDM Systems Only)**

You can use the Object Grabber to select discontinuous regions on one or more tracks. Discontinuous selections must encompass entire regions. If you want a discontinuous selection to include a portion of a region, first use the Separation Grabber to turn the region portion into a region (see “Separation Grabber” on page 176).

---

▲ The Object Grabber is not available when the Edit mode is set to Shuffle or Spot.

---

### To select discontinuous regions:

- 1 Make sure the Edit mode is set to either Slip or Grid.
- 2 Choose the Object Grabber from the Grabber tool pop-up menu.



*Object Grabber*

- 3 Shift-click each region you want to include in the selection. The regions can even reside on different tracks.

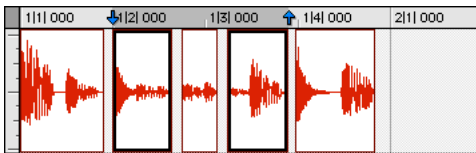

*Discontiguous selection*

Each clicked region becomes surrounded by a dark rectangle, indicating it is selected.

The Object Grabber ignores Edit Groups when making selections. For instance, selecting a region on a grouped track does not cause regions in the other tracks in the group to become selected.

### Object to Time Selection (TDM Systems Only)

You can convert between Time- and Object-based selections. Time selections are made with the Selector and Time Grabber. Object selections are made with the Object Grabber.

Converting to an Object selection is useful when working with large selections, especially across multiple tracks, and want to remove certain regions from the selection.

Converting to a Time selection is useful if you want to select all regions between a discontinuous Object selection.

### To change a Time selection to an Object selection:

- 1 Drag with the Selector in any track to define a selection. Select in a Timebase Ruler to select across all tracks.

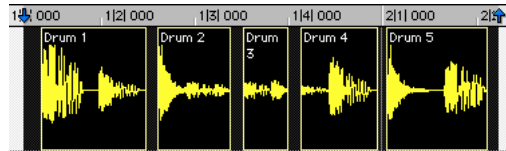

- 2 With the Object Grabber selected, double-click the Grabber icon in the toolbar. The regions falling within the selection range become selected as objects. Regions that were partially selected become deselected.

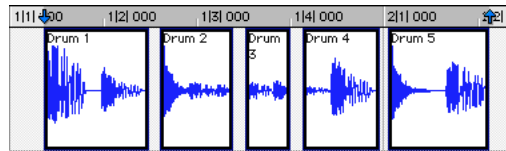

- 
- \* To select regions that were partially selected, press the Control key while double-clicking the Grabber icon.
-



### To change an Object selection to a Time selection:

- 1 Select any number of regions with the Object Grabber.
- 2 Double-click the Selector icon in the toolbar. The time range between the first and last region becomes selected.

If using the Object Grabber (TDM systems only), regions on the other tracks in the group are selected if they fall within the range of the selected region.

### Changing a Selection Length

You can make an existing selection longer or shorter by pressing the Shift key while clicking or dragging, or by dragging the Playback Markers in the Ruler.

#### To change the length of a selection:

- With the Selector, position the cursor over one end of the current selection and Shift-click or Shift-drag left or right.
  - or –

In the Ruler, drag the Playback Marker for the selection's start or end point.

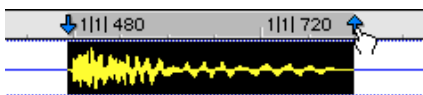

*Dragging a Playback Marker*

– or –

If the Edit and Timeline selections are unlinked, drag the Edit Markers (see Figure 11 on page 161) to change the selection length.

### To quickly make a lengthy selection:

- 1 With the Selector, click at the beginning of the selection.
- 2 Scroll to the end point of the selection and Shift-click at that point.

To verify the start and end points of a long selection, press the Left Arrow key to scroll to the beginning of the selection, or press the Right Arrow key to scroll to the end.

### Nudging a Selection Range

The selection range (not the material within the selection) can be moved by the Nudge value.

#### To nudge a selection range:

- 1 Configure the Nudge value as desired. For details, see “Defining the Nudge Value” on page 187.
- 2 Make the initial selection with the Selector.
- 3 While pressing Shift, press Plus or Minus on the numeric keypad to move the selection range by the Nudge value.

### Nudging Selection Start/End Points

Start and end points for selections can be moved by the nudging them.

#### To move a selection start or end point by the Nudge value:

- 1 Configure the Nudge value as desired. For details, see “Defining the Nudge Value” on page 187.
- 2 Make the initial selection with the Selector.

**3** While pressing Option+Shift (Macintosh) or Alt+Shift (Windows), press Plus or Minus on the numeric keypad to move the selection's start point by the Nudge value.

– or –

While pressing Command+Shift (Macintosh) or Control+Shift (Windows), press Plus or Minus on the numeric keypad to move the selection's end point by the Nudge value.

## Extending Selections

You can extend selections to region start and end points, to include an adjacent region, or to Markers and Memory Locations.

**To extend a selection to a region start or end point:**

**1** With the Selector, select a portion of a region, or click anywhere in the region.

**2** Press Shift+Tab to extend the selection to the region's end point.

– or –

Press Shift+Option+Tab (Macintosh) or Shift+Control+Tab (Windows) to extend the selection to the region's start point.

**To extend a selection to include an adjacent region:**

**1** Select the first region with the Grabber.

**2** Press Shift+Control+Tab (Macintosh) or Shift+Start+Tab (Windows) to extend the selection to include the next region.

– or –

Press Shift+Control+Option+Tab (Macintosh) or Shift+Start+Control+Tab (Windows) to extend the selection to include the previous region.

**To extend a selection to a Marker or Memory Location:**

**1** Click in a track with the Selector at the selection's start or end point.

– or –

Make a selection with the Selector or Grabber.

**2** Shift-click a Marker in the Markers Ruler (or in the Memory Locations window).

– or –

Shift-click a Memory Location in the Memory Locations window.

The selection is extended from the original Insertion point to the Marker or Memory Location.

## Using the Selection Indicators to Make a Selection

The Selection Indicators at the top of the Edit window allow you to make precise selections. Time values for the Selection Indicators use the time format for the Main Time Scale.

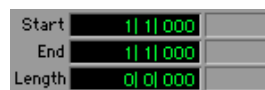

*Selection Indicators*

**To make a selection with the Selection Indicators:**

**1** Click with the Selector in the track you want to select.

**2** Click in the Start field at the top of the Edit window.

– or –

Press the slash key to select the Start field.

**3** Type in the start point for the selection and press the slash key to enter the value and automatically move to the end field.

**4** Type in the end point for the selection and press Enter to accept the value.

### **Numeric Entry Shortcuts for Selection Indicators**

Following is a list of relevant keyboard shortcuts for entering values in the Selection Indicators:

- Press the slash key to cycle through the three Selection Indicators.
- Use period (.) or the Left/Right Arrow keys to move through the different time fields in each Selection Indicator.
- Use the Up/Down Arrow keys to increase or decrease the numerical values.
- Press Plus (+) or Minus (-) along with an accompanying number to add or subtract from the current field value.

For example, to add 10 to a current field value, cycle to the field, press the Plus key, type “10” and then press Enter.

When using this calculator function with the Time Scale set to Bars:Beats, it is not possible to use Minus (-) to subtract from a value (this allows the possibility of entering negative bar numbers).

- Press Escape to exit the Selection Indicators without entering any values.

### **Calculator Entry Mode and Bars:Beats**

#### **To use Minus in Calculator mode with the Time Scale set to Bars:Beats:**

- 1** Highlight the time field you want to change.
- 2** While pressing Command (Macintosh) or Control (Windows), press Minus on the numeric keypad.
- 3** Type the amount you want to subtract from the current time value, then press Enter.

### **Making a Selection Across Multiple Tracks**

To perform edits across multiple tracks or all tracks, you must first select the tracks. Do this by making selections on tracks that are grouped (see “Grouping Tracks” on page 62), by extending selections to other tracks, or by selecting in a Timebase Ruler (for all tracks).

#### **To extend a selection to another track:**

- 1** Using the Selector or Grabber, make a selection in the first track.
- 2** Shift-click in additional tracks with the Selector. An identical range is selected for each additional track.

To shorten or extend the selection across each of the tracks, press Shift while dragging to change the range of the selection.

**To select data on All tracks at the same time:**

■ With the Selector, Option-Shift-drag (Macintosh) or Alt-Shift-drag (Windows) in any track.

– or –

Enable the *All* Edit Group and make a selection in any track.

– or –

Drag with the Selector in any Timebase Ruler (make sure the Edit and Timeline Selections are linked).

These selections include all tracks in the Edit window, but do not include the Conductor Tracks (for Tempo, Meter, and Markers).

**To select data on all tracks, including the Conductor tracks:**

■ While pressing Option (Macintosh) or Alt (Windows), drag with the Selector in any Timebase Ruler.

**Moving/Extending Selections between Tracks**

**(TDM Systems Only)**

With the Commands Key focus enabled (TDM systems only), Edit selections can be moved or extended to adjacent tracks.

**To move a selection to an adjacent track:**

1 Enable the Commands Key focus by clicking its button in the upper left of the Edit window.



*Commands Key button, enabled*

2 With the Selector or Grabber, make a track selection.

3 Press P on your computer keyboard to move the selection to the previous track.

– or –

Press semicolon to move the selection to the next track.

In either instance, the original Edit selection becomes deselected.

**To extend a selection to an adjacent track:**

1 Enable the Commands Key focus.

2 With the Selector or Grabber, make a track selection.

3 Press Shift+P to extend the selection to the previous track.

– or –

Press Shift+semicolon to extend the selection to the next track.

In either instance, the original Edit selection remains selected.

**To remove a track from a selection:**

■ Press Option+P (Macintosh) or Alt+P (Windows) to remove the uppermost track.

– or –

Press Option+semicolon (Macintosh) or Alt+semicolon (Windows) to remove the lowermost track.

## Other Useful Selection Techniques

In time you will discover your favorite selection techniques. Here are a few to get you started:

### To position the edit cursor precisely at a region start, end, or sync point:

- 1 Click with the Selector in the track.
- 2 Press Tab to move the cursor to the next region start, end, or sync point.
  - or –

Press Option+Tab (Macintosh) or Control+Tab (Windows) to move the cursor to the previous region start, end, or sync point.

### To make a selection with the Scrubber:

- 1 Scrub with the Scrubber to find an appropriate start point for the selection, then release.
- 2 Shift-Scrub to an appropriate end point for the selection, then release. The range between the initial and final scrub becomes selected.

### To move a selection to an adjacent region on the same track:

- 1 Select a region with the Grabber.
- 2 Press Control+Tab (Macintosh) or Start+Tab (Windows) to move the selection to the next region.
  - or –

Press Control+Option+Tab (Macintosh) or Start+Control+Tab (Windows) to move the selection to the previous region.

In either instance, the original region becomes deselected.

### To slide an Edit selection in the Ruler:

- 1 With the Selector or Grabber, make a track selection.
- 2 While pressing Option (Macintosh) or Alt (Windows), move the cursor over either of the Playback Markers in the Ruler (the Grabber appears).



*Sliding an Edit selection in the Ruler*

- 3 Drag left or right to move the Edit selection back or forward in time, while preserving its length.

---

\* If the Edit and Timeline selections are unlinked, Option-drag (Macintosh) or Alt-drag (Windows) the Edit Markers instead.

---

## Region List Selection Follows Track Selection

When the Editing Preference for “Region List Selection Follows Track Selection” is enabled, selecting a region in a track also causes the region to become selected in the Audio or MIDI Regions List.

Conversely, if the Editing Preference for “Track Selection Follows Region List Selection” is enabled, selecting a region in the Audio or MIDI Regions List causes the initial occurrence of that region to become selected within the track.

---

## Playing Selections

Once an Edit selection is made, you can audition the track range by clicking Play in the Transport window. If enabled, the pre- and post-roll amounts play as well.

### To play a selection:

- 1 Make sure to select Operations > Link Edit and Timeline Selection.
- 2 With the Selector or Grabber, make a track selection.
- 3 If desired, enable and set the pre- and post-roll amounts. For details, see “Setting Pre/Post-Roll” on page 97.
- 4 Click Play in the Transport window.

All tracks plays for the range of the selection, including pre/post-roll if enabled.

### Auditioning Pre- and Post-Roll

You can audition and play *just* the pre-roll or post-roll material for a selection.

#### To play from the pre-roll point to the start of a selection, or to the current cursor location:

- Press Option+Left Arrow (Macintosh) or Alt+Left Arrow (Windows).

#### To play to the post-roll point from the end of a selection, or from the current cursor location:

- Press Command+Right Arrow (Macintosh) or Control+Right Arrow (Windows).

### Auditioning Start and End Points for Selections

There may be times when you want to audition the start or end of a selection without hearing the entire selection. This al-

lows you to quickly check, for instance, whether the beginning or end of a selection includes any unwanted clicks or pops.

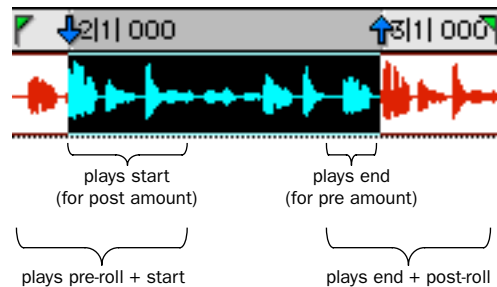

#### Playback ranges for auditioning start/end points

#### To audition a selection start point:

- Press Command+Left Arrow (Macintosh) or Control+Left Arrow (Windows).

When auditioning the beginning of a selection, the selection plays from the start point for a duration equal to the post-roll amount.

#### To audition a selection start point with pre-roll:

- Press Command+Option+Left Arrow (Macintosh) or Control+Alt+Left Arrow (Windows).

#### To audition a selection end point:

- Press Option+Right Arrow (Macintosh) or Alt+Right Arrow (Windows).

When auditioning the end of a selection, playback begins before the end point by the pre-roll amount.

#### To audition a selection end point with post-roll:

- Press Command+Option+Right Arrow (Macintosh) or Control+Alt+Right Arrow (Windows).

## Looping Playback

When Loop Playback is enabled, the selected track range repeats on playback. If there is no selection, playback occurs normally from the current cursor location.

---

▲ A selection must be at least 1 second in length for it to loop on playback.

---

Looping playback is a useful way to check the rhythmic continuity of a selection when working with musical material. If you're working with one-bar selections, you can loop playback to see if the material loops cleanly. If it seems to skip, you should then adjust the length of the selection until it works "musically" within the context of the playlist and the other tracks.

### To loop playback of a selection:

- 1 Make sure to select Operations > Link Edit and Timeline Selection.
- 2 With the Selector, select the track range you want to loop.
- 3 Select Operations > Loop Playback. When enabled, a loop symbol appears in the Play button in the Transport window.



*Loop Playback enabled*

---

\* You can also enable Loop Playback by Control-clicking (Macintosh) or Right-clicking (Windows) the Play button in the Transport window. Or, with the Numeric Keypad Mode set to Transport, press 4 on the numeric keypad.

---

- 4 Click Play in the Transport window.

Playback begins from the pre-roll point (if enabled) and continues to the selection's end point, where it loops back to the start point.

- 5 Click Stop in the Transport window to stop playback.

## Loop Playback and Audio Recording

When Loop Playback is enabled, Pro Tools will not loop when attempting to record audio tracks with QuickPunch, Destructive Record, or Nondestructive Record mode.

To loop record audio tracks in Pro Tools, you must enable Loop Record mode.

---

## Timeline Selections

With the Edit and Timeline selections unlinked, selections can be made in the Timeline that are distinct and separate from Edit selections.

With the Edit and Timeline selections linked, any Edit selections that are made are mirrored in the Timeline.

Whether the Edit and Timeline selections are linked or not, the range indicated by the Playback Markers always determines the range for playback and recording.

---

▲ For TDM systems, when Continuous Scroll with Playhead is enabled, it determines where playback begins. For details, see "Playing Edit and Timeline Selections with the Playhead" on page 173.

---

**To make a Timeline selection with the Selector:**

- 1 If desired, set the Edit mode to Grid to constrain the selection to the current Grid value.
- 2 Drag with the Selector in any Timebase Ruler.

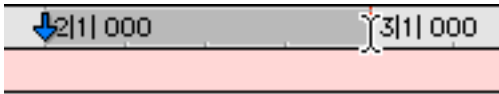

*Making a Timeline selection with the Selector*

The Timeline selection is indicated in the Ruler by the blue Playback Markers (red if a track is record-enabled). The start, end, and length for the Timeline selection is displayed in the corresponding fields in the Transport window.

---

\* To select all tracks, including Conductor tracks, press Option (Macintosh) or Alt (Windows) while dragging in a Timebase Ruler with the Selector.

---

**To set the Timeline selection by dragging the Playback Markers:**

- 1 If desired, set the Edit mode to Grid to constrain movement to the current Grid value.
- 2 With the Grabber, drag the first Playback Marker (down arrow) to set the start point.



*Dragging a Playback Marker*

- 3 Drag the other Playback Marker (up arrow) to set the end point.

**To set the Timeline selection by typing into the Transport window:**

- 1 If necessary, resize the Transport window by clicking in the upper right so the start and end times are displayed.
- 2 In the Transport window, click in the start field.  
– or –

Press Option-slash (Macintosh) or Alt-slash (Windows) to select the start field in the Transport window.

- 3 Type in the new start location and press slash to enter the value and automatically move to the end field.
- 4 Type in the new end location and press Enter to accept the value.

---

\* Use the period (.) or Left/Right Arrow keys to move through the different time fields for start/end. Use the Up/Down Arrow keys to increase or decrease the numerical values.

---

**Sliding a Timeline Selection**

Like Edit selections, Timeline selections can be slid in the Ruler.

**To move a Timeline selection in the Ruler:**

- 1 While pressing Option (Macintosh) or Alt (Windows), move the cursor over either of the Playback Markers (the Grabber appears).
- 2 Drag left or right to move the Timeline selection back or forward in time, while preserving its length.



## **Timeline Selections to/from Edit Selections**

When the Edit and Timeline selections are unlinked, you can copy selections between them.

### **To copy an Edit selection to the Timeline:**

- Choose Operations > Copy Edit Selection to Timeline.

### **To copy a Timeline selection to an Edit selection:**

- Choose Operations > Copy Timeline Selection to Edit.

---

## **Playing Edit and Timeline Selections with the Playhead**

### **(TDM Systems Only)**

When Continuous Scroll with Playhead is enabled, selections in the Timeline do not determine when playback begins. The Playhead, itself, denotes where playback begins when clicking Play in the Transport.

The Edit and Timeline selections, however, can still be played when the Playhead is enabled.

### **To play an Edit selection with the Playhead enabled:**

- 1** Deselect Operations > Linked Edit and Timeline Selections.
- 2** Select Operations > Scroll Options > Continuous Scroll with Playhead.
- 3** With the Selector or Grabber, make a track selection.

- 4** Choose Operations > Play Edit Selection.

The Playhead jumps to the Edit selection and plays it from beginning to end, and then stops.

### **To play a Timeline selection with the Playhead enabled:**

- 1** Deselect Operations > Linked Edit and Timeline Selections.
- 2** Select Operations > Scroll Options > Continuous Scroll with Playhead.
- 3** Drag with the Selector in any Timebase Ruler to set the play range.
- 4** Choose Operations > Play Timeline Selection.

The Playhead jumps to the Timeline selection and plays it from beginning to end, and then stops.

## **Moving the Playhead**

When Continuous Scroll with Playhead is enabled, the Playhead can be moved forward or back to the next region boundary in the selected track.

### **To move the Playhead through a track's region boundaries:**

- 1** Click in the track with the Selector.
- 2** Press Tab to move the Playhead forward to the next region boundary.  
– or –

Press Option+Tab (Macintosh) or Control+Tab (Windows) to move the Playhead back to the previous region boundary.



## chapter 15

# Working with Regions and Selections

Because regions are the basic building block of audio and MIDI tracks, understanding how they are created, edited, and arranged is essential to taking full advantage of the editing capabilities of Pro Tools.

This chapter covers basic editing functions as they apply to regions and selections. The material, for the most part, applies to both MIDI and audio data.

For editing procedures more specific to MIDI, see *Chapter 16: MIDI Editing*. For more advanced editing procedures, see *Chapter 18: Advanced Editing*. You should, however, become familiar with the information in this chapter before moving on to the others.

---

## Creating New Regions

Pro Tools provides you with several commands for creating regions, each of them having a slightly different effect on the selection. When you create a new region, it appears in the Regions List and in the track's playlist. For details on how these new regions are automatically named, see "Auto-Naming Parameters" on page 197.

## Capture Region Command

The Capture Region command defines a selection as a new region and adds it to the Regions List. From there, the new region can be dragged to any existing tracks.

### To capture a new region:

- 1 With the Selector, drag within an existing region to select the material for the new region.

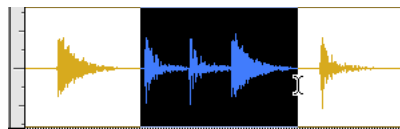

Selecting a region portion

- 2 Choose Edit > Capture Region.
- 3 Enter a name for the new region and click OK.

The new region appears in the Regions List. The selected region portion remains intact and unchanged.

## Separate Region Command

The Separate Region command defines a selection within an existing region as a new region and separates it from adjacent material. If there is no selection, the region is split at the insertion point.

## Auto-Name Separated Regions

With the Auto-Name Separated Regions option in the Editing Preferences selected, Pro Tools automatically names separated regions for you. The name is a numbered variation of the original region's name.

### To separate a new region:

**1** With the Selector, drag within an existing region to select the material for the new region.

– or –

Click with the Selector at the point where you want to split the region in two.

**2** Choose Edit > Separate Region.

**3** If the Editing Preference for Auto-Name Separated Regions is disabled, enter a name for the new region when prompted, then click OK.

The new region appears in the track in which it was created, separate from the data surrounding it. It also appears in the Regions List. From there it can be dragged to other tracks.

By separating a region, additional regions are auto-created from data on either side of the separation, which have new numbers assigned to their names.

---

☞ If the Editing Preference for “Separate Region Operates On All Related Takes” is selected and you are editing a region that is one of a number of related takes with the same User Time Stamp (created with loop recording, for example), the Separate Region command affects each take. For details see, “Editing Preferences and Take Regions” on page 95.

---

## Separation Grabber

### (TDM Systems Only)

You can use the Separation Grabber to automatically separate an edit selection and move it to another location or another track.

### To separate a selection from a region with the Separation Grabber:

**1** With the Selector, drag within an existing region to select the material for the new region.

**2** From the Grabber pop-up, choose the Separation Grabber.



### Separation Grabber

**3** Drag the selection to the new location, or to another track.

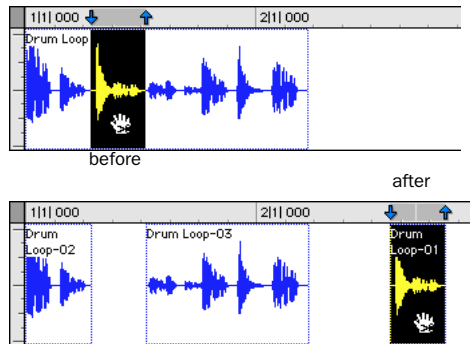

### Dragging later in track with Separation Grabber

A new region containing the previous selection is created, separate from the original region. New regions are also created from the material outside the original selection.

### To turn a selection into a region without affecting the original region:

- 1 With the Selector, drag within an existing region to select the material for the new region.
- 2 From the Grabber pop-up, choose the Separation Grabber.
- 3 While pressing Option (Macintosh) or Alt (Windows), drag the selection to the new location, or to another track.

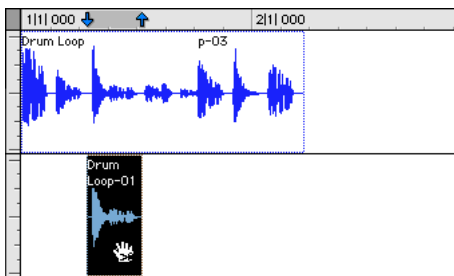

*Dragging to another track with Separation Grabber*

A new region containing the previous selection is created and placed at the new location. The original selection and region remain intact.

### Trim To Selection Command

The Trim To Selection command removes data before and after a region or MIDI note selection, leaving only the selection. This command provides a handy means of quickly removing all data in a region (and in some instances the entire track) except for the current selection.

#### To trim unwanted data from a region or note:

- 1 With the Selector, select a portion of a region or note (or a range of notes).
- 2 Choose Edit > Trim > To Selection to remove material outside of the selection.

---

## Healing a Separation

The Heal Separation command returns separated regions to their original state—provided the regions are still next to each other and their relative start/end points haven't changed since the separation.

If you have trimmed or otherwise changed the start or end points of the two regions, or moved them further away from each other, you won't be able to repair them with the Heal Separation command. It is not possible to heal two regions created from different audio files.

#### To heal a separation between two regions:

- 1 With the Selector, make a selection that includes part of the first region, the entire separation between the regions, and part of the second region.
- 2 Choose Edit > Heal Separation.

If the regions won't heal, there are other ways to return the separated regions to a single region.

- ♦ Delete one of the two separated regions (make sure you're in Slip mode so the gap doesn't close) and use the Trimmer to expand the remaining region to its original length. For information on using the Trimmer, see "The Trimmer Tool" on page 180.
  - or –
- ♦ Delete both of the separated regions and drag the original region from the Regions List to the original location. For information on placing regions, see "Placing Regions in Tracks" on page 178.

---

## Placing Regions in Tracks

Once you have created a region, it appears in the Audio or MIDI Regions List. From there you can drag it to a track to add to an existing arrangement of regions, or you can create a new track and start adding regions from scratch. The exact placement of regions in a track depends on whether the Edit mode is set to Shuffle, Slip, Spot, or Grid (see “Edit Modes” on page 145 for details).

For information on locating regions in the Regions List by typing the first few letters of their name, see “Keyboard Selection of Regions” on page 144.

### To place a region in a track:

- 1 In the Audio or MIDI Regions list, select the region you want to drag to a track. To select more than one region, Shift-click each additional region.
- 2 Drag the selected regions from the Regions List to a track at the desired point.

If dragging multiple regions, the regions are placed on adjacent tracks. This technique is useful for dragging regions that are part of a stereo pair onto two tracks, keeping them lined up and in phase.

Regions are placed according to the current Edit mode:

- In Shuffle mode, existing track regions are slid as necessary to make room for the new region.
- In Spot mode, you are prompted by the Spot dialog to enter a location for the dragged region (see “Spotting Regions” on page 184).

- In Grid mode, the dragged region snaps to the nearest Grid boundary.
- In Slip mode, the regions are placed freely anywhere in the destination track.

---

☞ Use the Replace Region function to replace all occurrences of a region (in all tracks) with a different region from the Regions List. See “Replacing Regions” on page 261.

---

## Placing Regions at the Edit Insertion Point

You can easily place and align a region’s start, end, or sync point to the Edit insertion point. This technique is useful in post production applications since it allows you to set a reference point and quickly place sound effects while ensuring that their start point remains consistent.

You can drag a region from the same track, from another track, or from the Audio or MIDI Regions List.

---

▲ For TDM systems, when Continuous Scroll with Playhead is selected, regions snap to the playhead, instead of the Edit insertion point.

---

### To place the start of a region at the Edit insertion point:

- 1 Click with the Selector in the track at the desired time location.
- 2 While pressing Control (Macintosh) or the Start key (Windows), drag the region from the Regions list, or from another track, to the destination track.  
– or –

If the region is already in the track, Control-click (Macintosh) or Start-click (Windows) the region with the Grabber.

**To place the end of a region at the Edit insertion point:**

1 Click with the Selector in the track at the desired time location.

2 While pressing Command+Control (Macintosh) or Control+Start key (Windows), drag the region from the Regions list, or from another track, to the destination track.

– or –

If the region is already in the track, Command-Control-click (Macintosh) or Control-Start-click (Windows) the region with the Grabber.

**To place the sync point of a region at the Edit insertion point:**

1 Click with the Selector in the track at the desired time location.

2 While pressing Shift+Control (Macintosh) or Shift+Start key (Windows), drag the region from the Regions list, or from another track, to the destination track.

– or –

If the region is already in the track, Shift-Control-click (Macintosh) or Shift-Start-click (Windows) the region with the Grabber.

**Aligning to Region Start Points**

The start, end, and sync point of one region can be aligned to the start of a different region on another track.

---

▲ For TDM systems, if Continuous Scroll with Playhead is enabled, region start, end, and sync points always align to the playhead.

---

**To align the start points of regions on different tracks:**

1 With the Grabber, select the region you want to align to by clicking it.

2 For TDM systems, if Continuous Scroll with Playhead is enabled, move the playhead to the start of the selected region. For details, see “Moving the Playhead” on page 173.

3 With the Grabber, Control-click (Macintosh) or Start-click (Windows) the region to be moved.

– or –

Control-drag (Macintosh) or Start-drag (Windows) a region from the Regions List to another track.

The start point of the second region is aligned to the start of the first region.

**To align the end point of a region to the start of another region (on a different track):**

1 With the Grabber, select the region you want to align to by clicking it.

2 For TDM systems, if Continuous Scroll with Playhead is enabled, move the playhead to the start of the selected region. For details, see “Moving the Playhead” on page 173.

3 With the Grabber, Command-Control-click (Macintosh) or Control-Start-click (Windows) the region to be moved.

– or –

Command-Control-drag (Macintosh) or Control-Start-drag (Windows) a region from the Regions List to another track.

The end point of the second region is aligned to the start of the first region.

**To align the sync point of a region to the start of another region (on a different track):**

- 1 With the Grabber, select the region you want to align to by clicking it.
- 2 For TDM systems, if Continuous Scroll with Playhead is enabled, move the playhead to the start of the selected region. For details, see “Moving the Playhead” on page 173.
- 3 With the Grabber, Shift-Control-click (Macintosh) or Shift-Start-click (Windows) the region to be moved.
  - or –

Shift-Control-drag (Macintosh) or Shift-Start-drag (Windows) a region from the Regions List to another track.

The sync point of the second region is aligned to the start of the first region.

---

## The Trimmer Tool

### Standard Trimmer

With the Trimmer tool, you can quickly shorten or expand a region (up to the entire length of the source audio file). The first time you trim a region, Pro Tools automatically adds it to the Regions List as a new region (with a name derived from the original) in order to differentiate it from the original.

The Trimmer is a nondestructive tool and doesn't actually modify the original audio or MIDI data (when working on regions). To return to the length of the original region, drag it from the Regions List, or resize the edited region with the Trimmer to its original length.

Use of the Trimmer is affected by the current Edit mode: Shuffle, Slip, Spot, or Grid. See “Edit Modes” on page 145 for more information.

---

\* The Standard Trimmer can also be used to lengthen and shorten MIDI notes (see “Trimming Note Start and End Times” on page 204), and also to scale automation and controller data up or down “Editing Automation” on page 301.

---

▲ For TDM systems, the Trimmer has three modes: Standard Trimmer (discussed in this section), Scrub Trimmer (see “The Scrub Trimmer” on page 181), and Time Trimmer (see “The Time Trimmer” on page 258).

---

### To trim a region:

- 1 Select the Trimmer tool.



*Standard Trimmer*

---

▲ For TDM systems, make sure the Standard Trimmer is selected in the Trimmer pop-up menu.

---

- 2 Move the cursor near the start or end of the region, so the Trim cursor appears.



*Trim cursor*

---

\* To reverse the direction of the Trim cursor, press Option (Macintosh) or Alt (Windows).

---



**3** If trimming the end, drag left to shorten the region, right to lengthen.

– or –

If trimming the start, drag right to shorten the region, left to lengthen.

When using Shuffle mode, adjacent regions are slid as necessary to make room for the edited region. If using Grid mode, the dragged start/end times snap to the nearest Grid boundary. If using Spot mode, the Spot dialog opens, where you can enter the new location for the region's start or end point.

## The Scrub Trimmer

(TDM Systems Only)

The Scrub Trimmer is a convenient tool for auditioning material (on up to two tracks) to find a trim point. You can click on a track and drag to hear the audio information, then trim at a specific location by releasing the mouse button.

This action creates a new region. Note that the cursor changes into a “right trim” or “left trim” shape as it is placed over the right or left side of a region. To reverse the direction of the Scrub Trimmer, press Option (Macintosh) or Alt (Windows) before you click on the region.

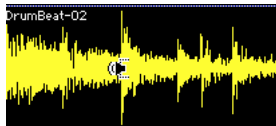

*Scrub Trimmer over a region*

Scrub playback speed and direction vary with controller movement. Scrubbed audio is routed through the track signal path, so you hear any effects in the signal path.

**To scrub trim a track:**

**1** Click the Scrub Trimmer tool. The cursor changes to a speaker with a bracket.

**2** Drag within a track to the left or right. Audio from a scrubbed track is routed through the track signal path, including any TDM effects. When you locate the desired trim point, release the mouse button to trim the region.

To scrub trim two tracks, click with the Scrub Trimmer between two adjacent tracks and drag.

To scrub with finer resolution (without having to zoom in), press Command (Macintosh) or Control (Windows) while scrubbing.

## Trim To Insertion Command

You can trim a region or MIDI note by automatically removing the material between the Edit insertion point and the start or end point.

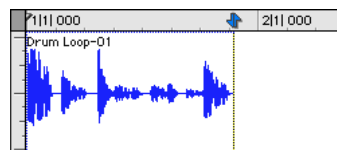
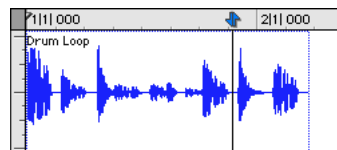

*Region end trimmed to insertion*

### **To trim from a start point to insertion:**

- 1 With the Selector, click inside the region or note where you want the new start point to be.
- 2 Choose Edit > Trim > Start To Insertion. The region's start point is automatically trimmed to the insertion point.

### **To trim from an end point to insertion:**

- 1 With the Selector, click inside the region or note where you want the new end point to be.
- 2 Choose Edit > Trim > End To Insertion. The region's end point is automatically trimmed to the insertion point.

## **Trimming with Nudge**

You can trim the start and end points of a region by nudging them.

### **To trim a region's start or end point by the Nudge value:**

- 1 Configure the Nudge value as desired. For details, see "Defining the Nudge Value" on page 187.
- 2 With the Grabber, select the region you want to trim.
- 3 While pressing Option (Macintosh) or Alt (Windows), press Plus or Minus on the numeric keypad to trim the region's start point by the Nudge value.

– or –

While pressing Command (Macintosh) or Control (Windows), press Plus or Minus on the numeric keypad to trim the region's end point by the Nudge value.

---

## **Moving Regions**

A region or group of selected regions (on the same track or on multiple tracks) can be moved with the Grabber tool. This feature is useful in music and post production applications where the timing of audio events such as sound effects and dialog need to be spotted to music, film, or video.

Moving and placing regions is affected by whether the current Edit mode is set to Shuffle, Slip, Spot, or Grid. See "Edit Modes" on page 145 for details.

---

\* You can drag a copy of a region to another location or track by pressing Option (Macintosh) or Alt (Windows) while dragging.

---

## **Region Sync Points**

The placement of regions in Grid and Spot mode can be based on the definition of a region sync point. Sync points are used when a point within a region must be aligned to the Grid or to a particular SMPTE or bar/beat location. This capability is important in placing music and sound effects for film and video work.

For example, suppose you had an audio region for a door slam that included the creak of the door closing, the actual slam, and the reverb of the slam. You may want to align the "slam" to other locations within the session.

### To identify a region sync point:

- 1 Set the Edit mode to Slip by clicking its button in the upper left of the Edit window.
- 2 With the Selector, click in the region at the point, usually the peak of the waveform, where you want to define the sync point.
- 3 Choose Edit > Identify Sync Point. A small down arrow appears at the bottom of the region, indicating the location of the sync point.

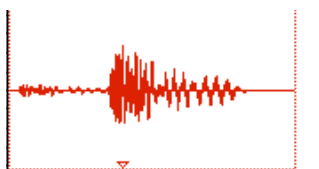

*Sync point defined*

To remove a sync point, select the region and choose Edit > Remove Sync Point.

## Shuffling Regions

In Shuffle mode, you can move regions freely within a track or onto another track, but their movement is constrained by other regions. That is, if you place several regions in a track, their start and end points automatically snap to each other. You can then “shuffle” their order, but you cannot separate them from each other and you cannot make them overlap as in Slip mode. In Shuffle mode, adding another region to the beginning of a track moves all subsequent regions to the right by the length of the region added.

### To shuffle regions:

- 1 Set the Edit mode to Shuffle by clicking its button in the upper left of the Edit window.
- 2 Drag a region from the Regions List to an empty track. The region snaps to the beginning of the track.
- 3 Drag a second region from the Regions List to the same track, somewhere in the middle. The start point for the second region snaps to the end of the first region.
- 4 With the Grabber, drag the second region to the beginning of the track.

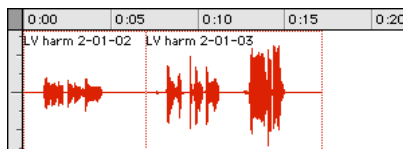

*Regions placed in Shuffle mode*

Pro Tools “shuffles” the position of the two regions. The second region now occurs first, yet the two still cling together.

Experiment more with Shuffle mode by dragging additional regions to the track and rearranging them.

Locked regions (see “Locking Regions” on page 189), and all regions occurring after the locked region, are not displaced when other neighboring regions are moved in Shuffle mode. If there is not enough room to place or duplicate a region in front of a locked region, the insertion area is disabled.

If you place a region in Slip mode and switch to Shuffle mode, Pro Tools preserves the relative timing and position of the slipped region, and any blank space between it and other regions.

## Moving Regions in Slip Mode

In Slip mode, regions can be moved with the Grabber freely within a track, or onto other tracks. In this mode it is possible to place a region so that there is space between it and other regions in a track. When the track is played back, this space is silent. It is also possible to move a region so that it overlaps or completely covers another region.

### To slip regions:

- 1 Set the Edit mode to Slip by clicking its button in the upper left of the Edit window.
- 2 Drag a region from the Regions List to an empty track.
- 3 Drag a second region from the Regions List to the same track, somewhere in the middle. The second region is placed wherever you release it. It doesn't snap to the first region as in Shuffle mode.

Drag the regions to different locations within the track to get a feel for moving them in Slip mode. Try placing the second region so that it slightly overlaps the first region. Play back the results.

## Spotting Regions

Spot mode is useful for sessions in which you want to spot regions to precise locations based on any of the Time Scales. This can be particularly useful when performing post production tasks with SMPTE frame locations. In Spot mode you can spot a region by specifying a SMPTE frame or bar/beat location, by capturing an incoming time code address, or by using the region's time stamps.

---

☞ For even quicker spotting, if you are using VITC, use the Auto-Spot Regions command to spot a region to the current SMPTE frame location with the Grabber. For more information, see “Auto-Spotting Regions” on page 360.

---

### To spot a region:

- 1 Set the Edit mode to Spot by clicking its button in the upper left of the Edit window.
- 2 Drag a region from the Regions List to an existing track.

– or –

Click on a region already in a track with the Grabber.

- 3 In the Spot dialog, select the desired time format from the Time Scale pop-up menu.

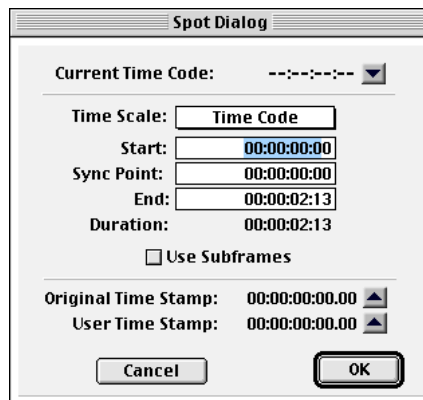

### Spot dialog

Each of the fields in the Spot dialog are displayed in the chosen Time Scale.

- 4 If the Time Scale is set to Time Code, select the Use Subframes option to display subframes in the fields for great accuracy.

5 Click in the field for Start, Sync Point, or End and type in a new location.

– or –

Click one of the up arrows next to Original Time Stamp or User Time Stamp to enter the associated values into the currently selected field.

– or –

If you are using an external SMPTE time code source, click the down arrow next to the Current Time Code display (or press Equal (=) on the numeric keypad) to capture an incoming time code address.

6 Click OK. The region is moved to the new location specified for its start or sync point.

---

\* If a region does not have a sync point defined, the Sync Point field in the Spot dialog functions the same as the Start field.

---

To learn more about using SMPTE with Pro Tools, refer to *Chapter 24: Time Code Synchronization*.

## Region Time Stamps

When a region is created, it is time stamped relative to the SMPTE start time specified for the session. This Original Time Stamp is permanently stored with the region and cannot be changed. If a region is ever moved, it can easily be placed at its original position from the Spot dialog.

When the Original Time Stamp for a region is initially set, this same location is also used to define the region's User Time Stamp.

Unlike the Original Time Stamp, the User Time Stamp can be redefined with the Time Stamp Selected command in the Regions List pop-up menu. For more information, see "Time Stamping" on page 361.

Regions with identical User Time Stamps appear together in the Takes List pop-up when auditioning takes. For more information, see "Auditioning from the Takes List Pop-up Menu" on page 94.

## Moving Regions in Grid Mode

In Grid mode, the movement and placement of regions is constrained to the current Grid value. Grid boundaries, depending on the Main Time Scale, can be based on frames, bar and beat values, minutes or seconds, or a number of samples.

This mode is especially useful for lining up regions at precise intervals, as when working with a session that is bar/beat based. For example, if the Grid value is set to quarter-notes (0|1|000), dragging a region to a new location causes it to snap to the nearest quarter-note boundary.

When the Display Preference for "Draw Grid in Edit Window" is enabled, vertical Grid lines appear in the Edit window.

---

\* Grid lines in the Edit window can also be enabled and disabled by Control-clicking (Macintosh) or Right-clicking (Windows) the Indicator Dot for any Timebase Ruler.

---

## Defining the Grid Value

In addition to affecting the placement of regions, the Grid value also constrains Edit and Timeline selections, and determines how the Quantize Regions command works.

### To set the Grid value:

**1** From the Display menu, select the Time Scale you will use for the Grid value.

– or –

To keep the Main Time Scale and use a different time format for the Grid, deselect Follow Main Timebase in the Grid Value pop-up in the upper right of the Edit window.

**2** From the Grid Value pop-up in the upper right of the Edit window, select the time value that will define the Grid boundaries.

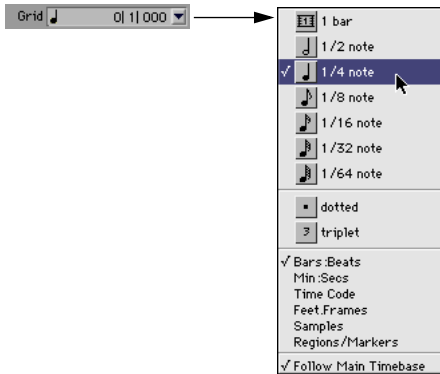

*Grid Value pop-up showing Bars:Beats*

– or –

To define a Grid based on the session's Markers, selections, and region boundaries, select Regions/Markers from the Grid Value pop-up.

### To place or move a region while in Grid mode:

**1** Configure the Grid value as desired. For details, see “Defining the Grid Value” on page 186.

**2** Drag a region from the Regions List to an existing track.

– or –

With the Grabber, drag a region already in a track to a new location.

The region's start point snaps to the closest Grid boundary. If the region has a sync point defined, the sync point snaps to the Grid boundary.

---

## Nudging

Pro Tools allows you to nudge regions and selections (or MIDI notes) by precise increments with the Plus and Minus keys on the numeric keypad. The amount of the nudge is determined by the value specified in the Nudge pop-up menu. The Nudge function can be used in any of the Edit modes.

Nudging can be invaluable for adjusting the “groove” of a musical phrase or a sound effect relative to other elements in the session. Since Pro Tools lets you nudge material during playback, you can nudge continuously in real time to adjust the timing relationship between tracks.

---

 Nudge can also be used to adjust the placement of automation breakpoints. For more information, see “Editing Automation” on page 301.

---

## Defining the Nudge Value

The Nudge value determines how far regions and selections are moved when nudging.

Start and end points for selections can also be moved by the Nudge value (see “Nudging Selection Start/End Points” on page 165). In addition, regions can be trimmed by the Nudge value (see “Trimming with Nudge” on page 182).

### To set the Nudge value:

**1** From the Display menu, select the Time Scale you will use for the Nudge value.

– or –

To keep the Main Time Scale and use a different time format for the Nudge value, deselect Follow Main Timebase in the Nudge pop-up in the upper right of the Edit window.

**2** From the Nudge pop-up menu in the upper right of the Edit window, select the Nudge value.

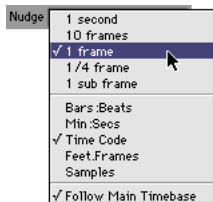

*Nudge pop-up showing Time Code*

To specify a Nudge value not listed in the Nudge pop-up, click in the Nudge field and type in the value.

### To nudge a selection or region:

**1** Configure the Nudge value as desired. For details, see “Defining the Nudge Value” on page 187.

**2** Using either the Selector or Grabber, select the track material to be nudged. The selected material can even reside on multiple tracks.

**3** On the numeric keypad, press Plus (+) to move the selection forward by the Nudge value.

– or –

Press Minus (-) to move the selection back by the Nudge Value.

The Nudge command works the same regardless of the Edit mode. Adjacent regions are overlapped in Shuffle mode, the Spot dialog does not appear when in Spot mode, and shifted material does not snap to the Grid when in Grid mode.

## Nudging by Next Nudge Value (TDM Systems Only)

In addition to nudging by the current Nudge Value, you can also nudge by the next value in the Nudge pop-up.

For example, if the Nudge Value is set to 1 frame and you want to nudge by a larger value, you can nudge by the next Nudge Value of 10 frames.

### To nudge forward or back by the next Nudge Value:

**1** Enable the Key Commands Focus by clicking the a-z button in the upper left of the Edit window.

**2** With the Selector or Grabber, select the regions or notes you want to nudge.

**3** Press slash (/) to nudge the selected material forward by the next Nudge Value. Press M to nudge the selection back.

\* You can also nudge by the next Nudge Value without enabling the Commands Key Focus. While pressing Control (Macintosh) or the Start key (Windows), press slash or M.

## Nudging a Region's Contents

Often a region's start point will reside at the correct location, perhaps at a SMPTE frame or bar, but the material within the region starts too late or early. You can, in effect, nudge a region's audio waveform or MIDI notes without displacing the region's start and end points.

This "sliding" of region contents is only possible if there is material residing outside the region's start and end points—from the region having been trimmed, or perhaps captured from a larger region.

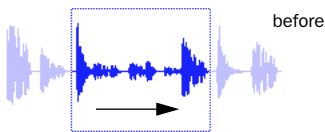

region contents are slid, moving waveform material into and out of the current region boundaries

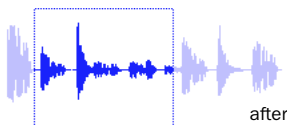

*Nudging region content*

**To nudge the contents of a region without changing the region start/end points:**

**1** Configure the Nudge value as desired. For details, see "Defining the Nudge Value" on page 187.

**2** With the Grabber, select the region whose contents you want to nudge.

**3** While pressing Control (Macintosh) or the Start key (Windows), press Plus or Minus on the numeric keypad to move the material by the Nudge value.

## Shift Command

Use the Shift command to move track material forward or back in time by a specified amount. The Shift command can operate on regions, MIDI notes, MIDI controller data, and automation breakpoints.

**To shift a selection or region:**

**1** Using either the Selector or Grabber, select the track material to be shifted. The selected material can even reside on multiple tracks.

**2** Choose Edit > Shift. In the Shift dialog, select whether the data will be moved Earlier or Later.

**3** Click in one of the Timebase fields to specify the amount the material will be shifted. Entering a value in one Timebase field automatically updates the others.

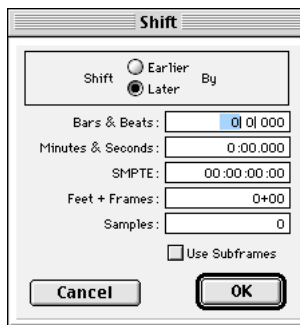

*Shift dialog*



- 4 If desired, select the Use Subframes option for greater accuracy.
- 5 Click OK. The material is shifted back or forward by the specified amount.

If a portion of a region was selected, new regions are created from the selection and from any material outside of the selection.

The Shift command works the same regardless of the Edit mode. Adjacent regions are overlapped in Shuffle mode, the Spot dialog does not appear when in Spot mode, and shifted material does not snap to the Grid when in Grid mode.

---

## Quantizing Regions

The Quantize Regions command allows you to adjust the placement of selected audio and MIDI regions so that their start points (or sync points, if they contain one) precisely align to the nearest Grid boundary, which can be based on frames, bar and beat values, minutes or seconds, or a number of samples.

### To quantize one or more regions:

- 1 Configure the Grid value as desired. For details, see “Defining the Grid Value” on page 186.
- 2 With the Grabber or Selector, select the region or regions to be quantized.
- 3 Choose Edit > Quantize Regions. Region start times (or sync points) are aligned to the boundaries for the defined Grid.

For MIDI regions, all data contained within the regions (such as notes) are moved equally, thereby retaining their rhythmic

relationships. To quantize individual MIDI notes, use the Quantize command in the MIDI menu (see “Quantize” on page 214).

---

## Locking Regions

If you have a region or group of regions that you want to permanently associate with a particular location in a track (a beat, SMPTE frame, or sample location), you can lock it in place so it will not be accidentally moved.

### To lock a region:

- 1 With the Grabber, select the region or regions to be locked.
- 2 Choose Edit > Lock Region/Unlock Region.



*Locked audio region*

A small lock appears in the region, indicating it has been locked and cannot be moved. If you attempt to perform edits that would move a locked region, Pro Tools alerts you.

In Shuffle mode, locked regions, and all regions occurring after the locked region, are not displaced when other neighboring regions are moved. If there is not enough room to place or duplicate a region in front of a locked region, the insertion area is disabled.

---

▲ Locking a region prevents it from being moved only—operations such as recording and automation editing still affect it.

---

---

## Muting/Unmuting Regions

Choosing the Mute/Unmute Region command mutes playback of a selected region. Choosing the command a second time unmutes the region. Regions that are muted become dimmed to indicate their status.

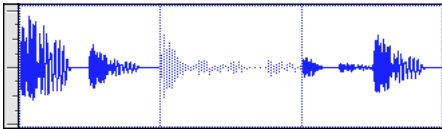

*Muted audio region (middle)*

### To mute a region or regions:

- 1 With the Grabber, select the region or regions you want to mute.
- 2 Choose Edit > Mute/Unmute Region. The selected regions become dimmed, indicating they are muted.

To unmute a region, select it and choose Edit > Mute/Unmute Region.

---

## Edit Commands

### Cut, Copy, Clear, and Paste

Use the Cut, Copy and Paste commands to rearrange and edit track material. Edits can operate on entire regions selected with the Grabber, or on track ranges selected with the Selector. Edits can also work across multiple tracks (see “Editing across Multiple Tracks” on page 193).

---

\* For TDM systems, you can cut, copy, and paste discontinuous regions selected with the Object Grabber.

---

When cutting or copying track material, the track’s Display Format determines the type of data placed on the Clipboard. When displaying waveforms for audio tracks, or notes or regions for MIDI tracks, selections include all underlying automation and controller data. Thus, cutting an audio region also cuts any Volume, Pan, Mute, Send, or Plug-In automation that is also on the track. This saves you from having to individually cut from each automation playlist on the track.

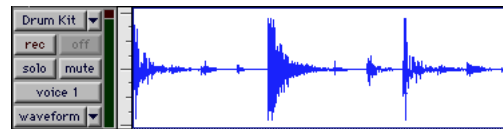

*Audio waveform data*

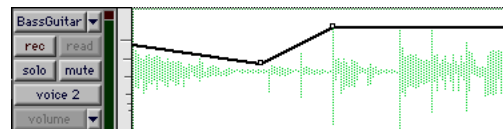

*Automation data (breakpoint-type data)*

However, when selecting groups of MIDI notes with the Grabber (by drawing a rectangle around them), only the note data is placed on the Clipboard. When selecting a time range of MIDI notes with the Selector, all controller data in the track is selected (similar to selecting with the Selector for audio tracks in Waveform view).

When a track is displaying automation data or controller data, only that data is placed on the Clipboard. Also, whenever you cut or copy automation data, bounding breakpoints are created at each end of the selected area, in order to preserve the slope of the automation both inside and outside the selection.

If tracks are grouped, copying and pasting on any of the tracks affects each of the other tracks in the group. Tracks that are hidden—even if they are part of a group being edited—are not affected by edits.

The current Edit mode affects how material is selected, copied, and pasted:

- In Slip mode, the Cut command leaves an empty space corresponding to the data removed from the track.
- In Shuffle mode, the Cut command leaves no empty space, since the regions to the right of the cut slide over, closing the gap.
- In Slip mode, pasted data can overlap an adjacent region.
- In Shuffle mode, pasted data causes all regions to slide over to make room for the pasted material.

New regions are often auto-created when performing edits. For instance, when clearing a selection from a region, new regions are auto-created from the material residing outside of the selection.

## Clear Command

Use the Clear command to remove a selection from a track without placing it on the Clipboard.

### To clear a selection or region:

- 1 If desired, set the Edit mode to Grid to constrain the selection to the current Grid value.
- 2 Set the Display Format for the tracks you want to edit.

When displaying waveforms for audio tracks, or notes or regions for MIDI tracks, selections include underlying automation

and controller data. If the track is displaying automation data, only the automation data is affected by the edits.

- 3 Drag with the Selector in the track to select the material you want to clear.

– or –

Use the Grabber to select one or more regions (or a group of MIDI notes).

- 4 Choose Edit > Clear to remove the selection.

If a portion of a region was cleared, new regions are auto-created from the material residing outside of the selection. If working in Shuffle mode, adjacent regions are slid over, as necessary, to fill the blank space.

## Cut and Copy Commands

Use the Copy command to place a selection on the Clipboard so it can be pasted to another track, or to the same track at a different location.

Use the Cut command to place the selection on the Clipboard while also removing it from the track.

### To cut or copy a selection or region:

- 1 If desired, set the Edit mode to Grid to constrain the selection to the current Grid value.
- 2 Set the Display Format for the tracks you want to edit.

When displaying waveforms for audio tracks, or notes or regions for MIDI tracks, selections include underlying automation and controller data. If the track is displaying automation data, only the automation data is affected by the edits.

**3** Drag with the Selector in the track to select the material you want to cut or copy.  
– or –

Use the Grabber to select one or more regions (or a group of MIDI notes).

**4** Choose Edit > Cut to remove the selection and place it on the Clipboard.  
– or –

Choose Edit > Copy to place the selection on the Clipboard, without removing it.

If a portion of a region was cut or copied, the material on the Clipboard appears as a new region in the Regions List. If a portion of a region was cut, new regions are auto-created from the material residing outside of the selection.

When working in Shuffle mode, adjacent regions are slid over, as necessary, to fill blank spaces.

### **Deleting Underlying Region Data**

In Slip mode, Regions can be placed so that they overlap or completely cover other regions. When removing a region or selection, you can also remove the underlying region data.

#### **To delete a region or selection along with the underlying region data:**

- Choose Edit > Cut.

#### **To delete a region or selection without removing the underlying region data:**

- Choose Edit > Clear.

### **Paste Command**

Use the Paste command to place the Clipboard's contents at the Edit insertion point, overwriting existing material already there.

#### **To paste a selection or region:**

**1** If desired, set the Edit mode to Grid to constrain the insertion point or selection to the current Grid value.

**2** With the Selector, click in a track at the point where you want to paste the material. Press Tab to move the insertion point forward to region start and end times—to move back, press Option+Tab (Macintosh) or Control+Tab (Windows).

– or –

Use the Selector or Grabber to make a selection where the material will be placed.

**3** Choose Copy > Paste.

If pasting at an insertion point in Shuffle mode, material to the right of the paste point is shifted to the right. In Slip mode, the material is overwritten with the paste.

If pasting into a selection in Shuffle mode, the selection is replaced by the Clipboard's contents with the adjacent material slid left or right as necessary. In Slip mode, the selection is also replaced but with the surrounding material remaining unchanged.

---

☞ For TDM systems, the Fill Paste command can be used to fill a selection with the contents of the Clipboard. For details, see “Repeat Paste To Fill Selection” on page 260.

---

---

☞ When working with MIDI, you can merge the contents of the Clipboard with material in the destination track. For details, see “Merge Paste Command” on page 195.

---

## Copying and Pasting Automation

Following are two special functions for copying and pasting automation data.

- ◆ To copy all automation playlists for a track, press Control (Macintosh) or the Start key (Windows) when copying from any of the track's automation playlists. This special function also works across multiple tracks.

- ◆ To paste from one type of automation playlist to another similar playlist (for instance, from a volume playlist to a send level playlist), press Control (Macintosh) or the Start key (Windows) when pasting.

For more information on working with automation data, see *Chapter 21: Automation*.

## Editing across Multiple Tracks

When working with data from multiple tracks, there are some important points to remember.

For instance, if any of the selected tracks are set to display audio or MIDI regions (or MIDI notes), edits affect not only MIDI and audio for the selected tracks, but *all* automation and controller data as well.

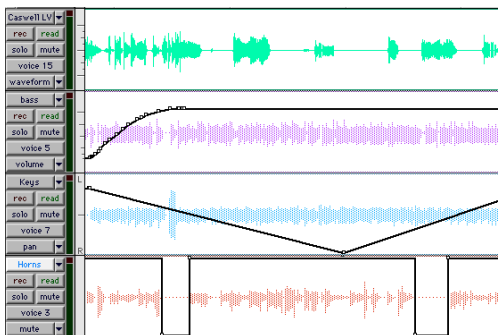

Tracks displayed in different data formats

If all selected tracks are displayed as automation data, edits only affect the type of automation data displayed in each track. Thus, if track 1 displays Pan automation, track 2 displays Volume automation, and track 3 displays Mute automation, the Cut command cuts *only* pan data from track 1, volume data from track 2, and mute data from track 3.

---

\* For details on selecting data on multiple tracks, see “Making a Selection Across Multiple Tracks” on page 167.

---

When copying only automation or controller data for selected tracks, press Control (Macintosh) or the Start key (Windows) to copy all types of automation on *all* selected tracks.

To paste to multiple tracks, place the insertion point in each of the destination tracks by Shift-clicking in them—or to select all tracks, Option-Shift-click (Macintosh) or Alt-Shift-click (Windows) in a track, or make a selection in one of the Timebase Rulers.

When you paste multiple types of data, whatever data has been copied is pasted into the correct type of playlist. Automation data is pasted into the appropriate automation playlist (pan, volume, mute and so on). Audio/MIDI data is pasted into the audio/MIDI playlist. You don't need to set target tracks to the specific type of data being pasted for the paste to work correctly.

If *all* destination tracks in a multitrack paste are displayed as automation, the paste replaces any previous data on the target track without shuffling—regardless of whether you are in Slip or Shuffle mode.

---

## Duplicate Command

The Duplicate command copies a selection and places it immediately after the end of the selection. Though this is similar to using Copy and Paste, Duplicate is more convenient and faster, particularly when working with data on multiple tracks.

To make more than one copy of a selection, use the Repeat command (see “Repeat Command” on page 194).

As with the Copy and Paste commands, certain rules apply when duplicating material on multiple tracks. For details, see “Editing across Multiple Tracks” on page 193.

### To duplicate a selection or region:

- 1 If working with material that is bar- and beat-based, such as loops, set the Main Time Scale to Bars:Beats.
- 2 If desired, set the Edit mode to Grid to constrain the selection to the current Grid value.
- 3 Drag with the Selector in the track to select the material you want to duplicate.  
– or –

Click in the track and enter the start and end points for the selection in the Event Edit area.

- 4 Choose Edit > Duplicate. The material is placed immediately after the selection’s end point.

In Shuffle mode, the duplicated data is placed directly after the end of the selection. Regions occurring after it are slid to accommodate the duplicated material. In Slip mode, the duplicated material overlaps any adjacent data.

---

\* When using Duplicate or Repeat with MIDI notes that were selected with the Grabber, material is always duplicated one measure later, and is merged with existing track material (instead of replacing).

---

## Duplicating Audio

When using Duplicate or Repeat for audio that must fall cleanly on the beat (for loops), it is important that you select the audio material with the Selector, or by typing in the start and end points in the Event Edit area. If you select an audio region with the Grabber (or by double-clicking it with the Selector), the material may drift by several ticks because of sample-rounding.

If, on the other hand, you want to Duplicate or Repeat audio that is not bar- and beat-based, set the Time Scale to any format except Bars:Beats. This ensures that the duplicated audio material will have the correct number of samples and will be placed accordingly.

---

## Repeat Command

The Repeat command is similar to Duplicate, but allows you to specify the number of times the selected material is duplicated.

As with the Copy and Paste commands, certain rules apply when repeating material on multiple tracks. For details, see “Editing across Multiple Tracks” on page 193.

### To repeat a selection or region:

- 1 If working with material that is bar- and beat-based, such as loops, set the Main Time Scale to Bars:Beats.
- 2 If desired, set the Edit mode to Grid to constrain the selection to the current Grid value.
- 3 Drag with the Selector in the track to select the material you want to repeat.  
– or –

Click in the track and enter the start and end points for the selection in the Event Edit area.

- 4 Choose Edit > Repeat. In the Repeat dialog, enter the number of times you want the material to repeat, then click OK.

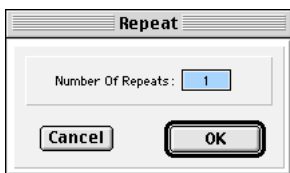

#### *Repeat dialog*

The material is placed immediately after the selection's end point, and duplicated by the number of times specified.

In Shuffle mode, the repeated data is placed directly after the end of the selection. Regions occurring after it are slid to accommodate the repeated material. In Slip mode, the repeated material overlaps any adjacent data.

---

## Merge Paste Command

### (MIDI Only)

Use the Merge Paste command to merge MIDI notes from the Clipboard with material already residing in the paste destination. To replace track material, use the Paste command instead.

### To merge MIDI data:

- 1 If desired, set the Edit mode to Grid to constrain the selection to the current Grid value.
- 2 Drag with the Selector in the track to select the MIDI notes you want to merge.  
– or –

Use the Grabber to select one or more MIDI regions (or a group of MIDI notes).

- 3 Choose Edit > Cut to remove the selection and place it on the Clipboard.  
– or –

Choose Edit > Copy to place the selection on the Clipboard without removing it.

- 4 With the Selector, click in a MIDI track at the point where you want to merge the material.

- 5 Choose Edit > Merge Paste. The Clipboard's contents are pasted at the insertion point, without removing the existing material already residing there.

If any portion of the material is pasted outside of existing regions, a new region is created for the data.

---

## Consolidate Selection Command

During the course of normal edit operations, a track may eventually contain many regions. However, once a track or track range (such as a verse or chorus) reaches a satisfactory state, you may want to consolidate its regions into a single region—thus making the material much more easy to work with.

When consolidating an audio track, a new audio file is written that encompasses the selection range, including any blank space.

### To consolidate regions within a track:

**1** Using the Grabber or Selector, select the regions to be consolidated.

– or –

To select all regions in a track, triple-click in its playlist with the Selector.

**2** Choose Edit > Consolidate.

A new, single region is created that replaces the previously selected regions, including any blank space. If working with an audio track, a new audio file is written (with the Audio Suite Duplicate Plug-In).

When consolidating audio regions with the Consolidate Selection command, if the selection contains muted regions, the muted regions are treated as silence. Whether or not a track is muted, or contains Mute automation, does not affect the Consolidate Selection command.

You can delete any unused regions from the Regions List window. See “Removing Unwanted Regions” on page 198 for details.

---

## Managing Regions

A typical session can become quite busy with many tracks and dozens of regions. There are a number of things you can do, however, to keep track of and manage a session’s regions, which include:

- Renaming existing regions
- Specifying how auto-created regions are named
- Hiding auto-created regions
- Removing unused regions

## Renaming Regions

In the course of a session you can rename regions to give them more descriptive names, or merely to shorten or simplify an existing name. When renaming a region that was auto-created from an edit, the region becomes a user-defined region and is displayed in the Regions List when auto-created regions are hidden.

Perhaps the easiest way to rename a region, if it resides in a track, is to double-click it with the Grabber. However, if the region does not yet reside in a track, or if you want to rename several regions, use the Rename Selected command.

### To rename one or more regions:

**1** If you will be renaming an auto-created region, make sure to select Display > Auto-Created Regions.

**2** Select the region to be renamed in either the Audio or MIDI Regions List. To rename more than one region, Shift-click additional regions.



\* If the Editing Preference for “Regions List Selection Follows Track Selection” is enabled, you can highlight a region in the Regions List by selecting it in a track.

3 Choose Rename Selected from the Regions List pop-up menu.

4 When prompted, enter a new name for the region. If a whole-file audio region was selected, specify whether just the region is renamed, or the region *and* the disk file.

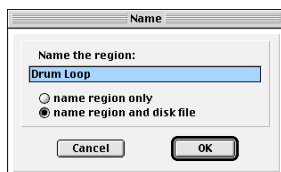

*Rename Selected dialog*

5 Click OK to rename the region. If renaming multiple regions, you are prompted, successively, to rename each region.

## Auto-Naming Parameters

You can specify the auto-naming parameters for a region when new regions are created from it in the course of editing.

### To set auto-naming parameters for a region:

- 1 Select a region in the Audio or MIDI Regions List.
- 2 Choose Auto Rename Selected from the Regions List pop-up menu.
- 3 In the Auto-Rename dialog, enter the text to be used when naming regions created from the selected region.



*Auto-Rename Selected dialog*

**Name** Determines the root name for the auto-created regions.

**Auto Number Start** Sets the start number for the sequentially numbered new regions.

**Leading Zeros** Determines the number of zeros that occur before the auto numbers.

**Suffix** Specifies text to be appended to the end of the name, following the auto numbering.

4 When you are finished, click OK to accept the new naming parameters.

## Hiding and Removing Unwanted Regions

In the course of editing a session, the Audio and MIDI Regions Lists can fill up quickly with regions—ones you’ve created purposely and those that are automatically created by cutting, pasting, and separating other regions. Pro Tools allows you to hide or remove regions in your session so you don’t have to scroll through unnecessarily long Regions Lists.

## Hiding Auto-Created Regions

You can hide regions that were automatically created during the course of editing.

### To hide auto-created regions:

■ Deselect **Display > Display Auto-Created Regions**. With this option deselected, only user-created regions appear in the Audio and MIDI Regions List.

User-defined regions include:

- Whole-file regions
- Regions created during recording
- Imported regions
- Renamed regions
- Regions created as a result of AudioSuite processing
- New regions created with **Capture Region** and **Separate Region** commands
- Regions created by trimming whole-file audio regions

When auto-created regions are hidden, Pro Tools warns you if the number of auto-created regions exceeds a certain threshold, and gives you the option of deleting them. If you choose to delete them, all auto-created regions are deleted at the same time. This prevents a large build-up of auto-created regions, which can affect system performance.

To ensure that you keep a particular auto-created region, turn it into a user-created region by renaming it. For details, see “Renaming Regions” on page 196.

## Removing Unwanted Regions

You can locate and remove any unused regions in a session with the **Clear Selected** command.

---

▲ The **Clear Selected** command cannot be undone and should be used with care.

---

### To find and remove unused regions in a session:

**1** For MIDI regions, choose **Select Unused** from the MIDI Regions List pop-up menu.

– or –

For all audio regions, including whole-file regions, choose **Select Unused > Regions** from the Audio Regions List pop-up menu.

– or –

For all audio regions except whole-file regions, choose the **Select Unused > Regions Except Whole Files**.

**2** After all unused regions are selected, choose **Clear Selected** from the Regions List pop-up menu.

**3** Click **Remove** to remove the unused regions from the session.

– or –

If clearing a whole-file audio region and you want to permanently remove the audio file from your hard drive, click **Delete**.

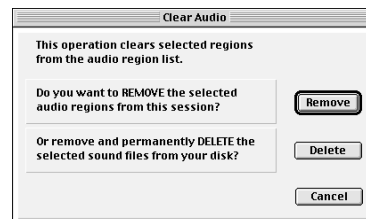

*Clear Selected dialog (audio regions)*

When clearing audio files for multiple regions, Pro Tools presents a warning dialog for each audio file. To bypass repeated warning dialogs:

- Option-click (Macintosh) or Alt-click (Windows) the Delete button in the Clear Audio dialog. This permanently deletes each successive audio file from your hard drive (for each of the unused regions) without any further warnings.

Use this “power delete mode” with care, since deletion of these files cannot be undone.

---

## Compacting an Audio File

In a disk-based recording and editing system such as Pro Tools, disk storage is at a premium. To help you get the most out of your storage, the Compact Selected command allows you to compact audio files by removing unused areas in order to conserve disk space. This is done by examining a selected source audio file and rewriting it to disk, irretrievably deleting any data that has not been defined as a region.

If you have auto-created regions hidden in your session, Pro Tools gives you the option of deleting any that are unused. If you choose to delete them, all unused auto-created regions are deleted at the same time.

- ▲ Because it permanently deletes audio data, this Compact Selected command should be used only after you have completely finished your editing and are sure that you have no further use for the unused audio data.

---

To ensure that you keep a particular auto-created region, you can turn it into a user-defined region by double-clicking it in the Regions List and entering a name.

The Compact Selected command allows you to “pad” the regions of the compacted file by a user-selectable amount. You may want to do this because Pro Tools requires extra audio data before and after audio regions in order to create crossfades. So, if your regions have crossfades, or if you want to pad the regions for the sake of any future trimming, you should enter an appropriate amount of padding (in milliseconds) to account for this.

---

- ▲ The Compact Selected command is destructive and cannot be undone! It permanently alters the original audio files. There is no way to recover data deleted with this command.

---

### To compact an audio file:

- 1 Choose Select Unused >Regions from the Audio Regions List pop-up menu. All regions that have not been placed in a track in the current session are highlighted in the Audio Regions List.
- 2 To remove all of these unused audio regions, choose Clear Selected from the Audio Regions List pop-up menu. When the dialog appears, choose Remove.
- 3 In the Audio Regions List, click on the region (or Shift-click to select multiple regions) that you want to compact.
- 4 Choose Compact Selected from the Audio Regions List menu.

**5** Enter the amount of padding in milliseconds that you want to leave around each region in the file.

**6** Click Compact to compact the file or Cancel to cancel the command.

Once the Compact operation has been completed, the session is automatically saved.

## chapter 16

# MIDI Editing

You can edit individual MIDI notes and controller events with the Pencil, Trimmer, and Grabber. You can also use the various MIDI Operations (Quantize, Transpose, Change Velocity, and Change Duration) to transform groups of MIDI notes to affect pitch, timing, and phrasing. For information on region-specific editing for both MIDI and audio, see *Chapter 15: Working with Regions and Selections*.

### Inserting MIDI Notes with the Pencil Tool

In addition to recording and importing MIDI into Pro Tools, you can manually insert MIDI notes with the Pencil tool.

#### To insert a MIDI note with the Pencil:

- 1 Set the MIDI track's Display Format to Notes.
- 2 Select the Pencil tool and make sure it is set to Freehand.



*Pencil tool set to Freehand*

- 3 Set the Time Scale to Bars:Beats. In addition, set the Edit mode to Grid and the Grid value to quarter notes (0|1|000).

With these settings, quarter notes will be inserted on the beat.

- 4 Move the Pencil into the playlist area for the MIDI track. Use the Edit window's Ruler and the track's mini-keyboard to locate the desired pitch and location.

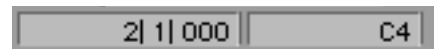

*Current Cursor display*

When using the Pencil, the Current Cursor display in the upper right of the Edit window provides feedback on its location.

- 5 When the desired pitch and location are located, click to insert the note.

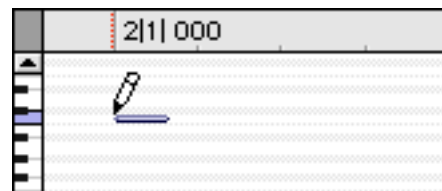

*MIDI note inserted with the Pencil*

The velocity for inserted notes is determined by the "Default Note On Velocity" setting in the MIDI Preferences. The duration of the note is determined by the Edit window's Grid value. If the MIDI Prefer-

ences option for “Play MIDI notes with Grabber and Pencil Tools” is enabled, each inserted note will sound.

The Pencil can be dragged after clicking (and before releasing) to adjust the note’s pitch or duration.

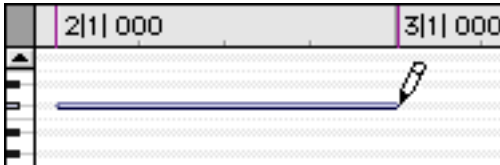

*Adjusting the duration for an inserted note*

Click and drag right to lengthen the note without changing its start point, click and drag left to lengthen the note without changing its end point.

---

\* With Grid mode enabled, Command-drag (Macintosh) or Control-drag (Windows) with the Pencil to snap the note’s end point to the nearest Grid boundary.

---

The Pencil tool shapes (Line, Triangle, Square, and Random) can be used to enter a series of identical pitches with varying velocities. The length and spacing for the inserted notes is determined by the current Grid value. The note velocities are determined by the Pencil shape.

#### **To insert a series of notes with random velocities:**

1 Set the MIDI track’s Display Format to Notes.

2 Select the Pencil tool and make sure it is set to Random.



*Pencil tool set to Freehand*

3 Set the Time Scale to Bars:Beats. In addition, set the Edit mode to Grid and the Grid value to quarter notes (0|1|000).

With these settings, the inserted notes will be spaced one quarter note apart.

4 Click at the point where the first note will be inserted and drag to the right.

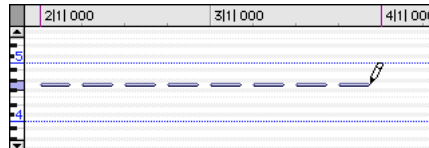

*Inserting a series of notes with the Pencil*

5 When the desired number of notes are visible, release.

Use the Square shape for alternating velocities of loud and soft. Use the Triangle shape for a ramp up and down of velocities. The Line shape enters notes with identical velocities.

---

## **Manually Editing MIDI Notes**

All aspects of a MIDI note can be edited from the Edit window, including start and end points, duration, pitch, and velocity. The Grabber and Selector can operate on individual notes or groups of notes.

## Selecting MIDI Notes

### To select a group of MIDI notes:

- With the Grabber, Shift-click each note.
  - or –
- With the Grabber, move the cursor to where there are no notes (the Marquee appears) and click and draw a rectangle around the group of notes.

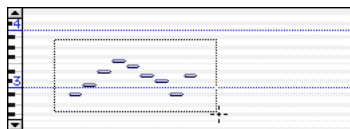

Selecting notes with the Grabber

When using the Grabber, if any portion of the rectangle touches a note (either its start or end point), the note is included in the selection. Selections made with the Grabber do not include underlying controller and automation data for the MIDI track.

- or –
- With the Selector, drag across a range of notes.



Selecting notes with the Selector

When using the Selector, a note's start point must be included in order for it to become selected. When a MIDI track is displaying notes (or regions), selections made with the Selector include underlying controller and automation data.

### To select a single pitch for the entire length of a track:

- On the mini-keyboard, Command-Shift-click (Macintosh) or Control-Shift-click the note.



Selecting a pitch from the mini-keyboard

### To remove one or more notes from a selection:

- With the Grabber, Shift-click the notes so they become deselected.

## Transposing Notes with the Grabber

MIDI notes can be transposed by dragging up or down with the Grabber. If several notes are selected before dragging, each is transposed.

### To transpose a MIDI note:

- 1 Set the MIDI track's Display Format to Notes.
- 2 Select the Grabber tool.
- 3 While pressing Shift, drag the note up or down.

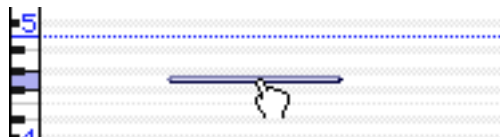

Transposing with the Grabber

The Shift key ensures that the transposed note retains its start point. While dragging, each new note sounds and the Current Cursor display indicates the number of semitones and direction (+/-) for the transpose.

---

\* To transpose a copy of the note, leaving the original unchanged, press Option (Macintosh) or Control (Windows) while dragging.

---

## Moving Notes with the Grabber

Like regions, MIDI notes can be dragged left or right with the Grabber to change their start point. If several notes are selected before dragging, each is moved.

### To move a MIDI note:

- 1 Set the MIDI track's Display Format to Notes.
- 2 With the Grabber, drag the note left or right (press Shift while dragging to preserve the note's pitch).

As the note is dragged, the Current Cursor display indicates the new start point.

If the Edit mode is set to Grid, the dragged note snaps to the nearest Grid boundary. If the Edit mode is set to Spot, the Spot dialog opens.

---

\* To copy the selected notes, leaving the originals intact, press Option (Macintosh) or Control (Windows) while dragging.

---

☞ The placement of MIDI notes can also be adjusted with Shift (see "Shift Command" on page 188) or Nudge (see "Nudging" on page 186).

---

## Trimming Note Start and End Times

Like regions, start and end points for MIDI notes can be adjusted with the Trimmer tool. If several notes are selected when performing the trim, each note is changed.

### To change the end points for a group of MIDI Notes:

- 1 Set the MIDI track's Display Format to Notes.
- 2 Using the Grabber, Shift-click each note you want to trim.
- 3 Select the Trimmer tool.



*Trimmer tool set to Standard*

---

▲ For TDM systems, make sure that the Standard Trimmer is selected in its pop-up menu.

---

- 4 Move the cursor near the end of any of the highlighted notes, so the Trim cursor appears. Drag left to shorten the notes, drag right to lengthen them.

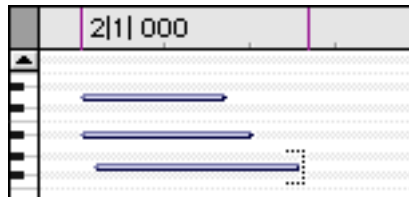

*Changing note end times with the Trimmer*

If using Grid mode, the dragged start/end point snap to the nearest Grid boundary. If using Spot mode, the Spot dialog opens, where you can enter the new location for the note's start or end point.

Notes can also be trimmed with the Trim To Selection command (see "Trim To Selection Command" on page 177) and the Trim To Insertion command (see "Trim To Insertion Command" on page 181).



## Manually Editing Note Velocities

When a MIDI track's Display Format is set to Velocity, each note's attack velocity is represented with a velocity stalk. The taller the velocity stalk, the higher the velocity value (0-127).

### To edit a velocity stalk with the Grabber:

- 1 Set the MIDI track's Display Format to Velocity.
- 2 Select the Grabber tool.
- 3 Drag the top (diamond) of the velocity stalk up or down.

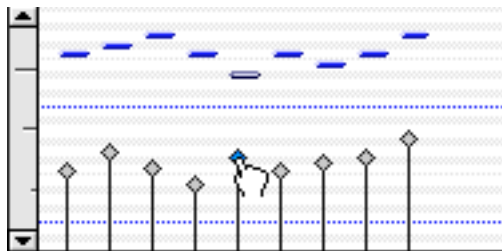

*Dragging a velocity stalk*

– or –

If two notes have the same start time (with velocity stalks on top of each other), Command-drag (Macintosh) or Control-drag (Windows) the actual note up or down.

Drag up to increase the velocity value, down to decrease it. While dragging, the diamond turns blue and the associated note becomes selected. The dragged velocity values are reflected in the Current Cursor display.

The velocities for a range of notes can be edited with the Pencil tool, either by Free-hand or with any of the Pencil tool shapes.

### To draw velocity values that fade in:

- 1 Set the MIDI track's Display Format to Velocity.
- 2 Select the Pencil tool with the shape set to Line.
- 3 Click at the beginning of the note range, near the bottom of the velocity range, and drag to the right and up.

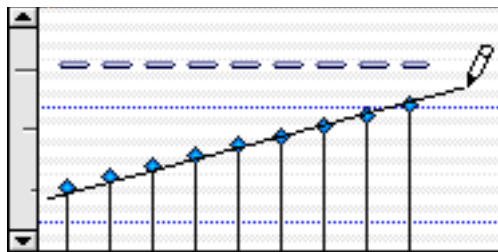

*Changing velocities with the Line shape*

- 4 Once the line encompasses the desired range of notes, along with the desired steepness of the fade, release.

You can also use the Trimmer tool to scale the velocities for all selected notes. This is useful if you like the velocity relationship between the notes, but want them to be louder or softer.

### To scale velocities with the Trimmer:

- 1 Set the MIDI track's Display Format to Velocity.
- 2 Using either the Selector or Grabber, select the range of notes to be edited.
- 3 With the Trimmer, click near the range of selected notes and drag up or down. Dragging up boosts the velocities for each note, dragging down reduces them.

## Typing in Note Attributes

When an individual note is selected with the Grabber, its attributes are displayed in the Event Edit area.

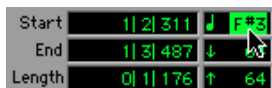

*Event Edit Area, Pitch attribute selected*

Pitch is listed by note name and octave number. Attack and release velocities are listed with their MIDI values (0-127). Times for Start, End, and Length are displayed in the Main Time Scale.

### To change an attribute for a MIDI note:

- 1 In the MIDI track's playlist area, select the note with the Grabber.
- 2 Click in the Attribute's text box.
- 3 Type in the new value for the note and press Enter.  
– or –

With the pitch or velocity fields selected, play a note on your MIDI controller to automatically update the value. If the track is record-enabled, the new value is heard. Press Enter to accept the new value.

Press the slash key to move between the fields in the Event Edit area.

### Multiple Notes and Event Edit Area

When multiple notes are selected, you can enter values in the Event Edit area fields to affect all selected notes.

A new value in the Start field moves the first note in the selection to that location, with all other notes moving with it.

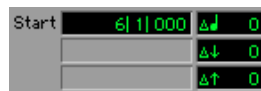

*Multiple notes in the Event Edit area*

Values entered in the pitch and velocity fields add to or subtract from the values for all selected notes. For instance, to transpose all selected notes down an octave, enter a value -12 for pitch.

## Deleting MIDI Notes

In addition to deleting selected notes with the Clear command in the Edit menu, individual notes can also be deleted with the Pencil tool.

### To delete a group of MIDI notes with the Clear command:

- 1 With the Grabber or Selector, select the notes to be deleted. For details, see “Selecting MIDI Notes” on page 203.
- 2 Choose Edit > Clear to delete the selected notes.

---

▲ When deleting notes selected with the Selector, all underlying controller and automation data is also deleted.

---

### To delete a single MIDI note with the Pencil:

■ With the Pencil tool selected, press Option (Macintosh) or Alt (Windows) so the tool changes to an Eraser, then click the note to delete it.

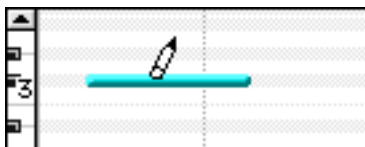

*Deleting a note with Pencil*

\* Program change events and sysex events can also be deleted by Option-clicking (Macintosh) or Alt-clicking (Windows) them with the Pencil tool.

## Continuous Controller Events

Continuous controller events for MIDI tracks are displayed in the form of a line graph with a series of editable breakpoints. Controller events for MIDI tracks differ somewhat from automation data for audio tracks in that the breakpoints are stepped (instead of vector-based), where each breakpoint represents a single controller event.

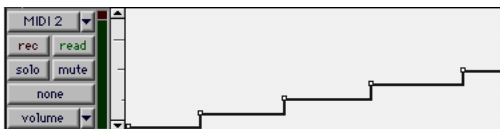

*MIDI track displaying volume events*

Continuous controller events that can be inserted and edited in Pro Tools include:

- volume
- pan
- pitch bend
- aftertouch (mono)
- MIDI controllers, 0–127

▲ While polyphonic aftertouch can be recorded into Pro Tools, it cannot be viewed or edited.

MIDI controller #7 (volume) and #10 (pan) are treated by Pro Tools as automation data. This means that these controller events (along with Mutes) can be recorded and automated from the Mix window; in addition, each MIDI track's automation mode affects how these events are played back and recorded.

While a MIDI track's volume and pan (and mute) events can be suspended, all other controller events in the track always play.

Continuous controller events (including volume and pan) can be recorded from an external MIDI controller (such as a keyboard or control surface), and they can be inserted in a MIDI track's playlist with the Grabber or Pencil.

## Inserting/Editing Controller Events

Continuous controller events can be edited with any of the following methods:

- ◆ Individual breakpoints can be dragged with the Grabber to adjust their location or value.
- ◆ A group of selected breakpoints can be scaled up or down with the Trimmer.
- ◆ New controller events can be drawn in with the Pencil tool to replace existing events. Events can be drawn with the Pencil set to Freehand, or using any of the shapes (Line, Triangle, Square, or Random).
- ◆ Controller events can be copied and pasted, nudged, and shifted.

For details on these editing procedures, see *Chapter 21: Automation*.

---

\* Edits to volume data affect all tracks within an enabled Edit Group. This is not the case, however, for other controller playlists (such as pan). To insert and edit other controller types across all tracks in an Edit Group, press Control (Macintosh) or the Start key (Windows) while performing the edits.

---

## Resolution for Inserted Controller Events

When inserting controller events with the Pencil, the density of the events is determined by the MIDI Preference for “Pencil Tool Resolution When Drawing Controller Data.”

### To set the Pencil tool resolution:

- 1 Choose Setups > Preferences and click MIDI.

- 2 Enter a value for “Pencil Tool Resolution When Drawing Controller Data.” The value range is from 1 to 100 milliseconds.

- 3 Click OK.

---

## Program Changes

Each MIDI track can have a default program change that is sent each time the track plays. Additional program changes can be inserted at any point within the track.

### About Program and Bank Changes

The MIDI protocol lets you choose from a range of 128 programs (0-127). Most MIDI instruments have several banks of 128 programs. To specify which bank you’re selecting from, a *bank select* message must be sent. Some instruments use Controller 0 to switch the bank while others use Controller 32 (some use a combination of the two). The Program Change window in Pro Tools allows you to use either of these bank select messages when inserting a program change event. Check with the manufacturer’s documentation to see which message your device uses.

---

\* Some older MIDI devices (such as the Kurzweil K1000) use a program change instead of a Bank Select message to switch banks. For these devices you may find it necessary to send two program change messages to access a particular program, where the first sets the bank and the second sets the program.

---

## OMS Patch Names

### (Macintosh Only)

If your MIDI devices are subscribed to OMS patch names, these names will appear in the Program Change window in Pro Tools, and also in the inserted program change events. If not, programs will be selected and viewed by number.

For details on using the OMS Name Manager, refer to the online *OMS Manual* included on the Pro Tools CD-ROM.

## Default Program Change

The default program change for each MIDI track is specified by clicking on the Program button, from either the Edit or Mix window. Once specified, the default program change message is sent to your instrument when playing the track.

### To set the default program change for a MIDI track:

- 1 From the Edit or Mix window, click on the Program button.



Program button

#### Program button, Edit window

The Program button in the Edit window (if the Track Height is set to Medium or Larger) displays the name of the default program, or “none” if one has not yet been specified. The Program button in the Mix window (and in the Edit window when the Track Height is set to Small), is labeled as “p.”

- 2 In the Program Change window, select a program number (or name) and, if necessary, specify a bank change value.

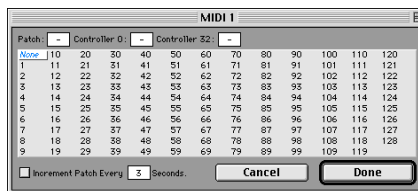

#### Program Change window

- 3 Click Done.

Once selected, the program number (or name) appears in the Program button in the Edit window. To clear the default program change, select None in the Program Change window.

Unlike recorded and inserted program change events, the default program change does not appear in the track's playlist.

## Inserting/Editing Program Changes

Program changes can be inserted into a track's playlist with the Pencil tool. Existing program changes can be edited, moved, and copied and pasted.

\* On some instruments, changing programs during playback can interrupt playback. To avoid this, place program change events in the track where there are no notes sounding.

### To insert a program change with the Pencil:

- 1 Set the MIDI track's Display Format to Program.
- 2 If desired, set the Edit mode to Grid so the inserted event snaps to the Grid.
- 3 Click with the Pencil in the track's playlist at the point where you want to insert the program change.
- 4 In the Program Change window, select a program number (or name) and, if necessary, specify a bank change value.
- 5 Click Done to insert the program change event in the track's playlist.



*Program change event*

### To edit a program change event:

- 1 With the Grabber, double-click the program change event you want to edit.
- 2 In the Program Change window, select the new program number (or name) and, if necessary, specify a bank change value.
- 3 Click Done.

### To move a program change event:

- With the Grabber, drag the program change event left or right.

If the Edit mode is set to Grid, the dragged event snaps to the nearest Grid boundary. If the Edit mode is set to Spot, the Spot dialog opens.

---

☞ The placement of program changes can also be adjusted with Shift (see “Shift Command” on page 188) or Nudge (see “Nudging” on page 186).

---

### To delete a program change event:

- 1 With the track's Display Format set to Notes, click on the program change event with the Grabber to select it.

– or –

If the region contains other events you want to delete, select the entire region with the Grabber (when the track is displaying regions).

- 2 Choose Edit > Clear to remove the selected events from the track.

---

\* Individual program change events can also be deleted by Option-clicking (Macintosh) or Alt-clicking (Windows) them with the Pencil.

---

## Auditioning Programs

When the Program Change window is open, you can have Pro Tools automatically scroll through the different patches for a track's assigned MIDI device.

### To audition patches from the Program Change window:

- 1 To audition patches for a MIDI track while it plays, click Play in the Transport window.
- 2 Open the Program Change window by clicking the Program button in the Mix window, or by inserting or editing a program change event in a MIDI track.

**3** Click on a program number—the starting point from which you will scroll through the patches.

**4** If desired, enter a value for the number of seconds that will elapse between each program change.

**5** Select the option for Increment Patch.

After the specified number of seconds, Pro Tools selects the next patch and transmits the program change to the track's assigned MIDI device. As desired, play your MIDI controller to audition the new patches.

---

## System Exclusive Events

System Exclusive (sysex) events can be recorded to MIDI tracks in Pro Tools (see “Recording System Exclusive Data” on page 112). Once the events are recorded, they appear in the track's playlist as blocks when the Display Format is set to Sys Ex.



*Sysex event block*

While the contents of recorded System Exclusive events cannot be directly edited in Pro Tools, the events can be moved or nudged, copied and pasted, or deleted.

### To move a sysex event:

- 1** Set the MIDI track's Display Format to Sys Ex.
- 2** With the Grabber, click on the region and drag left or right.

If the Edit mode is set to Grid, the dragged event snaps to the nearest Grid boundary. If the Edit mode is set to Spot, the Spot dialog opens.

---

☞ The placement of sysex event blocks can also be adjusted with Shift (see “Shift Command” on page 188) or Nudge (see “Nudging” on page 186).

---

### To delete one or more sysex events:

- 1** With the track's Display Format set to Sys Ex, click on the sysex event with the Grabber to select it.

– or –

If the region contains other sysex events you want to delete, select the entire region with the Grabber (when the track is displaying regions).

- 2** Choose Edit > Clear to remove the selected events from the track.

---

\* Individual sysex event blocks can also be deleted by Option-clicking (Macintosh) or Alt-clicking (Windows) them with the Pencil tool.

---

---

## MIDI Operations Window

The MIDI Operations window opens when choosing any of the following commands from the MIDI menu:

- Quantize
- Change Velocity
- Change Duration
- Transpose
- Select Notes
- Split Notes
- Input Quantize

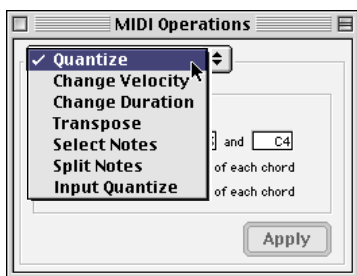

Figure 12. MIDI Operations window

To reconfigure the MIDI Operations window for a different command, select the command from the MIDI menu or from the pop-up menu at the top of the window (see Figure 12).

The MIDI Operations window can be left open as desired, revisiting it as necessary to invoke a command, or to try out different options for a particular command.

### To show or hide the MIDI Operations window:

- Choose Windows > Show MIDI Operations.

### To invoke the command in the MIDI Operations window:

- Click Apply or press Enter on the numeric keypad. This invokes the command and leaves the window in the foreground.  
– or –

Press Return (Macintosh) or Enter on the alpha keyboard (Windows). This invokes the command and moves the window to the background.

### To undo the command in the MIDI Operations window:

- Choose Edit > Undo.

## Options in the MIDI Operations Window

Use the following methods to easily configure the various options, which vary from command to command, in the MIDI Operations window:

- ◆ To move forward and back through the various fields, press Tab or Shift+Tab.
- ◆ Increment or decrement selected fields with the Up/Down Arrows. Press and hold these keys to scroll quickly through the values.
- ◆ Press Command (Macintosh) or Control (Windows) while adjusting sliders for finer resolution.
- ◆ For selected pitch and velocity fields, play a note on your MIDI controller to automatically enter it.
- ◆ Changing a value for a particular parameter (such as the Swing Percentage in the Quantize window), automatically enables the parameter.



---

## Select Notes

The Select Notes command allows you to further narrow a selection of MIDI notes based on pitch. The command can be used to select a single note or note range for the entire length of a region or track, or to select the upper or lower voices within chords.

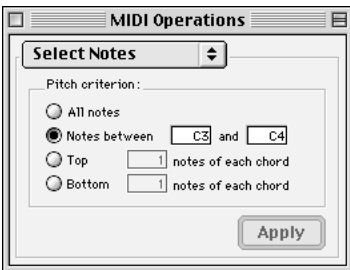

Select Notes window

Options for the Select Notes command include:

**All Notes** All notes are selected.

**Notes Between** Selects a range of notes between the specified upper and lower note. Values for the notes can be entered in pitch (C-1–G8) or MIDI note numbers (0–127).

**Top** Selects the highest note or notes in each chord.

**Bottom** Selects the lowest note or notes in each chord.

### Selecting a Pitch Range of Notes

A common use for Select Notes is to select a single note for the entire length of a region or track. This is especially useful if you want to select a note in a MIDI drum track

(hi-hat, for instance), and affect it over the selected time range with the Quantize, Transpose, or Change Duration command.

### To select only the hi-hats in a General MIDI drum track:

- 1 Using the Grabber or Selector, select the range of MIDI notes that contains the note.
- 2 Choose MIDI > Select Notes.
- 3 Select the Notes Between option with the note range set to F#1 and F#1.

For a General MIDI drum kit, the closed hi-hat is assigned to F#1 (MIDI note number 42). If the hi-hat for your drumkit is assigned to a different note, make sure to specify it.

- 4 Click Apply.

### Selecting Notes in a Chord

Another use for Select Notes is to select only the upper or lower notes in a chord. Many times you'll want to affect only the upper or lower notes in a chord—to boost their velocities, or transpose their pitch.

### To select only the bass notes in a chord:

- 1 Using the Grabber or Selector, select the range of MIDI notes that contains the chords.
- 2 Choose MIDI > Select Notes.
- 3 Select the Bottom option and leave the number of notes set to 1.
- 4 Click Apply.

---

▲ In order for notes to be considered a chord, their start times must be within five ticks of each other.

---

## Split Notes

The Split Notes command has the same selection criteria as the Select Notes command, but also lets you automatically cut or copy the selected notes when clicking Apply.

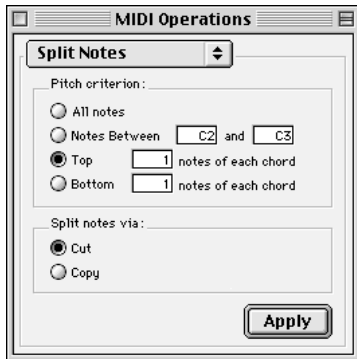

*Split Notes window*

One use for this command would be if you recorded a track with chords in the left hand and melody in the right. With the Split Notes command, you could cut the melody notes and paste them to another track so you could assign them to play on a different device or channel. Another use is to split the various notes (kick, snare, toms etc.) from a single drum track to separate tracks.

### To cut a specific pitch range of notes:

- 1 Using the Grabber or Selector, select the range of MIDI notes that contains the notes.
- 2 Choose MIDI > Split Notes.
- 3 In the Split Notes dialog, select the option for Notes Between and enter the low and high notes for the pitch range.

When the either of the Pitch fields are selected, you can play a pitch on your MIDI controller to automatically enter it.

- 4 Click Apply. Notes falling within the specified pitch range are removed from the selection and placed on the Clipboard. The notes can then be pasted or merged to another a track.

---

## Quantize

The Quantize command adjusts MIDI note locations and durations so that timing is improved, or so that a particular rhythmic “feel” is achieved. Quantize works by aligning notes to a Quantize Grid, the size of which is defined in the Quantize window by a standard note duration.

The Quantize command is not the same as the Quantize Regions command (in the Edit menu). The Quantize Regions command adjusts the start point for a selected region, and its contents are moved along with the region (with rhythmic relationships remaining intact).

The Quantize command, on the other hand, affects MIDI notes individually. Some notes may be moved back in time, others forward; and, some notes will be more drastically affected than others.

---

\* The settings in the Quantize window are saved with each session. To store your favorite settings as the default for use in future sessions, save them as part of a session template (see “Creating Custom Session Templates” on page 48).

---

To open the Quantize window, choose MIDI > Quantize. Each of the Quantize options is discussed in the following sections.

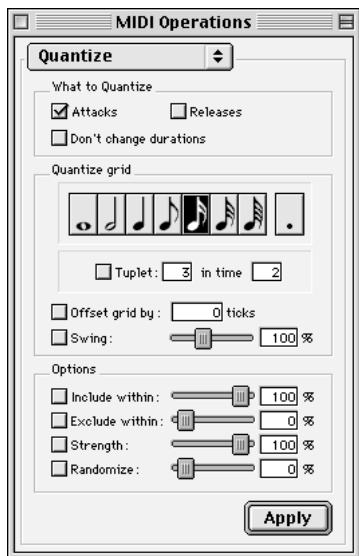

Quantize window

## What to Quantize

The options under “What to Quantize” determine which aspects of the notes are quantized: attacks, releases, or both.

**Attacks** When selected, note start points are quantized.

**Releases** When selected, note end points are quantized.

**Don't Change Durations** When deselected with the Attacks option selected, note end points are not moved. When deselected with the Releases option selected, note start points are not moved.

If the options for both Attacks and Releases are selected, the Don't Change Durations option is ignored (and dimmed).

Figure 13 shows how notes are adjusted by the different What To Quantize options.

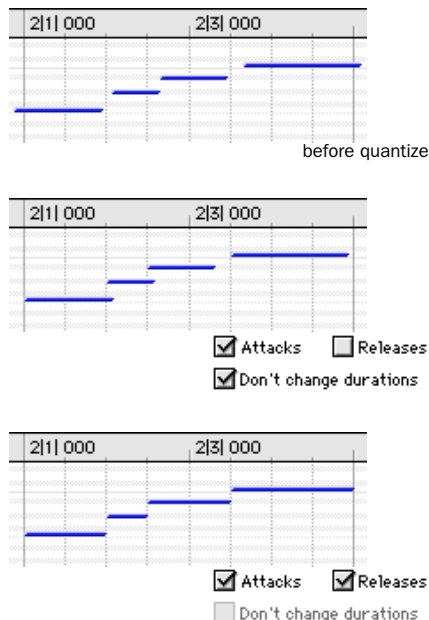

Figure 13. What To Quantize examples

## Quantize Grid

The Quantize Grid determines the beat boundaries to which notes are aligned. Any size from whole notes to thirty-second notes (including dotted values) can be selected for the grid size.

**Tuplet** Select the Tuplet option to quantize irregular note groupings like triplets or quintuplets. The Quantize Grid for triplets is calculated from the note size selection and the Tuplet value. For instance, if an eighth note equals 480 ticks, triplet eighth notes with 3 in time of 2 would yield a grid size of 320 ticks (480 ticks / 3 \* 2).

**Offset Grid By** Offsets the Quantize Grid forward or back in time by a specified number of ticks. Use this option to achieve a pushed (positive values) or laid back (negative values) feel.

\* To Quantize just the backbeats, set the Quantize Grid to half-notes with an Offset of 960 ticks.

**Swing** When selected, every other grid boundary is shifted by the specified percentage value (0-300) to achieve a “swing” feel. A Swing value of 0% yields no swing, while 100% yields a triplet feel. With Swing set to 300%, every other grid boundary is moved to the next grid point.

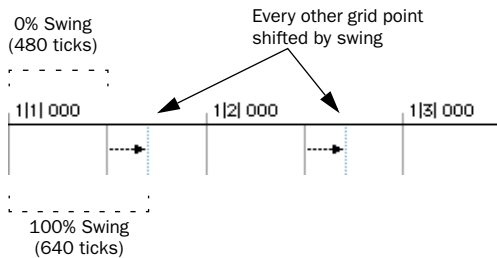

100% Swing, eighth note grid

## Quantize Options

Additional Quantize options include:

**Include Within** When selected, attacks and releases are only quantized if located within the specified percentage of the Quantize Grid. Use this option to clean up downbeats without affecting notes that are “swung” or wildly off the beat.

Figure 14 shows the Quantize Grid set to quarter notes with the Include Within option set to 50%. Only attacks and releases

falling within the shaded area (equivalent to an eighth note area around each beat) are quantized.

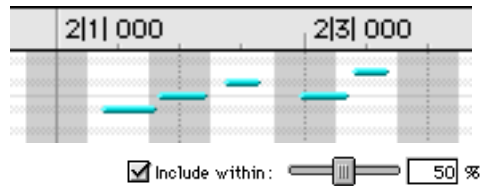

Figure 14. Include Within option

**Exclude Within** When selected, attacks and releases are not quantized if located within the specified percentage of the Quantize Grid. Use this option to preserve the feel of notes close to the beat, while correcting others that are drastically away from the beat.

Figure 15 shows the Quantize Grid set to quarter notes with the Exclude Within option set to 25%. Attacks and releases falling within the shaded area (equivalent to a sixteenth note area around each beat) are not quantized.



Figure 15. Exclude Within option

**Strength** When selected, notes are moved a percentage toward the Quantize Grid. Lower percentages preserve the original feel of the notes, higher percentages align the notes more tightly to the grid.

**Randomize** When selected, notes are moved randomly forward or back in time (after the Quantize occurs). For instance, with the Quantize Grid set to eighth notes and Randomize set to 50%, notes are placed up to a 32nd note before or after the beat boundary. The Randomize setting also affects note durations (if Releases is selected).

## Quantize Examples

The following examples illustrate some of the more common uses for the Quantize command.

If you intend to loop playback while quantizing, you may want to deselect Operations > Link Edit and Timeline Selection. This ensures that the play range will not change when selected notes are moved in the course of quantizing and undoing.

---

▲ While you can undo a Quantize operation, the Quantize command is destructive and permanently affects selected data. To preserve existing data, duplicate the playlist before quantizing.

---

## Straight Quantize

**To quantize to a straight sixteenth note feel:**

- 1 Select the range of MIDI notes to be quantized.
- 2 Choose MIDI > Quantize.
- 3 Under What to Quantize, select the Attacks option. To quantize note durations as well, select the Releases option.

4 Set the Quantize Grid to sixteenth notes. Make sure that the other options for Tuplet, Offset Grid By, and Swing are not selected.

5 Leave the remaining Quantize options deselected and click Apply.

## Quantizing while Preserving the Original “Feel”

You can quantize less strictly, to preserve the original feel of your recorded MIDI tracks:

**To quantize while preserving the original feel:**

- 1 Select the range of MIDI notes to be quantized.
- 2 Choose MIDI > Quantize.
- 3 Under What to Quantize, select the Attacks option. To quantize note durations as well, select the Releases option.
- 4 Set the Quantize Grid to the desired note size. Make sure that the other options for Tuplet, Offset Grid By, and Swing are not selected.
- 5 Select the Exclude Within option with a value of 10-15%.
- 6 Select the Strength option with a value of 70-80%.
- 7 Leave the remaining Quantize options deselected and click Apply.

Audition the change and if the desired effect is not achieved, undo the edit and experiment with different values for Exclude Within and Strength.

## Quantizing with Swing

If you're working with hi-hats or bass lines, you may want to apply more of a swing feel to the track.

### To quantize with an eighth note swing feel:

- 1 Select the range of MIDI notes to be quantized.
- 2 Choose MIDI > Quantize.
- 3 Under What to Quantize, select the Attacks option. To quantize note durations as well, select the Releases option.
- 4 Set the Quantize Grid to eighth notes.
- 5 Select the Swing option with the desired Swing percentage:
  - For a light swing, use 12%.
  - For a tighter swing-like groove, use 24%.
  - For a true “triplet-like” swing feel, use 50–75%.
- 6 Make sure the options for Tuplet, Offset Grid By, and Randomize are not selected. Click Apply.

Audition the change and if the desired effect is not achieved, undo the edit and experiment with a different Swing percentage.

## Quantizing with Randomize

You may find that after quantizing, notes sound too mechanical, too “on the beat.” You can use the Randomize option in the Quantize window to make them sound more natural.

### To humanize the rhythmic feel of notes:

- 1 Select the range of MIDI notes to be quantized.
- 2 Choose MIDI > Quantize.
- 3 Under What to Quantize, select the Attacks option. To quantize note durations as well, select the Releases option.
- 4 Set the Quantize Grid to the desired note size.
- 5 Select the Randomize option with a value of 5%.
- 6 Click Apply.

Audition the change and if the desired effect is not achieved, undo the edit and experiment with a different Randomize percentage.

## Experimenting with Quantize

When using the Quantize command, you'll often have to experiment with many of the parameters. In fact, you won't always get the results you're expecting. You may have to try different values for Include and Exclude Within, and Strength; these parameters determine which notes are affected and how drastically they are changed. In addition, the Randomize parameter, which adds a percentage of randomness to the quantize, can be used to make tracks feel less mechanical—less perfect.

Although quantize is a wonderful tool for cleaning up tracks and playing with the feel of your music, sometimes the recorded data may not be salvageable. In these instances it is wise not to spend too much time trying to fix something that should probably just be rerecorded.

---

## Change Velocity

The Change Velocity command automatically adjusts attack and release velocities for selected MIDI notes. Use it to make notes louder or softer, or to create crescendos or decrescendos.

Velocities can also be edited manually with the Pencil and Grabber Tools (see “Manually Editing Note Velocities” on page 205).

---

\* Velocity values usually affect the loudness of MIDI notes. They may also affect other aspects of an instrument’s sound, such as filter cutoff, envelopes, and modulations.

---

\* The settings in the Change Velocity window are saved with each session. To store your favorite settings as the default for use in future sessions, save them as part of a session template (see “Creating Custom Session Templates” on page 48).

---

To open the Change Velocity window, choose MIDI > Change Velocity. Options for the Change Velocity are discussed in the following section.

While there are options for adjusting both the attack and release velocities for notes, most MIDI devices ignore release velocity information. To see if your instrument supports release velocities, refer to the manufacturer’s documentation.

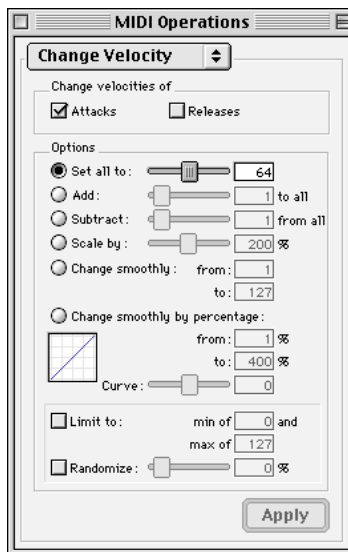

*Change Velocity window*

**Set All To** Sets all velocities to the specified value (1–127).

**Add** Adds to existing velocity values by the specified amount (1–127).

**Subtract** Subtracts from existing velocity values by the specified amount (1–127).

**Scale By** Scales all velocities by a percentage amount (1–400%).

**Change Smoothly** Allows velocities to change smoothly from one value to another over time.

**Change Smoothly by Percentage** Allows velocities to change smoothly from one percentage value to another over time.

The curve for this change can be adjusted (+/– 99) to affect how gradually the change occurs.

**Limit To** When selected, restricts the Change Velocity command to a minimum and maximum range.

**Randomize** When selected, the Change Velocity command is randomized by the specified percentage value. For instance, using “Set all to” with a value of 64, along with a Randomize value of 50%, yields velocities anywhere between 48 and 80 (+/- 25% of the velocity value).

## Velocity Ranges

The valid range for MIDI note velocities is 1–127. The Change Velocity command will never result in moving velocities outside this range; 1 will always be the lowest and 127 will always be the highest. This means that you may reach a state where the Change Velocity command has no effect on a particular note.

For instance, if a note with a velocity of 64 is scaled by 200%, the new velocity would be 127. Attempting to scale or increase the velocity any further would yield no change.

## Fading Velocities

An interesting musical effect is when velocities get gradually louder or softer over time. This can be used to make notes fade in or out, or to provide timbral variations in the way that a MIDI instrument sounds.

### To change velocities smoothly over time:

- 1 Select the range of MIDI notes to be edited.
- 2 Choose MIDI > Change Velocity.
- 3 Select the Change Smoothly option with the range set from 127 to 0.
- 4 Click Apply.

To preserve (somewhat) the existing velocity relationships and still achieve velocity fades, use the option for Change Smoothly by Percentage. Figure 16 illustrates the difference between the two Change Smoothly options.

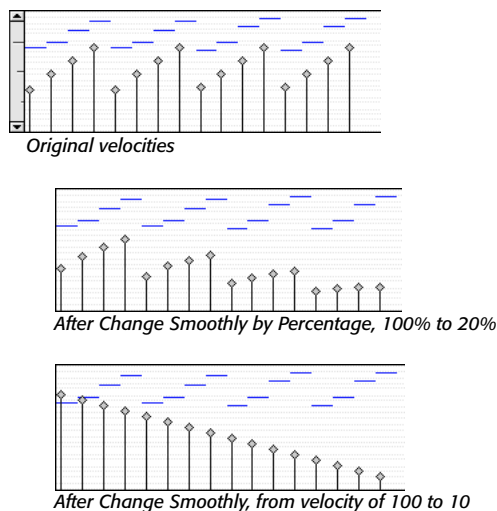

Figure 16. Change Smoothly/by Percentage

## Scaling Velocities

Many times existing note velocities will have the desired relationship between each other, but will either be too soft or too loud as a whole. In these instances, use the Scale By option.

### For instance, to make velocities 20% louder:

- 1 Select the range of MIDI notes to be edited.
- 2 Choose MIDI > Change Velocity.
- 3 Select the Scale By option with the percentage value set to 120.
- 4 Click Apply.



---

## Change Duration

The Change Duration command adjusts durations for selected MIDI notes. Use it to make melodies and phrases more staccato or detached, or more legato.

\* The settings in the Change Duration window are saved with each session. To store your favorite settings as the default for use in future sessions, save them as part of a session template (see “Creating Custom Session Templates” on page 48).

To open the Change Duration window, choose MIDI > Change Duration. Each of the Change Duration options is discussed in the following section.

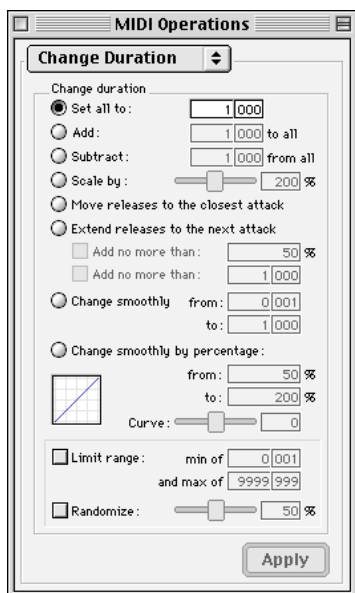

*Change Duration window*

**Set All To** Sets all durations to a length specified in quarter notes and ticks.

**Add** Adds to the durations by a specified number of quarter notes and ticks.

**Subtract** Subtracts from the durations by a specified number of quarter notes and ticks.

**Scale by** Shortens or lengthens durations based on a percentage value (1–400%).

**Move Releases to the Closest Attack** Shortens or lengthens durations so that end times are moved to the closest attack.

**Extend Releases to the Next Attack**

Lengthens durations so that end times are extended to the next attack. To limit the duration change, select either of the Add No More Than options, using either a percentage value or a number of quarter note and ticks.

**Change Smoothly** Allows note lengths to change smoothly from one duration to another over time. Duration values are specified in quarter notes and ticks.

**Change Smoothly by Percentage** Allows note lengths to change smoothly from one percentage value to another over time.

The curve for this change can be adjusted (+/– 99) to affect how gradually the change occurs.

**Limit Range** When selected, restricts the Change Duration command to a minimum and maximum range (in quarter notes and ticks).

**Randomize** When selected, the Change Duration command is randomized by the specified percentage value. For instance, using “Set all to” with a value of 480 ticks,

along with a Randomize value of 50%, yields durations anywhere between 360 and 600 (+/- 25% of the duration value).

## Change Duration Examples

### To make notes more staccato:

- 1 Select the range of MIDI notes to be edited.
- 2 Choose MIDI > Change Duration.
- 3 Select the option for Scale By with a percentage value of 50.
- 4 Click Apply. The durations for the selected notes are reduced by 50%.

With this option you may have to experiment with the percentage value to achieve the desired effect.

### To make notes more legato:

- 1 Select the range of MIDI notes to be edited.
- 2 Choose MIDI > Change Duration.
- 3 Select the option "Extend Release to the Next Attack."
- 4 Click Apply. The end points for the selected notes are extended to the start points of the next note, thereby eliminating the space between each note.

To vary this effect, making it more or less legato, select the Add No More Than percentage option. Percentage values larger than 100 extend note end times so that the notes essentially overlap.

---

## Transpose

While the Grabber Tool can be used to manually transpose individual MIDI notes, or small groups of notes, the Transpose command can be used for entire MIDI tracks and regions.

To open the Transpose window, choose MIDI > Transpose.

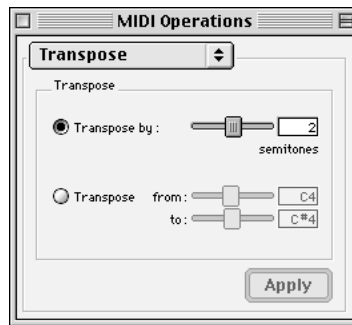

*Transpose window*

The two options for the Transpose command are:

**Transpose by Semitones** Transposes chromatically, up or down, by up to 60 semitones. To transpose down by an octave, for instance, use -12 semitones.

**Transpose From – To** Transposes by semitones, as expressed by the difference between the source and destination pitches. Transposing from C4 to C#4, for instance, transposes the notes up by one semitone.

One of the more common uses for Transpose is to change the key for your MIDI tracks. You can define an Edit Group for

MIDI tracks that want to transpose, making sure to exclude any drum tracks from the group so they aren't transposed.

**To transpose MIDI notes to another key:**

- 1 If you will be transposing a group of tracks, make sure to enable the Edit Group.
- 2 With the Selector or Grabber, select the range of MIDI notes to be transposed.
- 3 Choose MIDI > Transpose.
- 4 Select the option for Transpose From–To.
- 5 Set the “From” and “To” values, for instance, to C4 and E4 to transpose from C Major to E Major.

With either of the pitch fields selected, you can play a note on your MIDI controller to automatically enter it as the pitch value.

- 6 Click Apply.

It is also common to transpose MIDI tracks up or down by an octave.

**To transpose a MIDI track up by an octave:**

- 1 With the Selector, triple-click in the track to select all of its notes.
- 2 Choose MIDI > Transpose.
- 3 Select the Transpose By option.
- 4 Enter a value of 12 semitones and then click Apply.

---

## Note/Controller Chasing

*Note chasing* allows long, sustained MIDI notes to be heard when playing from a point after their start time. For instance, if a note's start time is at 1|1|000 and lasts for 8 measures (until 9|1|000), note chasing lets you begin playing from bar 5 and still hear the note that started at 1|1|000 as it continues to sustain until 9|1|000.

Note Chasing is something that can be turned on and off individually for each MIDI track. By default, new MIDI tracks have Note Chasing enabled.

**To enable Note Chasing for a MIDI track:**

- Click on the track's Playlist Selector and select the option for Note Chasing.



*Note Chasing enabled in Playlist Selector pop-up*

Make sure to disable Note Chasing when working with samplers that are playing loops. If a MIDI track, for instance, is triggering a 4-bar drum loop and you begin playing at bar 3, the loop will begin playing at the wrong time and be out of sync with the other tracks.

## Controller and Program Chasing

Pro Tools always chases continuous controller events and program changes for MIDI tracks. This ensures that controller values and patches for MIDI devices are always appropriately set.

For instance, suppose a MIDI track lasting 32 measures starts out with a volume of 127 and in the last bar fades the volume down to 0. If after playing the track in its entirety you attempt to play from bar 8, the initial volume of 127 is chased and sent to the track's assigned device—otherwise the track would not be heard since the most recent volume event sent would have been 0.

Chasing also occurs for a MIDI track's default program changes, along with any program change events residing within the track. Therefore, if you have chosen a default program change for a track, when playing from any point within the track, the program change event is sent to the track's assigned device.

### **Default Controller Values and Chasing**

Though new MIDI tracks appear to have default values for continuous controller playlists, this is actually not the case. For instance, when viewing a MIDI track's Mod Wheel playlist, you'll see that the breakpoint line is set to a default of zero. However, since the modulation wheel on your synth may purposely be set to a different value, the default value in the track is not transmitted when playing.

This can cause some confusion, however, if you insert a fade (for instance, from 0–90) in the Mod Wheel playlist towards the end of the track. If you then play from the beginning of the track, or from anywhere before the fade, the Mod Wheel value on your synth will be at 90 until the beginning of the fade data is reached—which is likely not what you want.

To ensure that the default controller value for a playlist is sent (and chased), click on the initial breakpoint at the beginning of the track, move it slightly, and set it back to the default value.

---

## **MIDI Offset**

Pro Tools offers a MIDI offset preference that allows MIDI tracks to play back earlier (than audio tracks) by a specified number of samples. The offset affects playback only and does not alter in any way how MIDI data is displayed in the Edit window.

This capability is provided in large part to compensate for the audio monitoring latency in Pro Tools LE. If you are monitoring the output of your MIDI devices with an external mixer or sound system (or headphones), there is no latency. If, however, you are monitoring the output of your MIDI devices through a Digi 001 (or Audiomedia III), your MIDI tracks will appear to play slightly later than your audio tracks. The larger the setting for the Hardware Buffer Size (128, 256, 512, or 1024 samples), the larger the latency.

By configuring a MIDI offset, you can get your MIDI tracks to play back slightly earlier (by a specified number of samples), thereby compensating for the latency in monitoring audio within Pro Tools LE.

### **To configure the MIDI offset in Pro Tools:**

- 1** Choose Setups > Preferences and click MIDI.
- 2** For the “Negative MIDI Playback Offset” option, enter the number of samples (up to 10000) for the offset.

In general, you should set the offset to a value that is roughly equivalent to the Hardware Buffer Size.

- 3** Click Done.

### **MIDI Offsets to Compensate for Slow MIDI Devices**

The MIDI offset in Pro Tools can also be used to compensate for delays in MIDI devices (i.e. the time it takes to trigger events on a sampler or synth).

For instance, if you have some kick drums that are being played by an audio track in Pro Tools and want them to be perfectly “in sync” with kick drums that are being played by a MIDI device, you may need to use a MIDI offset. In this instance, it will usually take at least 5 ms to trigger the MIDI notes, and it could take even longer, depending on the MIDI device.

You can measure the latency for a MIDI device assigned to a MIDI track by recording its audio output back into Pro Tools. Compare the sample locations for the recorded audio events against the original MIDI notes to calculate the latency.

---

## **Stuck Notes**

If you encounter stuck notes with any of your MIDI devices, you can silence them with the All Notes Off command.

### **To turn off all stuck notes:**

- Choose MIDI > All Notes Off.

An All Notes Off message is sent to each channel for all devices in your setup.



# Conductor Tracks and Memory Locations

## Tempo Events

Tempo events can be inserted at the beginning of a session to replace the default tempo (of 120 BPM), and they can be inserted anywhere within the session for additional tempo changes. Tempo events are displayed in the Tempo Ruler.

### To display the Tempo Ruler:

- Select Display > Ruler View Shows > Tempo.

☞ When in Manual Tempo Mode, the Tempo Track is ignored and the session plays at the tempo defined in the Transport window. For details, see “Using Manual Tempo Mode” on page 85.

## Current Tempo

As tempo events are encountered during playback, the session’s current tempo is displayed in the Transport window.

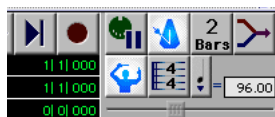

current tempo

Current tempo displayed in Transport window

## Inserting Tempo Events

### To insert a tempo event:

- 1 Click in the Tempo Ruler where you want to insert the tempo event and then choose MIDI > Change Tempo.

– or –

Click in the Tempo Ruler where you want to insert the tempo event and then click the Change Tempo button in the far left of the Tempo Ruler.

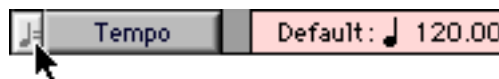

Change Tempo button

– or –

While pressing Control (Macintosh) or the Start key (Windows), move the cursor into the Tempo Ruler (cursor changes to the Grabber with a “+”) and click at the desired location.

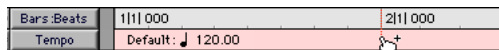

Manually inserting a tempo event

2 In the Tempo Change window, enter the Location and BPM value for the tempo change.

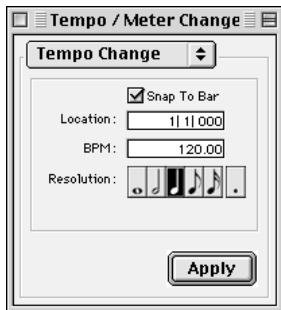

*Tempo Change window*

Select the Snap To Bar option to place the inserted tempo event cleanly on the first beat of the nearest measure.

3 To base the BPM value on something other than the default quarter-note, select a different note value.

4 Click Apply. The new tempo event is inserted and appears in the Tempo Ruler.

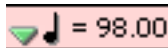

*Inserted tempo event*

Each tempo event has a small green triangle next to it that indicates its location. These triangles can be dragged to move the tempo event, and they can be double-clicked to edit the tempo event.

## Editing and Moving Tempo Events

Existing tempo events can be moved, edited, deleted, and copied and pasted.

### To move a tempo event by dragging:

- In the Tempo Ruler, drag the triangle for the tempo event left or right.

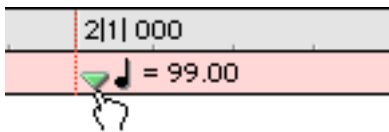

*Dragging a tempo event*

If the Edit mode is set to Grid, the dragged event snaps to the current Grid value. If using Spot mode, the Spot dialog opens.

### To edit a tempo event:

- 1 In the Tempo Ruler, double-click the tempo event.
- 2 In the Change Tempo dialog, enter a new Location or BPM value for the tempo event.
- 3 Click OK.

### To delete a tempo event:

- While pressing Option (Macintosh) or Alt (Windows), move the cursor over the tempo event (cursor changes to the Grabber with a “-”) and click to remove it.

### To copy and paste several tempo events:

- 1 If desired, set the Edit mode to Grid to constrain the selection to the current Grid value.
- 2 Drag in the Tempo Ruler to select the range of measures that includes the tempo events.

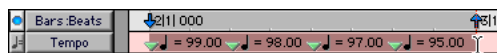

*Tempo events selected*



If the beginning of the selection includes a tempo event, press Command (Macintosh) or Control (Windows) so the Selector appears.

---

\* Press Command+Option (Macintosh) or Alt+Control (Windows) while dragging to select across all Conductor tracks.

---

- 3 Choose Edit > Copy.
- 4 Click in the Tempo Ruler at the point where you want to paste the tempo events.
- 5 Choose Edit > Paste. The contents of the Clipboard are pasted from the insertion point, replacing any existing tempo events.

#### To extend an Edit selection in a track to the Tempo Ruler:

- 1 Using either the Selector or Grabber, select a track range.
- 2 Shift-click in the Tempo Ruler.

Shift-click again in the Tempo Ruler to remove it from the selection.

#### To select all tempo events:

- Double-click with the Selector in the Tempo Ruler.

#### To clear a range of selected tempo events:

- 1 If desired, set the Edit mode to Grid to constrain the selection to the current Grid value.
- 2 Drag in the Tempo Ruler to select the tempo events you want to remove.
- 3 Choose Edit > Clear to delete the selected tempo events.

## Tempo and MIDI and Audio

When editing or moving tempo events, the Bars:Beats Ruler expands or shrinks, as necessary, to accurately reflect the placement of audio regions (which remain constant in terms of sample location). This, in turn, affects the relative placement of MIDI notes, and ensures that the visual relationship between MIDI and audio is accurate.

Figure 17 illustrates how MIDI notes shift and expand in relation to audio after the tempo is reduced.

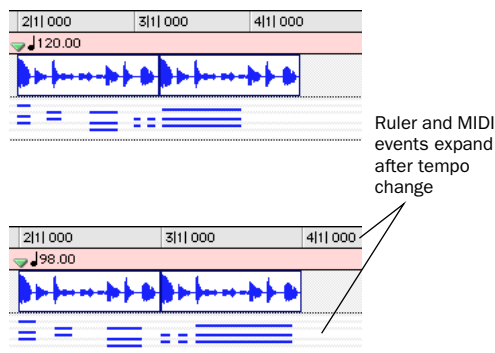

Figure 17. Before and after change in tempo

After editing or moving a tempo event:

- ◆ Bar and beat locations for audio regions (which are sample-based) are adjusted for the new tempo. The audio region's sample and SMPTE locations remain unchanged.
- ◆ MIDI notes (which are tick-based) remain at the same bar and beat location. In relation to audio, however, the notes shrink or expand based on the new tempo, and result in new sample and SMPTE locations for the note start and end times.

---

## Default Tempo

New sessions open with a default tempo of 120 BPM. This tempo can be changed by inserting a tempo event at 1|1|000. However, this is not the same as inserting normal tempo events at other locations. The tempo event that resides at 1|1|000 is actually a Bar|Beat Marker (notice that it has a blue triangle).

The main distinction is that this Bar|Beat Marker can be dragged to any location within the session (such as to align with a particular SMPTE frame) to redefine where 1|1|000 is. This, in effect, moves everything else in the session along with it. Any new bars that precede the default tempo event are numbered as negative.

---

## Identify Beat Command

### Bar|Beat Markers

The Identify Beat command lets you establish a tempo/meter map for audio that was recorded without listening to the click, or for imported audio with unknown tempos.

The Identify Beat command analyzes a selection range (usually with a distinct number of beats or measures) and calculates its tempo based on the specified meter. In doing this, Bar|Beat Markers for the calculated tempo are inserted and appear in the Tempo Ruler at the beginning and end of the selection; in addition, meter events are inserted into the Meter Ruler.

Bar|Beat Markers look similar to tempo events, but instead have small blue triangles to indicate their location.



**Bar|Beat Marker**

The key to accurately defining tempos for a range of audio with the Identify Beat command is to make sure that the initial selection represents an accurate length of beats or measures. In fact, you may want to first loop the selection on playback (see “Looping Playback” on page 171) to see if it plays cleanly without skipping. To avoid drift, select the audio material with the Time Scale set to Samples rather than Bars:Beats.

---

▲ Tempo events and Bar|Beat Markers cannot be mixed. If a session contains tempo events and you attempt to insert Bar|Beat Markers, existing tempo events are converted to Bar|Beat Markers (and vice versa).

---

### To add Bar|Beat Markers for a one-bar drum loop:

- 1 Place a one-bar drum loop at the beginning of an audio track.
- 2 Select Display > Samples. This ensures that the selected audio material will be sample-accurate.
- 3 Select the audio region with the Grabber and choose Edit > Identify Beat.

4 In the Bar|Beat Markers dialog, specify the start and end points for the inserted Bar|Beat Markers. Since this example deals with a one-bar loop, enter 1|1|000 and 2|1|000.

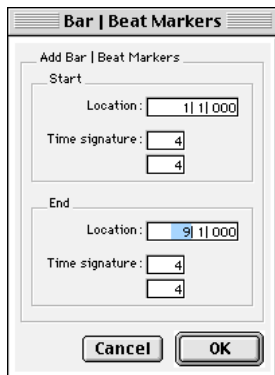

*Identify Beat dialog*

- 5 If necessary, specify a time signature for the start and end range.
- 6 Click OK to automatically calculate the new tempo and insert the necessary Bar|Beat Markers and meter events. Any existing tempo and meter events residing within the selection are deleted.

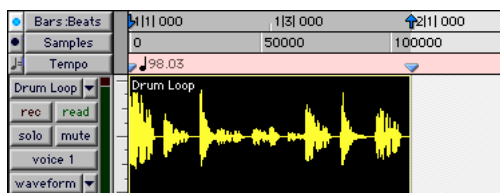

*Bar|Beat Markers inserted*

Once the tempo has been determined for the audio, you can duplicate the original audio region with the Repeat command.

When working with a selection, the Identify Beat command only calculates a single tempo for the selected range. If the tempo varies from measure to measure, or beat to beat, you'll need to use the Identify Beat command for each tempo variance (making sure to accurately define a precise selection range or beat location for the tempo change).

## Inserting Bar|Beat Markers One at a Time

### Audio Material with Varying Tempos

You can insert Bar|Beat Markers one at a time by setting an Edit insertion point (instead of making a selection) before using the Identify Beat command. The ability to identify each beat, one at a time, is especially useful when working with audio with varying tempos.

For instance, if you have a measure that accelerates slightly, you could insert a Bar|Beat Marker on each beat (see Figure 18) so the tempo is accurately reflected.

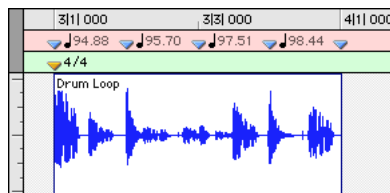
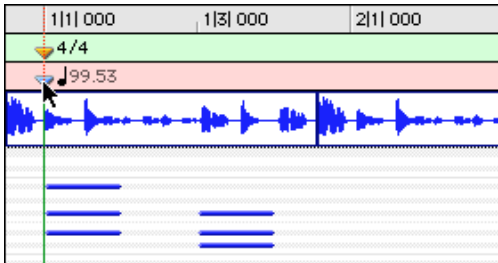

**Figure 18.** Bar|Beat Markers on each beat

After the Bar|Beat Markers are inserted, further adjustments in the tempo map are possible by dragging each of the Markers, as necessary, to align with the associated beat within the audio.

## Dragging Bar|Beat Markers

Bar|Beat Markers can be dragged to new locations so they can align with audio regions that have been moved, or so that they can align to a slightly different point within an audio region. This results in neighboring MIDI data being adjusted to align with the new tempo map.



Dragging a Bar|Beat Marker

## Tempo Events vs. Bar|Beat Markers

Bar|Beat markers and Tempo Events behave differently when you drag them in the Tempo Ruler.

### When dragging a tempo event:

- The tempo event is placed at a new bar and beat location. The sample and SMPTE locations for the event are updated as well.
- The BPM value for the dragged tempo event remains constant, as do any other tempo events in the session.
- Neighboring MIDI events, along with the Ruler, shrink or expand as necessary to adjust for the new tempo location.

### When dragging a Bar|Beat Marker:

- Its BPM value is recalculated along with the Bar|Beat Marker to its immediate left. Bar|Beat Markers to the right of the dragged marker remain unchanged.
- Its bar and beat location is dragged *with* the Bar|Beat Marker. If the Bar|Beat Marker was originally placed at 3|1|000, it remains there (unless it is edited).
- Its sample and SMPTE locations change, as calculated for by the new tempo for the Bar|Beat Marker.
- Neighboring MIDI events, along with the Bars:Beats Ruler, shrink or expand as necessary to adjust for the new tempo.

## Editing Bar|Beat Markers

A Bar|Beat Marker can be edited to redefine its bar and beat location, which also redefines the start or end point of the range being analyzed for tempo. This is different from dragging a Bar|Beat Marker.

### To edit a Bar|Beat Marker:

- 1 In the Tempo Ruler, double-click the Bar|Beat Marker.
- 2 In the Identify Beat dialog, enter a new Location for the Bar|Beat Marker.
- 3 Click OK to recalculate the new tempo.

Like meter and tempo events, Bar|Beat Markers can also be deleted.

### To delete a Bar|Beat Marker:

- While pressing Option (Macintosh) or Alt (Windows), move the cursor over the Bar|Beat Marker (cursor changes to the Grabber with a “-”) and click to remove it.

---

## Meter Events

Meter events can be inserted at the beginning of a session to replace the default meter (of 4/4), and they can be inserted anywhere within the session for additional meter changes. Meter events are displayed in the Meter Ruler.

### To display the Meter Ruler:

- Select Display > Ruler View Shows > Meter.

### Current Meter

As meter events are encountered during playback, the session's current meter is displayed in the Transport window.



current meter

*Current meter displayed in Transport window*

## Inserting Meter Events

### To insert a meter event:

- 1 Choose MIDI > Change Meter.

– or –

Click the Change Meter button in the far left of the Meter Ruler.



*Change Meter button*

– or –

While pressing Control (Macintosh) or the Start key (Windows), move the cursor into the Meter Ruler (cursor changes to the Grabber with a “+”) and click at the desired location.

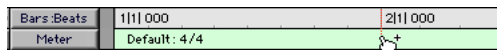

### Manually inserting a meter event

- 2 In the Meter Change window, enter the Location and Meter for the meter change.

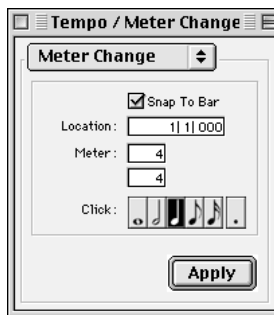

*Meter Change window*

Select the Snap To Bar option if you want the inserted meter event to fall cleanly on the first beat of the nearest measure.

- 3 Select a note value for the number of clicks to sound in each measure. If desired, select the dot (.) option for a dotted click value.

---

\* For some meters, it may be desirable to use a dotted value for the click. For instance, if using a meter of 6/8, a dotted eighth-note click (yielding two clicks per measure) is more suitable than a straight eighth-note click (six clicks per measure).

---

4 Click Apply to insert the new meter event. The new meter event is inserted and appears in the Meter Ruler.



*Inserted meter event*

Each meter event has a small yellow triangle next to it that indicates its location. These triangles can be selected for copying and pasting, and they can be double-clicked to edit the meter event.

### Editing Meter Events

Existing meter events can be edited, deleted, and copied and pasted.

#### To edit a meter event:

- 1 In the Meter Ruler, double-click the meter event.
- 2 In the Change Meter dialog, enter a new Location or Meter for the event.
- 3 Click OK.

#### To delete a meter event:

- While pressing Option (Macintosh) or Alt (Windows), move the cursor over the meter event (cursor changes to the Grabber with a “-”) and click to remove it.

#### To copy and paste several meter events:

- 1 If desired, set the Edit mode to Grid to constrain the selection to the current Grid value.
- 2 Drag in the Meter Ruler to select the range that includes the meter events.

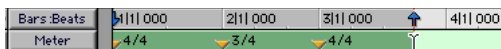

*Meter events selected*

If the beginning of the selection includes a meter event, press Command (Macintosh) or Control (Windows) so the Selector tool appears.

---

\* Press Option+Command (Macintosh) or Alt+Control (Windows) while dragging to select across all Conductor tracks.

---

3 Choose Edit > Copy.

4 Click in the Meter Ruler at the point where you want to paste the meter events.

5 Choose Edit > Paste. The contents of the Clipboard are pasted from the insertion point, replacing any existing meter events.

#### To extend an Edit selection in a track to the Meter Ruler:

- 1 Using either the Selector or Grabber, select a track range.
- 2 Shift-click in the Meter Ruler.

Shift-click again in the Meter Ruler to remove it from the selection.

#### To select all meter events:

- Double-click with the Selector in the Meter Ruler.

#### To clear a range of selected meter events:

- 1 If desired, set the Edit mode to Grid to constrain the selection to the current Grid value.
- 2 Drag in the Meter Ruler to select the meter events you want to remove.
- 3 Choose Edit > Clear to delete the selected meter events.

## Partial Measures

### Aligning Beat 1 to a SMPTE Location

When scoring to film or video, you will often need to start a section of music at a precise SMPTE location. Since this SMPTE location will usually not fall cleanly at the beginning of a measure, you can insert a meter event at the SMPTE location where the music needs to start.

As necessary, Pro Tools will create a partial measure to accommodate the inserted meter event. When a meter event is preceded by a partial measure, the meter event is displayed in italics in the Meter Ruler.

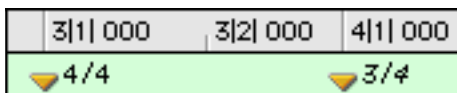

*Partial measure of 4/4*

Partial measures can also occur when pasting meter events to locations other than beat one.

## Memory Locations and Markers

Each session can save up to 200 Memory Locations that can be used to recall:

- Markers to bar and beat locations or SMPTE frames
- Edit selections across one or more tracks
- Record and play ranges, along with pre/post-roll times
- Track settings that include Show/Hide status, Track Heights, and zoom values
- Edit and Mix Groups enables

Memory Locations are viewed and sorted in the Memory Locations window, where they can be recalled by clicking the Memory Location.

---

\* With the Numeric Keypad Mode set to Classic, Memory Locations can be recalled from the numeric keypad by pressing the Memory Location number followed by period.

---

\* With the Numeric Keypad Mode set to Transport or Shuttle, Memory Locations can be recalled from the numeric keypad by pressing period, the Memory Location number, and period again.

---

## Properties of Memory Locations

When creating a new Memory Location (see “Creating Memory Locations” on page 237) you are prompted to define its *Time Properties* and *General Properties*.

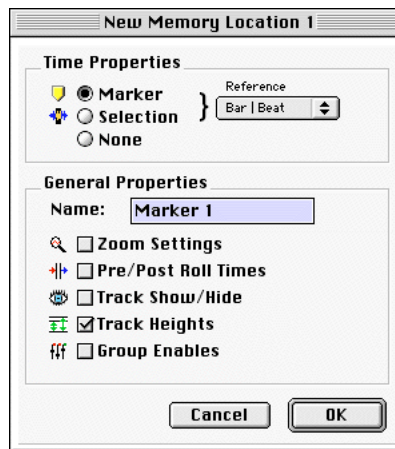

*Memory Location dialog*

## Time Properties

Under Time Properties, a Memory Location can be set to Marker, Selection, or None. This determines the type of Memory Location that is created. Each of these three Memory Location types can also save any combination of General Properties.

**Marker** Recalls a Timeline location whose reference can be either Bar|Beat (tick-based) or Absolute (sample-based). When recalling a *Marker Memory Location*, the playback cursor moves to the Marker's location and the start and end times in the Transport window are also updated. If the Edit and Timeline Selections are linked, the edit cursor also moves to the Marker location.

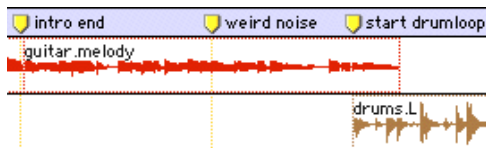

Markers in the Markers Ruler

Markers appear in the Markers Ruler with a thin yellow line extending down through all tracks in the Edit window (to assist in arranging and aligning track material). You can click on a Marker in the Markers Ruler to recall its location along with its stored General Properties.

**Selection** Recalls an edit selection or edit cursor location whose reference can be either Bar|Beat (tick-based) or Absolute (sample-based). A *Selection Memory Location* lets you store edit selections, for one or more tracks, that you return to often within a session. If the Edit and Timeline Selections are linked, a Selection Memory Location can recall record and play ranges.

---

▲ Only contiguous selections can be saved with Memory Locations. Discontiguous selections, made with the Object Grabber, will be recalled as if the selection were made with the Time Grabber.

---

**None** Recalls no Time Properties and is therefore referred to as a *General Properties Memory Location*.

### Bar|Beat and Absolute Reference

The Reference pop-up determines whether the Marker or Selection Memory Location is Bar|Beat or Absolute. When set to Bar|Beat, the Memory Location is tick-based and its bar and beat location remains constant if the tempo is changed—though its relation to audio is scaled, resulting in a new sample location.

When set to Absolute, the Memory Location is sample-based and its bar and beat location shifts if the tempo is changed—though its sample location remains constant, along with its relation to audio material.



Bar|Beat Marker (left) and Absolute Marker (right)

In the Markers Ruler, Markers that are Bar|Beat appear as yellow chevrons, and Markers that are Absolute appear as yellow diamonds.



## General Properties

Any of the three types of Memory Locations (Marker, Selection, and General Properties) can store and recall any combination of the following properties:

**Zoom Settings** Recalls the horizontal and vertical zoom values for both audio and MIDI tracks.

**Pre/Post Roll Times** Recalls pre- and post-roll times (but not whether they are enabled). This property can be stored with a Selection Memory Location to recall record and play ranges along with pre/post-roll.

**Track Show/Hide** Recalls which tracks are hidden. Use this property to display groups of tracks for editing and mixing.

**Track Heights** Recalls all Track Heights. Use this option along with the Zoom Settings option to recall edit environments that are suited for particular tasks, such as editing down to the sample level or trimming MIDI notes.

**Group Enables** Recalls which Edit and Mix Groups are enabled. This option is helpful in recalling groups for particular edit and mixing operations, such as muting all drum tracks or fading a stereo pair.

## Creating Memory Locations

Memory Locations can be created by pressing Enter on the numeric keypad, by Control-clicking (Macintosh) or Start-clicking (Windows) in the Markers Ruler, or by choosing the Add New Memory Location command from the pop-up menu in the Memory Locations window. The method you use will likely depend on the type of Memory Location you want to create.

---

\* When creating Memory Locations, the next available number is assigned to it (1-200). This number is used in recalling the Memory Location from the numeric keypad.

---

### To create a Marker Memory Location:

- 1 Configure any session settings you will save with the Marker Memory Location, such as zoom settings, pre/post-roll times, Show/Hide status for tracks, Track Heights, and Edit and Mix Group enables.
- 2 Make sure to select Operations > Link Edit and Timeline Selection.
- 3 If the Markers Ruler is not displayed, select Display > Ruler View Shows > Markers.
- 4 Click with the Selector at the desired location in any track or Ruler. To place a Marker at the beginning of a region, select the region with the Grabber. Click the Marker Well button to the left of the Markers Ruler (or press Enter on the numeric keypad).



*Marker Well button*

– or –

While pressing Control (Macintosh) or the Start key (Windows), move the cursor into the Markers Ruler (cursor changes to the Grabber with a "+") and click at the desired location.



*Manually inserting a Marker*

**5** In the New Memory Location dialog, select the Marker option and specify the Reference as either Bar|Beat or Absolute.

**6** If desired, enter a name for the new Marker and select any General Properties you want to save with the Marker.

**7** Click OK. The Marker is created and appears in the Markers Ruler, and in the Memory Locations window.

#### **To create a Selection Memory Location:**

**1** Configure any session settings you will save with the Selection Memory Location, such as zoom settings, pre/post-roll times, Show/Hide status for tracks, Track Heights, and Edit and Mix Group enables.

**2** Select a range of material in one or more tracks.

**3** Press Enter on the numeric keypad.  
– or –

From the pop-up menu in the Memory Locations window (click the Name button), choose Add Memory Location.

**4** In the New Memory Location dialog, select the Selection option and specify the Reference as either Bar|Beat or Absolute.

**5** If desired, enter a name for the new Memory Location and select any General Properties you want to save with it.

**6** Click OK. The Selection Memory Location is created and appears in the Memory Locations window.

#### **To create a General Properties Memory Location:**

**1** Configure any session settings you will save with the Selection Memory Location, such as zoom settings, pre/post-roll times, Show/Hide status for tracks, Track Heights, and Edit and Mix Group enables.

**2** Press Enter on the numeric keypad.

**3** In the Memory Location dialog, select the None option.

**4** If desired, enter a name for the new Memory Location and select any General Properties you want to save with it.

**5** Click OK. The Selection Memory Location is created and appears in the Memory Locations window.

---

\* In the New Memory Location dialog, you can Option-click (Macintosh) or Alt-click (Windows) any General Property to enable/disable all properties. You can also Command-click (Macintosh) or Control-click (Windows) any property to toggle its state and the state of all other General Properties.

---

#### **Creating Memory Locations on the Fly**

When the Editing Preference for “Auto-Name Memory Locations When Playing” is enabled, Memory Locations can be created while playing without encountering the New Memory Location dialog. This option can also be selected from the pop-up menu in the Memory Locations window.

This capability is useful if you want to mark certain locations while listening during a record pass, or if you want to mark frame locations while viewing a video scene.

### **To create a Marker during playback:**

- 1** From the pop-up menu in the Memory Locations window, select Default To Marker. This ensures that new Memory Locations default to being Markers.
- 2** From the pop-up menu in the Memory Locations window, select Auto-Name Memory Locations.
- 3** For inserted Markers to have a Bar|Beat reference, make sure to set the Time Scale to Bars:Beats.
- 4** Click Play in the Transport window.
- 5** When the location is reached, press Enter on the numeric keypad. A Marker is automatically created and appears in the Markers Ruler.

When auto-creating Markers, they are named and numbered as “Marker 1,” “Marker 2,” “Marker 3,” etc.

When the option for Default To Marker is deselected, new Memory Locations default to whatever type was last created. Therefore, if a Selection Memory Location was created last, it will be the type that is created on the fly. In this case, the name for the created Memory Location is based on the start of the Edit selection using the time format for the Main Time Scale (such as “2|2|305” or “0:02.658”).

## **Recalling Memory Locations**

Memory Locations can be recalled from the Memory Locations window and from the numeric keypad. In addition, Marker Memory Selections can be recalled by clicking them in the Markers Ruler.

### **To recall a Memory Location:**

- 1** If the Memory Locations window is not already open, choose Windows > Show Memory Locations to display it.
- 2** If recalling a Selection Memory Location that will define a record or play range, make sure to select Operations > Link Edit and Timeline Selection.
- 3** In the Memory Locations window, click the Memory Location to recall it.
  - or –

With the Numeric Keypad Mode set to Classic, press the Memory Location number followed by period.

– or –

With the Numeric Keypad Mode set to Transport or Shuttle, press period, the Memory Location number, and period again.

---

\* When recalling a Memory Location from the numeric keypad, the Memory Locations window does not need to be open.

---

### **To recall a Marker from the Markers Ruler:**

- 1** If the Markers Ruler is not displayed, select Display > Ruler View Shows > Markers.
- 2** Click on the Marker. The playback cursor locates to the Marker and any General Properties stored with the Marker are recalled.

---

\* Even if the Markers Ruler is not displayed, Markers can be recalled from the Memory Locations window, or from the numeric keypad.

---

## Editing Memory Locations

Memory Locations can be renamed, edited, deleted, and copied and pasted.

### To rename a Memory Location:

**1** In the Memory Locations window, double-click the Memory Location you want to rename.

– or –

If renaming a Marker Memory Location, double-click the Marker in the Markers Ruler.

**2** Enter the new name for the Memory Location and click OK.

### To redefine the General Properties stored with a Memory Location:

**1** As desired, make changes to the session's zoom settings, pre/post-roll times, Show/Hide status of tracks, Track Heights, and Group Enables.

**2** In the Memory Locations window, Control-click (Macintosh) or Right-click (Windows) the Memory Location you want to redefine.

– or –

If changing a Marker Memory Location, Control-click (Macintosh) or Right-click (Windows) the Marker in the Markers Ruler.

**3** In the Memory Location dialog, select the General Properties you want to save with the Memory Location.

**4** Enter a new name for the Memory Location, if desired, and click OK.

### To change a Memory Location from one type to another:

**1** In the Memory Locations window, double-click the Memory Location you want to change.

– or –

If changing a Marker Memory Location, double-click the Marker in the Markers Ruler.

**2** In the Memory Location dialog, select either Marker, Selection, or None as the Memory Location type.

**3** Enter a new name for the Memory Location, if desired, and click OK.

### To change the Selection stored with a Memory Location:

**1** If the Memory Locations window is not already open, choose Windows > Show Memory Locations to display it.

**2** Select a range of material in one or more tracks.

**3** In the Memory Locations window, Control-click (Macintosh) or Right-click (Windows) the Memory Location that you want to redefine.

**4** Enter a new name for the Memory Location, if desired, and click OK.

### To move a Marker by dragging:

**1** In the Markers Ruler, drag the Marker left or right.

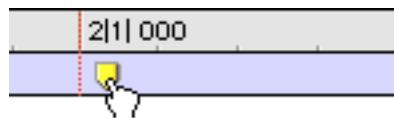

*Dragging a Marker*

If the Edit mode is set to Grid, the dragged event snaps to the current Grid value. If using Spot mode, the Spot dialog opens.

**To align a Marker to a different location:**

- 1 Make sure to select Operations > Link Edit and Timeline Selection.
- 2 In any of the Timebase Rulers, click with the Selector at the new location.
  - or –

Click in the playlist for any track. To align the Marker to the start of a region, select the region with the Grabber.

- 3 In the Memory Locations window or the Markers Ruler, Control-click (Macintosh) or Right-click (Windows) the Marker Memory Location that you want to redefine.
- 4 Enter a new name for the Marker, if desired, and click OK.

## Deleting Memory Locations

**To delete a Memory Location:**

- In the Memory Locations window, select the Memory Location and choose Delete Memory Location from the pop-up menu.
  - or –

In the Memory Locations window, Option-click (Macintosh) or Alt-click (Windows) the Memory Location.

**To delete all Memory Locations:**

- In the Memory Locations Window, choose Delete All from the pop-up menu.
  - or –

Option-Shift-click (Macintosh) or Alt-Shift-click (Windows) any Memory Location in the Memory Locations window.

**To delete a Marker from the Markers Ruler:**

- While pressing Option (Macintosh) or Alt (Windows), move the cursor over the Marker (cursor changes to the Grabber with a “–”) and click to remove it.

## Copying Marker Memory Locations

**To copy and paste a range of Markers:**

- 1 If desired, set the Edit mode to Grid to constrain the selection to the current Grid value.
- 2 Drag in the Tempo Ruler to select the range of measures that includes the Markers.

If the beginning of the selection includes a Marker, press Command (Macintosh) or Control (Windows) so the Selector tool appears.

---

\* Press Command+Option (Macintosh) or Alt+Control (Windows) while dragging to select across all Conductor tracks.

---

- 3 Choose Edit > Copy.
- 4 Click in the Markers Ruler at the point where you want to paste the tempo events.
- 5 Choose Edit > Paste. The contents of the Clipboard are pasted from the insertion point, replacing any existing Markers.

**To extend an Edit selection in a track to the Markers Ruler:**

- 1 Using either the Selector or Grabber, select a track range.
- 2 Shift-click in the Markers Ruler.  
Shift-click again in the Tempo Ruler to remove it from the selection.

### To select all tempo events:

- Double-click with the Selector in the Tempo Ruler.

## Memory Locations Window

Memory Locations are listed, with their name and assigned number, in the Memory Locations window. To recall a Memory Location from this window, simply click it.

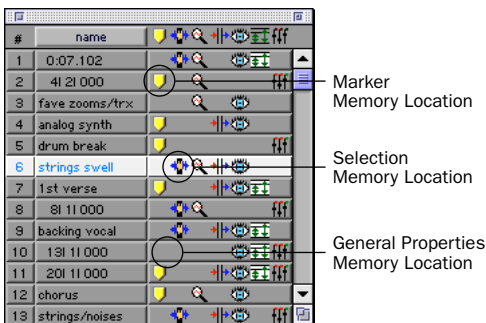

Marker Memory Location  
Selection Memory Location  
General Properties Memory Location

Memory Locations window

You can select viewing and sorting options, along with commands for creating and removing Memory Locations, from the pop-up menu in the Memory Locations window (obtained by clicking the Name button in the upper left).

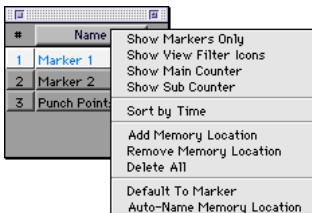

Memory Locations window pop-up menu

The commands and options in this menu are discussed in the following sections.

**Show Markers Only** When selected, only Marker Memory Locations are displayed in the Memory Locations window. However, even when Selection Memory Locations and General Property Memory Locations are hidden, they can still be recalled from the numeric keypad.

**Show View Filter Icons** When selected, the Memory Locations window provides an icon-based “view filter” that allows you to show or hide Memory Locations based on the properties they contain. To show or hide Memory Locations containing a specific property, click the appropriate icon.

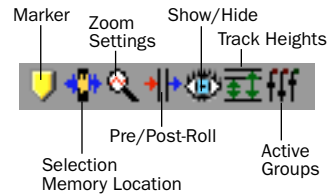

Memory Locations View Filter

If an icon is disabled, all Memory Locations associated with that property are hidden. However, if a Memory Location contains other properties for an icon that is enabled, it is still displayed. When a view icon is enabled, it appears in color. When it is disabled, it appears gray.



Memory Locations window with view filter icons

In addition, the view filter provides a handy reference for which properties are stored in each Memory Location (indicated by a row of icons for each Memory Location).

**Show Main/Sub Counter** When selected, a column appears in the Memory Locations window that displays the locations for Markers, and the start times for Selection Memory Locations. General Property Memory Locations display nothing in this column.

#	Name	Bars:Beats	Time Code
1	Marker 1	3   1 000	00:00:04:00
2	Marker 2	9   1 000	00:00:16:00

*Main/Sub Counters in Memory Locations window*

You can click at the top of these columns for a pop-up menu that will let you change the Main and Sub Time Scale.

**Sort by Time** When selected, Markers are sorted by their order in the Timeline, followed by Selection Memory Locations, which are listed in the order in which they were created.

When Sort by Time is deselected, all Memory Locations are listed in the order of their assigned numbers.

**Add Memory Location** Choose this command to create a new Memory Location.

**Remove Memory Location** Deletes the currently selected Memory Location in the Memory Locations window.

**Delete All** Deletes all Memory Locations (Marker, Selection, and General Property) in the session.

**Default To Marker** When selected, new Memory Locations default to Markers, though in the New Memory Location dialog you can still define the new Memory Location as one of the other types.

**Auto-Name Memory Location** When selected, Memory Locations are created automatically without encountering the New Memory Location dialog. If the Default To Marker option is selected, a Marker Memory Location is auto-created. Otherwise, the Memory Location type is determined by whatever type (Marker, Selection, or None) was created last.





# Advanced Editing

Pro Tools includes a rich advanced editing feature set, which is covered in this chapter.

---

## Using Crossfades

You can quickly and easily crossfade between two adjacent audio regions. Crossfading is the process of fading two regions of audio to prevent pops, clicks, or sudden changes in sound. Crossfades have many applications, from smoothing transitions between regions to creating special audio effects. The crossfade duration, position, and shape are all user-definable.

Crossfades are computed and written to disk. Crossfades that are written to disk are stored in a folder named “Fade Files” within the session folder. When you play back your track, Pro Tools reads and plays back the crossfade file from disk.

---

\* Pro Tools 24 and MIX systems also include an Auto Fade feature that provides real-time fades without processing them to disk. See “Using the AutoFade Feature” on page 254.

---

## About Crossfades and Curves

To create a crossfade between two regions, the regions must be contiguous. Use the Selector to select across the point where the regions touch. The length of the selection determines the length of the crossfade. Though fades may appear to be discrete regions, they cannot actually be separated from the regions in which they were created. You can, however, create fade-ins and fade-outs for individual regions (see “Creating Fades at the Beginnings and Ends of Regions” on page 253).

You can use the Fades dialog to select, view, and manipulate the curves used to perform the crossfade. Different volume curves can be assigned to the fade-out and fade-in portions of crossfades. The Fades dialog can also render a preview of the fade.

The following examples illustrate common crossfade types, and explain how the type of selection you make determines the character of the crossfade.

---

▲ Since crossfades are created by fading between overlapping audio material, a crossfade cannot be performed on regions that do not contain audio material beyond their region boundaries.

---

## Standard Crossfade (“Centered”)

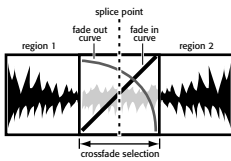

*‘Centered’ crossfade*

This type of selection creates a crossfade on both sides of the splice point, which affects the volume of region 1 and region 2. It is the most common type of crossfade.

This crossfade type requires that region 1 contain audio material beyond its end point, and region 2 contain audio material before its start point.

## Pre Crossfade

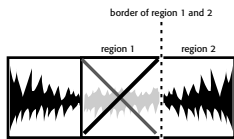

*‘Pre’ crossfade*

This type of selection creates a crossfade before the splice point. This lets you maintain the volume of the very beginning of region 2 instead of fading across it, which is useful if there is a strong attack at the beginning of region 2 that you want to preserve. When making selections for crossfades that occur on the border of two regions, you can use the Tab key to move the cursor to the exact beginning or end of a region.

This crossfade type requires that region 2 contain audio material before its start point.

## Post Crossfade

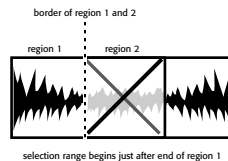

*‘Post’ crossfade*

This type of selection creates a crossfade after the splice point. It is useful if you want to maintain the amplitude of region 1 until its very end. When making selections for crossfades that occur on the border of two regions, you can use the Tab key to move the cursor to the exact beginning or end of a region.

This crossfade type requires that region 1 contain audio material beyond its end point.

## The Fades Dialog

When choosing the Fades command you can use the Fades dialog to select, view, and preview the crossfade, and to edit the curves used to perform the crossfade.

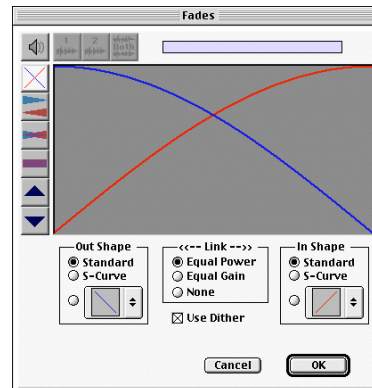

*Fades dialog*

The controls in the Fades dialog include:

### **Audition**



Click this button to audition your crossfade. Pro Tools plays the audio in one of two ways, depending on your system:

- Pro Tools 24 MIX and Pro Tools 24 systems allow crossfade auditioning directly from your audio interface outputs.
- All other Pro Tools systems use Apple's Sound Manager to audition crossfades. Use the Digidesign Sound Drivers (automatically installed with Pro Tools) to audition via your audio interface outputs. Use the Macintosh Sound Control Panel to set the Output choice to Digidesign Sound Drivers. (If you do not use the Sound Drivers, you will hear crossfades through the Macintosh's audio output.)

### **View First Track**



If you are fading between more than one track, this button allows you to view and preview the audio of the first pair of adjacent tracks.

### **View Second Track**



If you are fading between more than one track this button allows you to view and preview the audio of the second pair of adjacent tracks.

### **View Both Tracks**



Click this button to display the waveforms of the first two adjacent tracks in a multi-track fade.

### **Fade Curves Only**



Click this button to display the specified fade curves without showing the actual audio waveforms. This is the default view when you open the Fades dialog.

### **Fade Curves and Separate Waveforms**



Click this button to display the specified fade curves along with separate views of the fade-in and fade-out waveforms.

### **Fade Curves and Superimposed Waveforms**



Click this button to display the specified fade curves along with superimposed views of the fade-in and fade-out waveforms.

### **Fade Curves and Summed Waveform**



Click this button to display the specified fade curves along with a single waveform representing the summation of the crossfaded audio.

### **Zoom In**



Click this button to scale the view of the waveform's amplitude upwards. Command-click (Macintosh) or Control-click (Windows) for the default view scale.

## Zoom Out



Click this button to scale the view of the waveform's amplitude downwards. Command-click (Macintosh) or Control-click (Windows) for the default view scale.

## Fade Out Shape Parameter

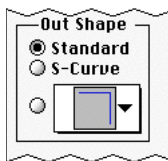

### Fade Out Shape

The Out Shape parameter allows you to choose the shape of the fade-out from region 1.

**Standard** Selects a single continuous fade curve. This creates a general-purpose fade that can be edited by dragging the curve itself.

**S-Curve** Selects an S-shaped curve, which inverts its beginning and end characteristics. This makes it possible to fade in faster at the curve's start and slower at its end, for example. S-shaped curves can be useful with material that is difficult to crossfade effectively. S-curves can be edited by dragging the curve in the curve editor.

**Preset Curves** Seven commonly used preset curves are provided for fast crossfade creation. These can be edited by dragging the end points of the curve in the curve editor portion of this dialog. The seven presets are as follows:

◆ Preset Curve 1 keeps region 1 at full volume throughout the crossfade, then immediately drops the volume at the end of the crossfade.



*Preset Curve 1*

◆ Preset Curve 2 fades out region 1 relatively slowly, keeping the volume fairly high throughout the duration of the fade.



*Preset Curve 2*

◆ Preset Curve 3 fades out region 1 slightly faster, keeping the volume slightly lower during the fade.



*Preset Curve 3*

◆ Preset Curve 4 fades out region 1 with a linear fade. This is the default curve.



*Preset Curve 4*

◆ Preset Curve 5 fades out region 1 quickly at the beginning of the crossfade.



*Preset Curve 5*

◆ Preset Curve 6 drops the volume of region 1 even more quickly at the beginning of the crossfade.



*Preset Curve 6*

- ◆ Preset Curve 7 silences region 1 at the beginning of the crossfade.



Preset Curve 7

## Link Parameters

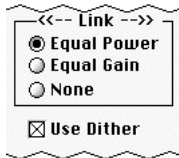

### Fade Link

The Link parameter links the selected fade-out and fade-in curves. If you adjust one curve, the corresponding curve also adjusts. This ensures that the resulting crossfade is an *equal power* or *equal gain* crossfade, depending on which you select.

**Equal Power** Recommended for material that is not phase coherent, as in the case of a crossfade between two completely different types of material. Use this option to avoid the volume drop that can occur with an Equal Gain crossfade. With this fade, you can Option-click (Macintosh) or Alt-click (Windows) the fade curve to reset it to its default shape.

**Equal Gain** Recommended for material that is phase-coherent or nearly phase-coherent, as in the case of a crossfade between identical regions/instruments (a repeated drum loop, for example). Use this option to avoid clipping that can occur when using an Equal Power crossfade. With this fade, you can Option-click (Macintosh) or Alt-click (Windows) the fade curve to reset it to its default shape.

**None** Disables linking between the fade-out and fade-in curves, and lets you freely adjust them separately, including start and end points. This option also allows you to create custom crossfade shapes. To edit only the fade-in portion of the curve, press Option (Macintosh) or Alt (Windows) while dragging. To edit only the fade-out portion of the curve, press Command (Macintosh) or Control (Windows) while dragging.

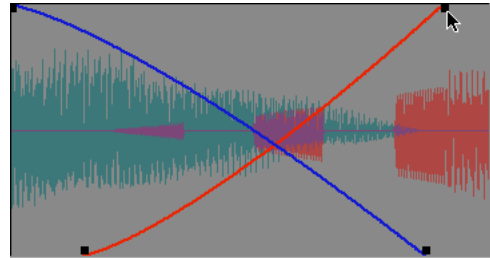

Adjusting the end point of a fade curve

## Use Dither

Use Dither

### Dither option for Fade

The Use Dither option turns on the noise-shaped Dither function, which improves audio performance when mixing or fading low-level audio signals. Use this option for fading in or fading out silence, and crossfading between low amplitude regions. Dithering is usually not necessary when fading between two regions of high amplitude. You can disable Dither while editing your crossfade in the Fades dialog to speed up previews and fade recalculation, then re-enable Dither to create the final crossfade.

## Fade In Shape Parameters

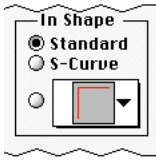

### Fade In Shape

The In Shape parameter allows you to choose the shape of the fade-in to region 2.

**Standard** Selects a single continuous fade curve. This creates a general-purpose fade that can be edited by dragging the curve itself.

**S-Curve** Selects an S-shaped curve, which inverts its beginning and end characteristics. This makes it possible to fade in faster at the start of the curve, and slower at the end. S-shaped curves are useful with material that is difficult to crossfade effectively. S-curves can be edited by dragging the curve in the curve editor.

**Preset Curves** Seven commonly used preset curves are provided for fast crossfade creation. These can be edited by dragging the end points of the curve in the curve editor portion of this dialog. The seven presets are as follows:

- ◆ Preset Curve 1 fades in region 2 at full volume immediately at the beginning of the crossfade and keeps it there throughout the crossfade.



Preset Curve 1

- ◆ Preset Curve 2 fades in region 2 quickly in the beginning, reaching full amplitude fairly early in the crossfade.



Preset Curve 2

- ◆ Preset Curve 3 fades in region 2 moderately fast.



Preset Curve 3

- ◆ Preset Curve 4 fades in region 2 with a linear fade curve. This is the default curve.



Preset Curve 4

- ◆ Preset Curve 5 fades in region 2 slowly at the beginning of the crossfade.



Preset Curve 5

- ◆ Preset Curve 6 fades in region 2 even more slowly than the previous curve.



Preset Curve 6

- ◆ Preset Curve 7 silences region 2 until the end of the crossfade.



Preset Curve 7

## Typical Curve Combinations

Following are the available combinations of fade-out and fade-in curves.

**Linear Crossfade** This is a good general purpose crossfade with a smooth, even transition between region 1 and region 2.

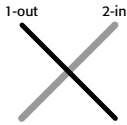

*Linear Crossfade*

**Equal Power Crossfade** This is a good general purpose crossfade useful in cases where a linear crossfade seems to create a noticeable drop in volume across the splice point.

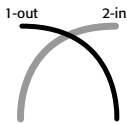

*Equal Power Crossfade*

**Overlap Fade** This combination of curves keeps both regions at full amplitude throughout the crossfade: region 2 “jumps in” at the beginning and region 1 “jumps out” at the end.

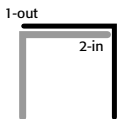

*Overlap Crossfade*

## Fade and Crossfade Preferences

### (TDM Systems Only)

You can set default fade and crossfade settings. These settings load as your “base” settings when you use the Create Fades command, and the Fade to Start and Fade to End commands.

### To set the crossfade preferences:

- 1 Choose Setups > Preferences and click Editing.
- 2 Set the Pre-Roll and Post-Roll times for Fade previews.

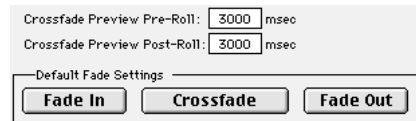

### Fade and Crossfade Preferences

- 3 Click Fade In and set the default shape for fade-ins, then click OK.
- 4 Click Fade Out and set the default shape for fade-outs, then click OK.
- 5 Click Crossfade and set the default shape for crossfades, then click OK.
- 6 Click Done.

## Creating a Crossfade

### To create a crossfade between two regions:

- 1 With the Selector, click at the point where you want the crossfade to begin in the first region and drag to where you want it to end in the second region.

Two regions must touch or overlap in order for Pro Tools to generate a crossfade (fade-ins and fade-outs do not require this, as

they occur inside a single region). Crossfade selections can begin and end anywhere in their respective regions.

- 2 Choose Edit > Fades > Create Fades.
- 3 Use the view buttons to adjust the view of the crossfade. It may take a few moments to calculate the waveform display for long selections.
- 4 Select an Out Shape and an In Shape.
- 5 Choose a Linking option.
- 6 Click the Audition button, or play the session, to hear the crossfade. For long crossfades, it may take Pro Tools a few moments to calculate and load the audio into playback RAM.
- 7 Adjust the curves by choosing different preset shapes with the Out Shape and In Shape pop-up menus.

– or –

Drag the Fade In/Out curves to the desired shape. By choosing None as the Linking option, you can drag the beginning or end points of a fade curve to adjust its beginning or end point.

- 8 Click the Audition button, or play the session, to hear the crossfade again.
- 9 When the crossfade is right, click OK. The fade is calculated and written to disk, but the audio files and regions remain unchanged. Crossfades are stored in the Fades Folder within the session folder.

After you have created a crossfade, it is still possible to edit its length by selecting the crossfade region with the Trimmer and dragging the start or end points.

#### **To remove a crossfade:**

- Select the area of the track containing the crossfades you want to delete and choose Edit > Fades > Delete Fades.

– or –

Select the crossfade with the Grabber and press Delete (Macintosh) or Backspace (Windows).

#### **To trim a crossfade:**

- 1 Select the crossfade with the Grabber, or double-click it with the Selector.
- 2 With the Trimmer, trim either side of the crossfade. The crossfade is recalculated to reflect the newly trimmed length.

#### **Pre/Post Crossfade Selections**

By making a selection that begins or ends precisely on the border of two regions, you can create “pre” or “post” crossfades. Use the Tab key to place the insertion point at the exact beginning or end of a region.

#### **To create a pre- or post-crossfade:**

- 1 With the Selector, click in the track that contains the regions you want to crossfade.
- 2 Press Tab to move forward to the next region boundary. Press Option+Tab (Macintosh) or Control+Tab (Windows) to move back to the previous region boundary.
- 3 Shift-drag to adjust your selection, or press Shift+Tab to extend the selection forward to the next region boundary. Press Option+Shift+Tab (Macintosh) or Control+Shift+Tab (Windows) to extend the selection back to the previous region boundary.
- 4 Choose Edit > Fades > Create Fades.
- 5 Choose a fade type and click OK.



---

## Creating Fades at the Beginnings and Ends of Regions

In addition to crossfades between regions, Pro Tools lets you create fade-ins and fade-outs at the beginnings and ends of regions. On Pro Tools 24 MIX and Pro Tools 24 systems, you can also use an automatic fade-in/out option, which applies *real time* fade-ins/outs to all regions during playback. These fades are not written to disk, but automatically applied during playback.

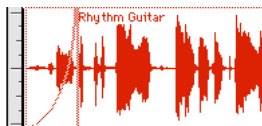

Region with a fade-in

### Creating Fade-Ins/Outs

Depending on how you make the selection, you can position a fade-in/out at the exact beginning or end of a region, or position it so it extends into a blank area of the track. The length of the selection in the region determines the length of the fade-in/out.

You can also fade to the beginning or end of a region from an insertion point.

#### To create a fade-in:

**1** Select the beginning of the region that you want to fade in. The selection must extend to the exact beginning of the region or a blank area prior to the region in the track.

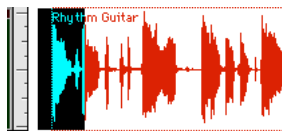

Selecting the beginning of a region for a fade-in

**2** Choose Edit > Fades > Create Fades. Choose your fade-in curve and other parameters.

**3** Click the Audition button to hear the fade (or press the Spacebar to start/stop playback).

**4** You can adjust the curve by dragging it or by choosing a different shape with the In Shape pop-up menu.

**5** When you are finished, click OK.

Pro Tools calculates the fade and writes it to disk. The chosen fade curve appears in the region.

#### To create a fade-out:

**1** Select the end of the region that you want to fade out. The selection must extend to the exact end of the region or a blank area after the region in the track.

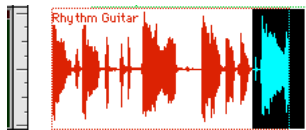

Selecting the end of a region for a fade-out

**2** Choose Edit > Fades > Create Fades.

Choose your fade-out curve and other parameters.

**3** Click the Audition button to hear the fade (or press the Spacebar to start/stop playback).

**4** You can adjust the curve by dragging it or by choosing a different shape with the Out Shape pop-up menu.

**5** When you are finished, click OK. Pro Tools calculates the fade and writes it to disk. The chosen fade curve appears in the region.

---

\* After you have used the Fades command to create a fade-in/out, you can still edit the length of the fade by resizing its length with the Trimmer.

---

**To fade from the insertion point to a region start point:**

**1** Place the cursor at the desired location in the region.

**2** Choose Edit > Fades > Fade To Start.

**3** The fade is applied based on the Fade In Preferences.

**To fade from the insertion point to a region end point:**

**1** Place the cursor at the desired location in the region.

**2** Choose Edit > Fades > Fade To End.

**3** The fade is applied based on the Fade Out Preferences.

## Using the AutoFade Feature

### {Pro Tools 24 MIX and Pro Tools 24 Only}

On Pro Tools 24 MIX and Pro Tools 24 systems, you can choose to have Pro Tools automatically apply real-time fade-ins/outs to all region boundaries in the session. These fade-ins/outs are performed during playback and do not appear in the Edit window, and are not written to disk.

This automatic fade-in /out option also has an effect on virtual track switching in a session. Whenever a lower-priority virtual track “pops thru” a silence in a higher-priority track on the same voice, a fade-in and fade-out is applied to the transition.

This feature is especially useful in post-production situations such as dialogue tracking. For example, you could assign both a dialogue track and a “room tone” track with matching background to the same voice. You could then set the Auto-Fade option to a moderate length (4 ms or so) so that whenever a silence occurred in the dialog, playback would switch smoothly to and from the background track without clicks or pops.

Using automatic fade-ins/fade-outs saves you the trouble of editing to zero-crossings or creating numerous rendered fades in order to eliminate clicks or pops in playback. However, since these autofades are not written to disk, those clicks or pops still exist in the underlying sound file. Consequently, those anomalies still appear if the Duplicate AudioSuite Plug-In or the Export Selected as Sound Files command (from the Audio Regions List) are used to duplicate

multiple regions as a continuous file. To render these real-time auto fades to disk, choose File > Bounce to Disk.

### To set the length of automatic fade ins/outs:

- 1 Choose Setups > Preferences and click Operation.
- 2 Enter a value between 0 and 10 ms for the Auto Region Fade In/Out Length. A value of zero means that no auto-fading will occur.
- 3 Click Done. The Auto Fade value is saved with the session, and is automatically applied to all free-standing region boundaries until you change it.

\* The default value for this setting is zero.

## Creating Fades and Crossfades in Batches

In “Batch Mode” you can create many fades at once. You select across several regions and use the Create Fades command to create crossfades for each region transition. If your selection includes regions that already have crossfades, this feature allows you to modify them.

### To create crossfades between multiple regions at once:

- 1 With the Selector, click in the first region in which you want to create a crossfade. Make sure that the selection includes the entire region.

- 2 Drag to extend the selection to the last region you want to crossfade. Make sure that the selection includes the entire region.

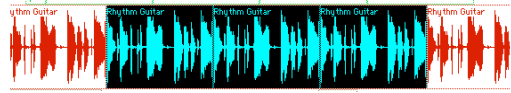

Selected regions for batch fades

- 3 Choose Edit > Fades > Create Fades.
- 4 Select whether you want to Create New Fades, Create New Fade-Ins and Outs, Adjust existing Fades, or a combination of these options.

If you select to create new fades and new fade-ins and outs, new crossfades are created at each region boundary that is bordered by another selected region, a fade-in is created at the start of the first region, and a fade-out is created at the end of the last region.

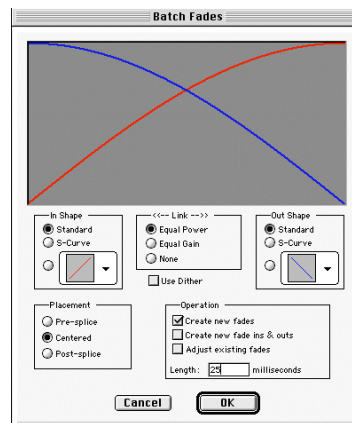

Batch Fades dialog

- 5 Choose the placement of your Fades. You can choose Pre-Splice, Centered, or Post-Splice.
- 6 Enter a crossfade length in milliseconds.

7 Click OK. Pro Tools creates the fades for the selected regions.

\* You can edit the length of a fade after you create it by resizing it with the Trimmer.

## Stripping Silence From Regions

The Strip Silence command examines a selection and removes any areas of silence (sections where the amplitude level falls below a pre-defined level for a user-selectable period of time). The Strip Silence command does this by dividing the selected region into smaller regions and removing the silent regions.

You can use this feature to automatically divide a track into regions, which can be useful if you want to quantize your audio to musical values or SMPTE locations. It can also be useful if you want to get rid of silent areas to prepare for compacting audio (see “Compacting an Audio File” on page 199).

## What Happens to Stripped Audio?

New regions, with the exception of the “stripped out” silent regions, appear in the Audio Regions List. The Strip Silence command is nondestructive and does not actually remove any audio data from the parent audio file. You can use the Heal Separation command to mend stripped regions.

## Identifying Silence

You can identify the audio signal that qualifies as “silence” by making a selection of silence in a track and using the Identify Silence command. The amplitude of the selection is analyzed and stored as a setting that is recalled whenever you use the Strip Silence command in the session.

## Strip Silence Setting

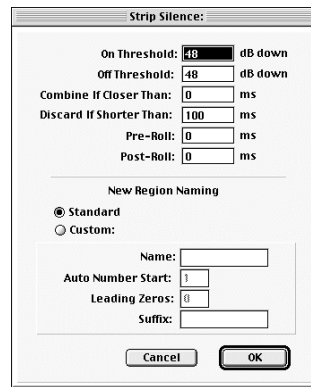

*Strip Silence dialog*

The Strip Silence dialog has six parameters:

**On Threshold** Audio above this dB level remains in the selection and is not stripped out.

**Off Threshold** Audio that falls below this dB level is stripped out.

**Combine If Closer Than** If the end of one region and the start of the next region are closer than this time value, they are combined into the same region.

**Discard If Shorter Than** If a region’s length is shorter than this time value it is discarded.

**Pre-Roll** Specifies a time value to add to the start of regions created with the Strip Silence command. For example, a value of 200 ms of Pre-Roll will add 200 ms to the beginning of each stripped region. Different values here can be useful for preserving certain types of data, such as breaths on vocal tracks that would otherwise be stripped out, resulting in an unnatural, “gated” sound.

**Post-Roll** The value that you enter here is appended to the end of regions created with the Strip Silence command.

## Region Naming

The Strip Silence dialog also contains parameters for how resulting regions are named. You can choose to use standard naming conventions, or define your own. The Custom naming option has four parameters:

**Name** Specifies the base name for regions created with the Strip Silence command.

**Auto Number Start** Specifies the number at which sequential auto-numbering starts.

**Leading Zeros** Specifies the number of zeroes that occur before the appended auto numbers.

**Suffix** Specifies any text appended to the end of the name, following the auto numbering.

For example, if you set the naming parameters to:

- Name = SFX
- Auto Number Start = 23
- Leading Zeros = 1
- Suffix = .Reel1

The names generated for regions created by the Strip Silence command would be:

- SFX023.Reel1
- SFX024.Reel1
- SFX025.Reel1
- SFX026.Reel1
- SFX027.Reel1
- SFX028.Reel1

### To identify silence:

- 1 Select a portion of silence in a track.
- 2 Choose Edit > Identify Silence. A dialog appears displaying the silence’s dB parameters. If these are satisfactory, click OK.

### To strip silence from a selection:

- 1 Select one or more audio regions.
- 2 Choose Edit > Strip Silence.
- 3 Enter the desired parameters to define the silence. If you had previously identified silence, these parameters are filled in with the pre-calculated values.
- 4 Choose a naming scheme. If you choose Custom, enter the desired parameters.
- 5 Click OK. Pro Tools divides the selection into regions, stripping out any areas that meet your specifications for silence.

---

## Inserting Silence

The Insert Silence command is a simple and convenient way to insert silence in sessions. This command allows you to make a selection on a track (or tracks) and insert precisely that amount of silence. In Shuffle Mode, all data on the track is shuffled later in the track by an amount equal to the selection.

In Grid Mode, the Insert Silence command works just like the Clear command.

**Shuffle Mode** When inserting silence on multiple tracks in Shuffle mode, the following conditions apply:

- ◆ If any track is displayed as audio/MIDI data, the selected duration of silence is inserted into the audio/MIDI data and all underlying automation data on all selected tracks. All subsequent regions are shuffled by the amount of silence inserted. On MIDI tracks, only notes that are selected from the beginning are affected, so if you have selected the tail of a note and you Insert Silence, the note will remain unchanged.
- ◆ If all selected tracks are displayed as automation data, the selected range is cleared of automation data only of the type visible on each track. Regions are *not* shuffled. Instead, a blank gap appears equal to the length of the selection.
- ◆ If all selected tracks are displayed as automation data, press Control (Macintosh) or the Start key (Windows) while choosing the Insert Silence command to insert silence on all automation playlists for all selected tracks. Regions are *not* shuffled.

**Slip Mode** When inserting silence on multiple tracks in Slip mode, the following conditions apply:

- ◆ If any track is displayed as audio/MIDI data, the selected range is cleared of audio/MIDI data and all underlying automation data on all selected tracks.
- ◆ If all selected tracks are displayed as automation data, silence is inserted only into the automation type visible on each track.
- ◆ If all selected tracks are displayed as automation data, press Control (Macintosh) or the Start key (Windows) while choosing the Insert Silence command to insert silence on all automation playlists for all selected tracks.

### To insert silence into a track:

- 1 Make a selection on the desired tracks. The length of the selection determines the duration of the silence inserted.
- 2 Choose Edit > Insert Silence.

Pro Tools inserts the selected amount of silence. In the process, it splits the regions at the beginning of the insertion point, and moves the new regions later in the track by an amount equal to the length of the selection.

---

## The Time Trimmer

### (TDM Systems Only)

The Time Trimmer is a convenient tool for matching an audio region to the length of another region, a tempo grid, a video scene, or to practically any other reference point you want.



*Time Trimmer over a region*

The Time Trimmer works by using the Time Compression/Expansion AudioSuite Plug-In to create a new audio file. You use the Time Trimmer by dragging the region's start or end point to expand or compress the region.

### **Time Compression/Expansion Plug-In Preferences**

You can select settings for the Time Compression/Expansion AudioSuite Plug-In by choosing from the pop-up list in the Processing Preferences, under "Default TC/E Settings." The settings available are presets included with Pro Tools; in addition, if you save your own presets for the Time Compression/Expansion Plug-In, they also appear.

---

☞ Refer to the *DigiRack Plug-Ins Guide* for more information about AudioSuite Plug-Ins.

---

### **Using the Time Trimmer in Grid Mode**

The Time Trimmer can be used in Grid Mode to match a region to the tempo of a session or a section of a session. For example, you might import a one-bar drum loop with a tempo of 90 BPM into a session with a tempo of 120 BPM. In Grid Mode, you can use the Time Trimmer to simply and quickly "compress" the drum loop to the length of one measure, with minimal loss of audio fidelity.

### **To use the Time Trimmer in Grid Mode:**

- 1 Set the Edit mode to Grid.
- 2 Select "TCE Trimmer" from the Trimmer pop-up menu.



*Trimmer set to TCE*

- 3 With the Time Trimmer, drag the region's start or end point to compress or expand the region to the grid (for example, by quarter notes). The region is automatically processed using the Time Compression/Expansion AudioSuite Plug-In. The new region appears in the playlist and in the Regions List.

### **Using the Time Trimmer in Slip Mode**

#### **To use the Time Trimmer in Slip Mode:**

- 1 Set the Edit mode to Slip.
- 2 Select "TCE Trimmer" from the Trimmer pop-up menu.
- 3 With the Time Trimmer, drag the region's start or end point to compress or expand the region freely. A new region is automatically processed using the Time Compression/Expansion AudioSuite Plug-In. The new region appears in the playlist and in the Regions List.

### **Using the Time Trimmer in Spot Mode**

In Spot Mode, clicking with the Time trimmer in a region opens the Spot Dialog. You can specify the location you want the region to start or end at, or the duration of the region, and the region is automatically compressed or expanded as specified.

### **To use the Time Trimmer in Spot Mode:**

- 1** Set the Edit mode to Spot.
- 2** Select “TCE Trimmer” from the Trimmer pop-up menu.
- 3** Click on the region, near its start or end point. The Spot Dialog opens. Using any Time Scale, enter a new start or end time (or duration) for the region, then click OK. A new region is automatically processed using the Time Compression/Expansion AudioSuite Plug-In. The new region appears in the playlist and in the Regions List.

---

## **Compress/Expand Edit To Play**

### **(TDM Systems Only)**

When the Edit and Timeline selections are unlinked, you can compress or expand an audio selection to fit the Timeline selection. This feature works by using the Time Compression/Expansion Plug-In to expand or compress the selected audio material.

### **To fit an Edit selection to the Timeline:**

- 1** Deselect Operations > Link Edit and Timeline Selection.
- 2** With the Selector, select the audio material to be compressed or expanded.
- 3** In any Timebase Ruler, select the time range where you want to fit the audio material.
- 4** Choose Edit > Compress/Expand Edit To Play. The Edit selection is compressed or expanded to the length of the Timeline selection.

## **Fitting an Audio Region to an Edit Selection**

Regions can be dragged from the Audio Regions List to fit within an Edit selection. The dragged region is compressed or expanded to fit within the selection. This feature uses the Time Compression/Expansion Plug-In to expand or compress the audio region.

### **To fit an audio region to an Edit selection:**

- 1** With the Selector, select the desired time range in an audio track.
- 2** Command-Option-drag (Macintosh) or Control-Alt-drag (Windows) the region from the Audio Regions List to the track with the selection. The start of the region is positioned at the selection start, and the region is compressed or expanded to match the length of the selection.

---

## **Repeat Paste To Fill Selection**

### **(TDM Systems Only)**

The Repeat Paste To Fill Selection command allows you to automatically fill a selection with audio or MIDI data without requiring you to duplicate the regions manually. To use Repeat Paste, copy an audio or MIDI region, then make a selection and use the command to fill the selection. When pasting audio regions, you are prompted to specify a crossfade to be used for the pasted regions.

If you fill an area that is an exact multiple of the copied region size (for example, filling 16 bars with a 4-bar loop), the copied



selection is pasted in exactly as many times as it takes to fill the selection. If you fill an area that is not an exact multiple of the copied region size (for example, filling 15 seconds of a track with a 2 second atmosphere or room noise region), the remaining selection area is filled with an automatically trimmed version of the original selection.

### To fill a selection with Fill Paste:

- 1 Select the audio or MIDI region you want to copy and choose Edit > Copy.

- 2 Select the area you want to fill using the Selector and choose Edit > Repeat Paste To Fill Selection.

- 3 If pasting audio regions, the Batch Fades dialog opens. Configure the dialog as desired to insert crossfades between each pasted region, then click OK.

– or –

If you do not want crossfades for the pasted audio, click Cancel in the Batch Fades dialog.

---

## Replacing Regions

### (TDM Systems Only)

You can use the Replace Region function to replace multiple instances of a region in a playlist with another region that you Command-drag (Macintosh) or Control-drag (Windows) from the Regions List.

This is useful in post-production if you use a sound effect, room noise, or atmosphere region many times in a session, and later decide to replace one or all of the original regions with a different region.

This is also useful in music production if you want to replace a certain loop or sample (for example, a drum beat) with a new one. You can use this compositionally, if you know the tempo of a section or session, to create a scratch piece with “rough” regions of the correct length, and later replace them with “final” regions of the same length.

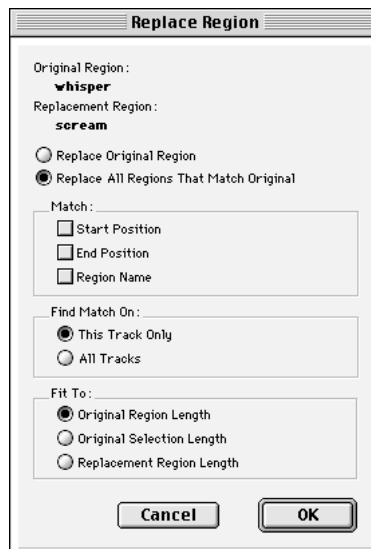

*Replace Region dialog*

The following options are available in the Replace Region dialog:

**Replace Original Region** Replaces only the selected region with the replacement region dragged from the Regions List.

**Replace All Regions That Match Original** Replaces all regions that fit the Match criteria and the Find Match On criteria with the replacement region from the Regions List.

**Match: Start Position** Replaces all regions that have the same original *start* time as the selected region. This includes regions that may have been auto-created when trimming end points.

**Match: End Position** Replaces all regions that have the same original *end* time as the selected region. This includes regions that may have been auto-created when trimming start points.

**Match: Region Name** Replaces all regions that have the same name as the selected region.

---

\* Region matching uses all specified Match criteria. For example, if you select Start Position and End Position, all regions from the same original audio file as your selection with the same original start and end times will be replaced.

---

**Find Match On: Target Track** Replaces regions that fit the Match criteria and are on the same track as the original region.

**Find Match On: All Tracks** Replaces regions that fit the Match criteria for all tracks in the session.

**Fit to: Original Region Length** If the replacement region is smaller than the original region, the region is placed in the playlist and any remaining audio from the original region is removed.

If the replacement region is larger than the selection, it is placed in the playlist and trimmed to fit within the length of the original region.

**Fit to: Original Selection Length** When the playlist selection extends beyond the original region, the replacement region (if larger than the original region) is trimmed to fit within the selection.

**Fit to: Replacement Region Length** The replacement region is placed in its entirety, regardless of the length of the original region or selection.

---

▲ The Replace Region function only works on a selection that includes a single region on one track. The function is not available when the playlist selection includes the start points for two or more regions. Also, if the selection is across several tracks, only the selection in the first (top) track is used.

---

#### **To replace regions:**

- 1** Select a region in a track's playlist that you want to replace. If desired, the selection can extend beyond the region's end point, to include material from the replacement region that is longer than the original region.
- 2** Command-drag (Macintosh) or Control-drag (Windows) the replacement region from the Regions List to the selected region. The Replace Region dialog opens.
- 3** If you only want to replace only the original region, select Replace Original Region.  
– or –

If you want to replace multiple regions, select Replace All Regions That Match Original, and set the Match criteria.

- 4** Select whether to apply the replacement to all tracks, or only to the track with the current selection.

5 Select whether to fit the replacement regions to the current selection, the entire region, or the entire replacement region regardless of the destination length.

6 When you have set all the options, click OK.

---

## Processing Audio with AudioSuite Plug-Ins

The AudioSuite Plug-Ins included with your Pro Tools system can be used to process and modify an audio region or entire audio file. You may do this in order to apply a specific AudioSuite process, such as Normalization or DC Offset Removal, that you know you will always want applied to the audio.

---

☞ Refer to the *DigiRack Plug-Ins Guide* for more information about AudioSuite Plug-Ins.

---

---

## Waveform Repair with the Pencil Tool

The Pencil tool allows you to destructively “redraw” waveform data. This tool is most commonly used to repair a pop or click in an audio file. A pop or click appears as a sudden sharp spike in a waveform. This tool only becomes active when the Edit window is zoomed in to the sample level.

▲ The Pencil tool is a destructive editing tool that permanently modifies the audio file on disk and should be used with caution.

---

Before using the Pencil tool, it is recommended that you create a backup copy of the target audio. You can do this by using the AudioSuite Duplicate Plug-In.

### To make a backup copy of an audio region:

- 1 Select the source region in the track’s playlist.
- 2 Choose AudioSuite > Duplicate.
- 3 In the AudioSuite dialog, make sure that “Playlist” is the processing preference, and that Use In Playlist is selected.
- 4 Click the Process button.

The AudioSuite Duplicate Plug-In creates a new audio file that is a duplicate of the original. The duplicate replaces the original on the track, and it is automatically named with the region name and the suffix “DUPL.”

### To destructively edit an audio waveform with the Pencil tool:

- 1 Locate the area you want to edit. Adjust the Track Height, as necessary, to edit the waveform with greater precision.
- 2 Using the Zoomer tool or the Vertical Zoom buttons, zoom down to the sample level so the waveform appears as a continuous thin line.

---

\* You can recall zoom levels with the Zoom Preset buttons (see “Zoom Preset Buttons” on page 149), or with Memory Locations (see “Memory Locations and Markers” on page 235).

---

- 3 Select the Pencil tool.



**Pencil tool**

**4** Carefully draw with the Pencil by dragging over the desired area of the waveform.

Don't over-edit or the results may be undesirable. You can use the Undo command to undo your previous edit.

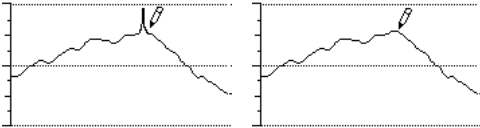

*Repairing a "pop" with the Pencil tool*

Try to limit editing to smoothing over a very small problem area, and keep the "fixes" in character with the shape of the surrounding wave.

**Part V**

**Mixing**



## chapter 19

# Basic Mixing

The following chapters cover the various steps in mixing a session, such as creating inserts and sends, adding effects, using automation, and bouncing tracks, all of which lead to the final mixdown.

Although the mixing process typically begins when you finish recording and editing, many mixing tasks can occur any time during a recording session.

## Using a Control Surface with Pro Tools

There are several optional control surfaces for Pro Tools:

- ◆ TDM-equipped Pro Tools systems can use Digidesign ProControl, a dedicated controller that provides access to all Pro Tools recording, mixing, editing, signal routing, Plug-In control, and automation features.
- ◆ All Pro Tools systems support MIDI control surfaces, including the Mackie HUI (Human User Interface), JL Cooper CS-10, Peavey PC-1600, and Penny & Giles MM-16 controllers.

☞ For more information on using MIDI control surfaces with Pro Tools, refer to the *Pro Tools MIDI Controllers Guide*.

## Creating Inserts and Sends

Pro Tools allows you to add both Inserts and Sends to tracks in your session. An *Insert* routes the signal from the channel to the effect of your choice and automatically returns it to the same channel. A *Send* also routes the signal from the channel to the destination of your choice, but to return the signal to the mix you must route it back into the session, either with an Auxiliary Input or by recording it onto a new track.

## The Inserts/Sends Editor

When you add an Insert or Send to a track, the Inserts/Sends Editor appears. This floating window allows you to edit Inserts and Sends for any track.

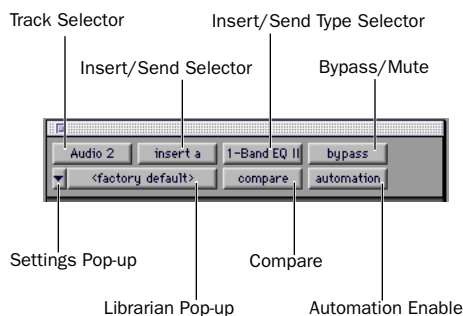

**Inserts/Sends Editor**

**Track Selector** Provides access to any Audio, Auxiliary Input, or Master Fader track.

**Insert/Send Selector** Provides access to any Insert or Send on the displayed track.

**Insert/Send Type Selector** Allows you to select any Hardware I/O channel, real-time Plug-In, or send destination for the displayed track.

**Settings Pop-Up menu** Provides access to commands for saving and importing Plug-In settings.

**Librarian Pop-Up Menu** Recalls settings files for real-time Plug-Ins.

**Compare Button** If you edit the settings of a Plug-In, this button allows you to compare the saved and edited settings.

**Bypass/Mute Button** On Inserts, this disables the currently displayed Plug-In, allowing you to hear the track with and without the effect. On Sends, this mutes the currently displayed Send.

**Automation Enable Button** (Real-time Plug-Ins only) Allows you to enable individual Plug-In parameters for automation recording. For more information, see “Automating Plug-Ins” on page 296.

---

## Inserts

Pro Tools allows you to place up to five unity-gain, pre-fader Inserts on each audio track, Auxiliary Input track, or Master Fader. (In the case of Master Faders, Inserts are post-fader only.) There are two types of Inserts, *Plug-In* Inserts and *Hardware I/O* Inserts.

Inserts do not alter the original audio source files, but process audio in real time, during playback. You can permanently apply real-time effects to tracks by recording or bouncing the effect to disk. When more than one Insert is used on a channel, they are processed in series, with each effect being added to the previous one, from top to bottom in the Mix window.

Because Pro Tools Inserts are pre-fader, you can cause clipping if you boost their gain to extremes, especially on tracks recorded at high amplitude. Watch on-screen metering to avoid clipping.

### Plug-In Inserts

Plug-In Inserts are software inserts that process audio material on a track in real time. The EQ, Dynamics, and Mod Delay Plug-Ins supplied with your Pro Tools system are real-time Plug-In Inserts. Refer to the *Digi-Rack Plug-Ins Guide* for details on using these Plug-Ins.

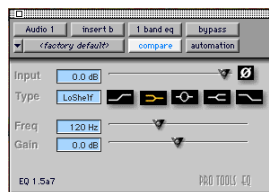

Real-Time Plug-In Insert (1-band EQ shown)

Additional real-time Plug-Ins are available from Digidesign and from many third-party developers.

### Hardware I/O Inserts

Hardware I/O Inserts allow you to route audio through an external device connected to the inputs and outputs of your Audio Interface. You can process the audio



material on a track with a hardware Insert in real time. For details, see “Hardware I/O Inserts and Sends” on page 277.



A Hardware I/O Insert

## Mono and Stereo Inserts

Inserts can be either mono or stereo. Stereo versions of Plug-Ins become available when you use them on a stereo channel. A stereo Hardware I/O Insert, which sends the signal to an input/output pair, can also be created on a stereo channel.

In addition, certain Plug-Ins (such as Mod Delay) allow you to generate stereo output from a mono channel. A channel made into stereo in this way has pan controls for each channel of the stereo signal. Any inserts that occur on a channel after a stereo insert are automatically used in stereo as well.

## Assigning Inserts to Tracks

Inserts can be used in two ways:

**On single tracks** An Insert can be applied to an individual audio track or Auxiliary Input using the Inserts pop-up menu on that track.

With in-line Inserts, you control the level of effect by adjusting the controls of the Plug-In or external device.

**As shared resources** An Insert can be used as a shared resource in a send-and-return arrangement, by bussing signals from several tracks to an Auxiliary Input, and then applying the Insert to the Auxiliary Input track. With such an arrangement, you can control the Send level for each track, and the overall level of the effect can be controlled from the Auxiliary Input track.

Shared arrangements allow you to make more efficient use of your system’s processing power. For more information, see “Applying an Insert to a Submix” on page 280.

### To show Inserts in the Mix Window:

- If Inserts are not visible on your tracks, select Display > Mix Window Shows > Inserts View.

### To add an Insert to a track:

- Click an Insert button on the track and choose an Insert from the pop-up menu.

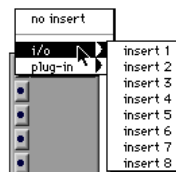

Selecting a Hardware I/O Insert

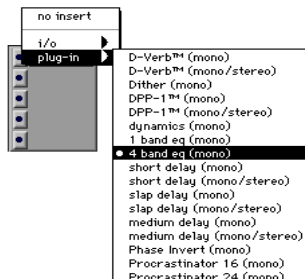

Selecting a Plug-In

## To remove an Insert from a track:

- Click the Insert button on the track and choose No Insert from the pop-up menu.

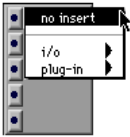

Removing an Insert

For details on the Plug-Ins included with your Pro Tools system, refer to the *DigiRack Plug-Ins Guide*.

## Using the Inserts Editor

In addition to the Inserts View in the Mix and Edit Windows, you can access the controls for Inserts directly from the Inserts/Sends Editor. The following examples show the Inserts/Sends Editor for a real-time Plug-In.

### To adjust the parameters for a Plug-In on a different track:

- Click the Track Selector button and choose a track from the pop-up menu.

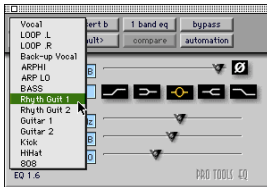

Selecting a track from the Inserts Editor

### To select a different Plug-In on the same track:

- Click the Insert Type Selector button and choose a Plug-In from the pop-up menu.

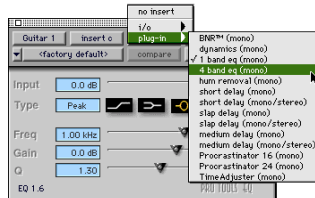

Selecting a Plug-In from the Inserts Editor

### To add another Plug-In to the same track:

- Click the Insert Selector button and choose an available Insert from the pop-up menu, then click the Insert Type Selector button and choose a Plug-In from the pop-up menu.

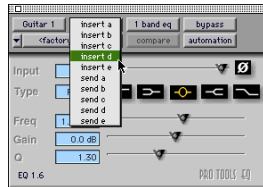

Selecting an Insert from the Inserts/Sends Editor

### To bypass a Plug-In Insert:

- Click the bypass button in the Inserts/Sends Editor  
– or –  
■ Option-click (Macintosh) or Alt-click (Windows) the Plug-In button in the Inserts View of the Mix window.

▲ You cannot bypass hardware inserts from Pro Tools. To monitor playback without a hardware insert, either set the Insert Type Selector to “No Insert” or use a bypass switch on the hardware device itself.

---

## Sends

Pro Tools allows you place up to five Sends on each audio or Auxiliary Input track. You can set Sends to be either pre- or post-fader. When you create a new Send, its output level is automatically set to  $-\infty$ .

---

\* You can set the Send output level to zero by Option-clicking (Macintosh) or Alt-clicking (Windows) the Send fader.

---

Sends are typically returned to the mix by means of an Auxiliary Input. They can also be recorded directly onto another track. There are two types of destinations for Sends: *Internal Mix Busses* and *Hardware I/O Sends*.

### Internal Mix Busses

Pro Tools TDM systems provide 32 busses and Pro Tools LE systems provide 16 busses for routing signals internally to other destinations, including real-time Plug-Ins.

### Hardware I/O Sends

Hardware I/O Sends are often used for headphone cue mixes or for sending signals to external effects processors. See “Hardware I/O Inserts and Sends” on page 277.

### Mono and Stereo Sends

Sends can be either mono or stereo. When you click the Sends button on a channel, you can choose from a list of mono or stereo outputs or busses. Send level, Send

Mute, and Send Pan (for stereo Sends) parameters are fully automatable. See “Automating Sends” on page 295.

## Assigning Sends to Tracks

### To show Sends in the Mix Window:

- 1 If Sends are not currently visible on your tracks, select Display > Mix Window Shows > Sends View.
- 2 Select Display > Sends View Shows > Assignments to show all the Sends buttons on the tracks.

### To add a Send to a track:

- 1 Click the Sends button on the track and choose a Send from the pop-up menu.

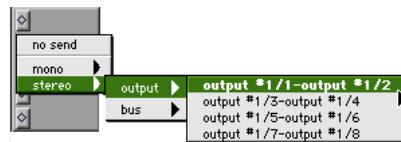

### Assigning a hardware stereo Send

The Send can be either a mono or stereo Send, and can have a destination of an internal mix bus or a hardware I/O output.

- 2 Set the output level of the Send.

### To remove a Send from a track:

- Click the Sends button on the track and choose No Send from the pop-up menu.



### Removing a Send

## Using the Sends Editor

In addition to the Sends View in the Mix and Edit Windows, you can access the controls for Sends directly from the Inserts/Sends Editor.

### To display Sends for a different track:

- Click the Track Selector button and choose a track from the pop-up menu.

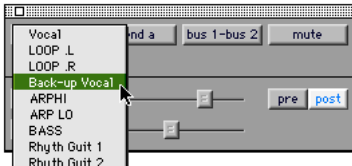

Selecting a track from the Sends Editor

### To select a different send destination for a track:

- Click the Send Destination Selector button and choose a send destination from the pop-up menu.

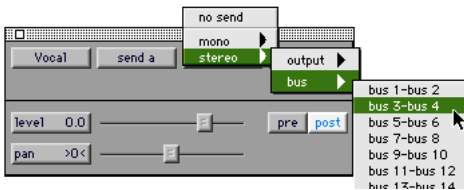

Selecting a send destination from the Sends Editor

### To add an additional Send to the same track:

- Click the Send Selector button and choose the desired Send from the pop-up menu, then click the Send Destination selector and choose a destination from the pop-up menu.

### To display the controls for a different Send on the same channel:

- Click the Send Selector button and choose the desired Send from the pop-up menu.

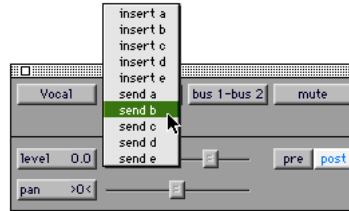

Accessing another Send from the Sends Editor

## Displaying Send Controls

You can display all the parameters of an individual Send in the Sends area of the Mix and Edit Windows, allowing full access to all controls for that Send on all channels. When you display the controls for an individual Send, you also have the option of displaying Send level meters.

### To display the controls for an individual Send across all channels:

- 1 If Sends are not currently visible on your channels, choose Display > Mix Window Shows > Sends View.
- 2 Choose Display > Sends View Shows and choose an individual Send.



Sends view controls for an individual stereo Send

### To display Send level meters when viewing individual Sends:

- 1 Choose Setups > Preferences and click Display.
- 2 Select Show Meters in Sends View and click OK.

Send level meters show peak values and indicate clipping that occurs while the meter is displayed (if a Send clips any time before its meter is displayed, this is not shown). To clear a Send meter's clip indicator, click on it.

---

\* If you are using a slower computer, hiding Send level meters can improve screen redraw times.

---

## Copying Track Control Settings to Sends

### (TDM Systems Only)

Sometimes you may want Send settings to match the settings in the track itself—for example, to send a headphone mix based on the main mix. You can quickly copy a track's volume fader, pan slider, or mute button position to the corresponding controls for a Send on that track.

In addition, you can copy the entire automation playlist for the selected control to the corresponding playlist for the Send. See “Copying Track Automation to Sends” on page 295.

### To copy a track's current control settings to a Send on that track:

- 1 Select the tracks you want to edit by clicking on the track names to highlight them.
- 2 Choose Edit > Copy To Send.

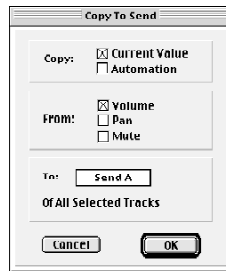

The Copy to Send dialog

- 3 In the Copy to Send dialog, select Current Value to copy the current position of the track controls.
- 4 Choose the controls you want to copy.
- 5 Choose which Send to copy the settings to, and click OK.

---

## Auxiliary Inputs

Auxiliary Inputs function as inputs for both internally bussed signals and external sources such as tape machines or live sources. They also function as returns for shared internal Plug-In effects and external effects processors.

You can automate the level, muting, and panning of an Auxiliary input track, and you can apply Inserts and Sends to it as well.

Auxiliary Inputs do not provide an input gain stage, so if you are using them as inputs for external sources, you must match levels between the external devices and your Audio Interfaces. When you create a new Auxiliary Input, its main fader level is automatically set to  $-\infty$ .

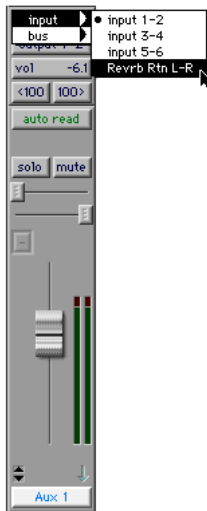

*Auxiliary Input used as an input for external sources*

You can create mono or stereo Auxiliary Inputs, depending on which type of signal you are working with.

#### **To create an Auxiliary Input:**

- 1 Choose File > New Track.
- 2 Choose the type of Auxiliary Input (mono or stereo) from the pop-up menu.
- 3 Enter the number of tracks and click Create.
- 4 Click the Input selector of the Auxiliary Input channel and choose an input source.

5 Click the Output selector of the Auxiliary Input channel and choose an output.

6 Set the Auxiliary Input level.

## **Using an Auxiliary Input as an Auxiliary Return**

You can use an Auxiliary Input to return a signal sent to an internal mix bus or to an external device.

#### **To create an Auxiliary Return for an internal mix bus:**

- 1 Set the send destinations on the source tracks to a mix bus (for a mono Send) or a bus pair (for a stereo Send).
- 1 Choose File > New Track.
- 2 Choose the matching type (mono or stereo) of Auxiliary Input from the pop-up menu, and click Create.
- 3 Click the Input Selector of the Auxiliary Input channel and set it to the bus you want to return.
- 4 Add a real-time Plug-In Insert or a Hardware I/O Insert to the Auxiliary Input track.
- 5 Click the Output Selector of the Auxiliary Input channel and choose an output.

Set the Plug-In effect or external device controls to “100% wet.” You can then adjust the level of the processed signal in the mix with the main fader of the Auxiliary Input track.

## Generating Stereo Output from a Mono Send/Return

You can use an Auxiliary Return arrangement to generate a stereo output from a mono Send. Set the send destination to a mono Auxiliary Input track and place a stereo Plug-In on the Auxiliary Input. The output of the Auxiliary Input becomes stereo.

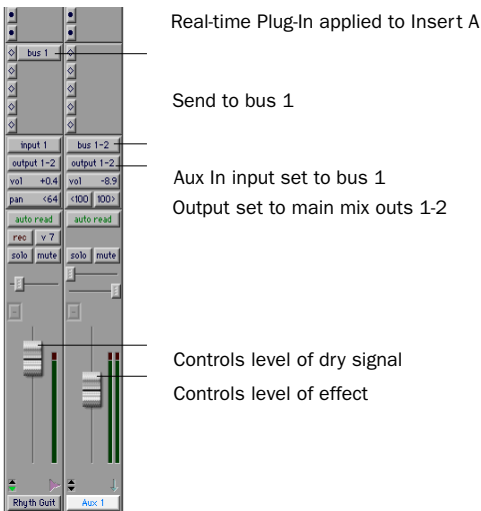

Real-time Plug-In applied to Insert A

Send to bus 1

Aux In input set to bus 1

Output set to main mix outs 1-2

Controls level of dry signal

Controls level of effect

Send/return setup for a Internal Mix Bus

### To create an Auxiliary Return for an external device:

- 1 Set the send destinations on the source tracks to a Send output (for a mono Send) or a Send output pair (for a stereo Send).
- 1 Choose File > New Track.
- 2 Choose the type (mono or stereo) of Auxiliary Input from the pop-up menu, and click Create.
- 3 Click the Input Selector of the Auxiliary Input channel and set it to the Hardware I/O channel that you want to return.

- 4 Click the Output Selector of the Auxiliary Input channel and choose an output.

Set the effect on the external device to “100% wet.” You can then adjust the level of the processed signal in the mix with the main fader of the Auxiliary Input track.

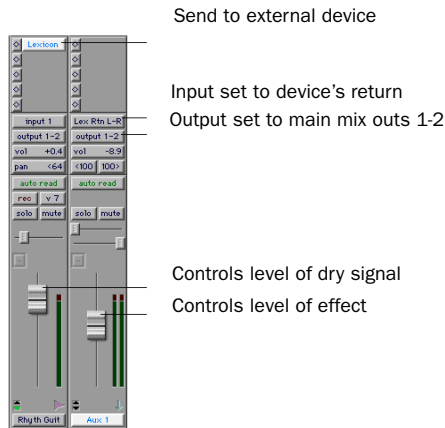

Send to external device

Input set to device's return

Output set to main mix outs 1-2

Controls level of dry signal

Controls level of effect

Send/return setup for an external device

## Master Faders

Master Faders allow you to control the master output levels of two types of signals in a Pro Tools system:

- Signals sent to the outputs of the Audio Interface
- Signals sent to any of the internal busses

Master Faders can be either mono or stereo and have many applications, including:

- Controlling output mix levels
- Monitoring an output (such as a bus or hardware output) to see if it is clipping
- Controlling submix levels
- Controlling effects sends levels

- Controlling submaster (bussed tracks) levels while bouncing to disk in real time
- Applying Dither to an entire mix

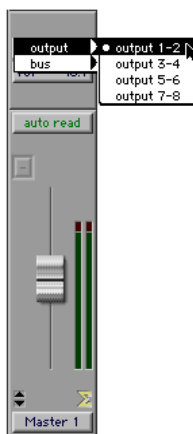

**Master Fader used to control master levels of Audio Interface outputs**

Unlike Inserts on Audio or Auxiliary Input tracks, Master Fader Inserts are post-fader. This allows you to insert a DSP dither Plug-In, such as DigiDesign's noise-shaped dither, to your master mix, and dither the signal properly during a fade.

---

☞ Refer to the *DigiRack Plug-Ins Guide* for details about using Dither.

---

On both TDM and LE-based systems, you can use Master Faders freely to control sub-mix levels, send level masters and other outputs because they do not consume any of your system's audio processing power.

**To create a Master Fader:**

- 1 Choose File > New Track.
- 2 Choose the type of Master Fader (mono or stereo) from the pop-up menu.

- 3 Enter the number of tracks and click Create.

- 4 Click the Master Fader's Output selector and choose the output that you want to control. You can choose either Audio Interface outputs or internal busses. If the Master Fader is a stereo fader, you can control the level of a pair of outputs.

**To use Master Faders as a master volume control for all channels in a session:**

- 1 Choose File > New Track.
- 2 Choose the type of Master Fader from the pop-up menu.
- 3 Click Create.
- 4 Set the output of the Master Fader to the output channels to outputs 1–2.
- 5 Set the outputs of all audio tracks in the session to outputs 1–2 and set the panning of each track.

The Master Fader controls the output levels of all tracks routed to it. You can write automation for the Master Fader and it applies to your entire session.



# Advanced Mixing

---

## Hardware I/O Inserts and Sends

You can connect external devices, such as reverb or effects processors, to your Pro Tools system and use them as inserts or make them the destination for effects sends and returns.

You can also label the connections so that the device name appears in the I/O pop-up menus in Pro Tools.

## Connecting External Devices

Pro Tools TDM and Digi 001 systems allow you to create dedicated connections to external analog or digital devices. The number and type of connections depends on what kind of system you have.

You can also use the inputs and outputs of an Audiomeia III card to connect external devices. You can send and return an analog signal using the analog connectors on the card, and monitor through a DAT machine connected to the digital output. You can also send and return a digital signal to an

external device that supports digital I/O (such as a reverb unit), and monitor with the analog outputs.

### To connect an external device to a Pro Tools system:

- 1 Connect an unused output (or pair of outputs for a stereo device) of your Pro Tools system to an input of the external signal processor.
- 2 Connect the output of the external signal processor to an unused input (or pair of inputs for a stereo device) of your Pro Tools system.

If you plan to use a device as an Insert, be sure to connect the device to matching inputs and outputs on your system.

---

☞ For details on connecting external devices, refer to the *Pro Tools Hardware Installation Guide* that came with your system.

---

## To label hardware I/O Inserts or Sends:

- 1 Choose Setups > I/O Labels.

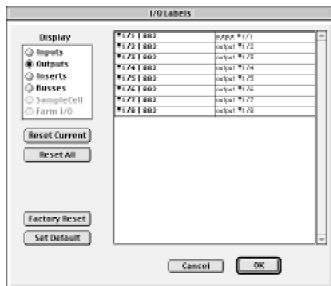

The I/O Labels dialog

- 2 Under Display, click Inserts (for hardware inserts), or Outputs (for hardware sends) and name the connections carrying signal to the external device (for example, *Reverb.L* and *Reverb.R*).

- 3 Click Inputs and name the connections carrying signal from the device in the same manner (for example, *Reverb Return.L* and *Reverb Return.R*).

- 4 When you have finished, click OK.

For more information on I/O labels, see “Assigning Track Inputs” on page 53 and “Assigning Track Outputs” on page 54.

## Connecting Effects Units Digitally

If you want to use the digital inputs and outputs on your Pro Tools system as effects sends and returns to a digital effects device, Pro Tools should be the clock master in most cases. Set your digital effects device to accept an external digital clock so that it synchronizes to Pro Tools.

## To set up a digital send to an external device, do the following for your system:

### TDM Systems

- 1 Choose Setups > Hardware Setup.

- 2 Do one of the following:

- ◆ On an 888/24 I/O Interface, choose Setups > Hardware, click Other Options, and set the channel pair to Digital.

- ◆ On an 882/20 I/O or 1622 I/O Interface, choose Setups > Hardware and set Channel 1–2 input to Digital.

- 3 Choose Internal from the Sync Mode pop-up menu.

- 4 Click OK.

### Digi 001 Systems

- 1 Choose Setups > Playback Engine and click Other Options.

- 2 Do one of the following:

- ◆ If the external device is connected to the S/PDIF RCA jacks, deselect S/PDIF Mirroring. (When S/PDIF Mirroring is on, digital output at the S/PDIF RCA jacks exactly mirrors the output of analog Channels 1–2.)

- ◆ If the external device is connected to the Optical ports, choose a format (most likely S/PDIF for an effects device) from the Optical Format pop-up menu.

- 3 Choose Internal from the Sync Mode pop-up menu.

- 4 Click OK.

- 5 Choose Setups > I/O Labels.

- 6 Under Display, click Outputs and then click Factory Reset to update the output label configuration. Enter new names for the Output I/O labels.

**7** Click Inputs and then click Factory Reset to update the input label configuration. Enter new names for the Input I/O labels.

**8** Click OK.

---

▲ If you set the Optical Format to S/PDIF, Pro Tools will watch the Optical port for any audio input on the S/PDIF RCA jacks.

---

## **Audiomedia III Systems**

**1** Choose Setups > Playback Engine and deselect S/PDIF Mirroring. (When S/PDIF Mirroring is on, digital output at the S/PDIF RCA jacks exactly mirrors the output of analog Channels 1–2.)

**2** Choose Internal from the Sync Mode pop up menu.

**3** Click OK.

**4** Choose Setups > I/O Labels.

**5** Under Display, click Outputs and then click Factory Reset to update the output label configuration. Enter new names for the Output I/O labels.

**6** Click OK.

## **Using external clock sources**

Pro Tools uses the digital input on Channels 1–2 as its clock master. To synchronize your system to an external clock source, connect the external source to digital inputs 1–2 of your system.

## **TDM Systems**

Pro Tools can receive external clock from Channels 1–2, using either the AES/EBU (on the 888/24 I/O) or S/PDIF connectors on your Audio Interface.

In an expanded TDM system, connect to the digital input on Channels 1–2 of the master Audio Interface. This is the Audio Interface connected to the first MIX, d24, or Disk I/O card in your system.

---

☞ Refer to the *Pro Tools TDM System Installation Guide* to determine correct card order and Audio Interface connections for TDM systems.

---

### **To select an external clock source for a TDM system:**

- 1** Choose Setups > Hardware.
- 2** Set the Sync Mode to Digital.
- 3** Choose the Digital Format for the input.

## **Digi 001 Systems**

Pro Tools can receive external clock from the optical input (on the Digi 001 PCI card) or S/PDIF input (on the Digi 001 I/O box).

### **To select an external clock source for a Digi 001 system:**

- 1** Choose Setups > Hardware.
- 2** Set the Sync Mode to match the type of input.

If you choose Optical, make sure the Optical Format matches the type of optical input you are sending to your Pro Tools system.

---

▲ If you set the Optical Format to S/PDIF, Pro Tools will watch the Optical port for external clock, and ignore any clock input on the S/PDIF RCA jacks.

---

## Audiomedia III Systems

Pro Tools can receive external clock from the S/PDIF input on the Audiomedia III card.

### To select an external clock source for an Audiomedia III system:

- 1 Choose Setups > Hardware.
- 2 Set the Sync Mode to match the type of input.

---

## Creating a Submix

You can use an Auxiliary Input to create a submix by sending the output of several tracks to the Auxiliary Input instead of to the main mix outputs of your session.

You can then apply real-time Plug-Ins to the submix or send the submix to an external processor by using Inserts or Sends on the Auxiliary Input track.

The following example illustrates how to create a stereo submix group.

### To create a submix:

- 1 Choose File > New Track and choose Aux Input (stereo) from the pop-up menu.
- 2 Set the output of the tracks you want to include in the submix to a bus pair and set the panning of each track.
- 3 Set the input of the Auxiliary Input track to the same bus pair.
- 4 Set the output of the Auxiliary Input track to your main stereo mix outputs (typically, outputs 1–2).
- 5 Set the Auxiliary Input level.

The Auxiliary Input track controls the output levels of all tracks routed to it. You can apply mix automation to the Volume, Pan, Mute, and Send Level, Send Pan, and Send Mute controls of the Auxiliary Input.

You can also bounce a submix to disk to free up the voices for use by other tracks. See “Recording a Submix to Disk” on page 282.

## Soloing Tracks in a Submix

When you want to solo any tracks in a submix, you can solo-safe the Auxiliary Input track. This allows you to solo tracks that are bussed to the Auxiliary Input without having to solo the Auxiliary Input as well.

### To solo-safe an Auxiliary Input:

- Command-click (Macintosh) or Control-click (Windows) the Solo button on the Auxiliary Input track.

## Applying an Insert to a Submix

You can use a real-time Plug-In or a hardware I/O insert as a shared resource for all tracks included in a submix. This allows you to control an effect such as EQ on multiple tracks (such as stereo pairs) with a single set of controls. This also makes the most efficient use of your system’s processing power, as it saves you from having to apply the same Plug-In to each track separately.

**To apply an Insert to all tracks in a stereo submix:**

- 1 Choose File > New Track and choose Aux Input (stereo) from the pop-up menu.
- 2 Set the output of the tracks you want to include in the submix to a bus pair and set the panning of each track.
- 3 Set the input of the Auxiliary Input track to the same bus pair.
- 4 Set the output of the Auxiliary Input to the main mix outputs.
- 5 On the Auxiliary Input track, click the Inserts pop-up and select a Plug-In.
- 6 In the Inserts/Sends Editor, set the parameters of the DSP Plug-In.

---

## Using an Auxiliary Input to Mix an External Source

You can use an Auxiliary Input to bring an external audio source (such as tape, instruments, or any live source) into a Pro Tools mix.

**To use Auxiliary Inputs to bring external audio sources into a mix:**

- 1 Connect the audio outputs of your external audio source to available inputs on your system.
- 2 Choose File > New Track and choose the type of Auxiliary Input (mono or stereo) from the pop-up menu, then click Create.
- 3 Set the input of the Auxiliary Input track to the system input.
- 4 Click the Output selector of the Auxiliary Input channel and choose an output.
- 5 Set the Auxiliary Input level.

You can apply real-time Plug-Ins to the audio signal or route it through an external device by using the Inserts or Sends on the Auxiliary Input track. You can also apply mix automation to the Volume, Pan, Mute, Send Level, Send Pan, and Send Mute controls of the Auxiliary Input just as you can with an audio track.

---

## Creating a Master Send Level Control

You can use a Master Fader to control the send level of multiple tracks being sent to an Auxiliary Input or to an external signal processor.

**To create a Master send level control:**

- 1 Choose File > New Track and choose Master Fader (mono or stereo) from the pop-up menu, then click Create.
- 2 Do one of the following:
  - ◆ Set the output of the Master Fader to match the bus (or bus pair) that you are using to send to an Auxiliary Input track containing a Plug-In.
  - ◆ Set the output of the Master Fader to match the output destination (or output pair) that you have chosen for your effects send.

You can then set the relative send levels on each of the source tracks, and use the Master Fader as a master level control for the signal you are sending to an Auxiliary Input with a Plug-In or external hardware device.

---

## Printing Effects to Disk

By using the Bounce to Disk command, or by bussing tracks with effects to audio track inputs, you can *print effects to disk*. This is the technique of permanently adding an effect, such as EQ or reverb, to an audio track by re-recording it to disk with the effect added. The original audio is preserved, so you can return to the source track at any time.

This method of adding effects is useful when you have a limited number of tracks or effects devices.

When you print an effect to disk, you can control the amount of the effect by adjusting any of the following:

- ◆ Settings of the Sends on the original dry tracks
- ◆ Level of the Auxiliary Input being used as a return
- ◆ Wet/dry control on the Plug-In or effects device

You can print effects to disk in two ways:

- ◆ By bouncing the output of your session using the Bounce to Disk command. For details, see “Bouncing Tracks to Disk” on page 313.
- ◆ By creating a submix in your session and re-recording it to disk. See “Recording a Submix to Disk” on page 282.

---

## Recording a Submix to Disk

You can create a submix in your Pro Tools session and re-record it to available tracks in the same session. Recording a submix to disk in this way requires an available voice for each track that you want to re-record. Make sure you have enough voices available to play back all tracks that you want to re-record and enough voices available to record the destination tracks.

This technique lets you add live input (such as vocals or MIDI instruments) to the mix, as well as allowing you to manually control volume, pan, mute, and other controls during the recording process.

In contrast, the Bounce to Disk command allows you to bounce all available voices to disk without holding any in reserve, but you cannot manually change any controls during the bounce. See “Bouncing Tracks to Disk” on page 313 for more information.

### To print effects to disk by bouncing a submix:

- 1** Apply any Plug-Ins or external processors you want to add to your audio tracks or Auxiliary Inputs before you record.
- 2** Set the output of the tracks you want to include in the submix to a bus or bus pair. If you are recording in stereo, set the panning of each track.
- 3** Choose File > New Track and choose Audio Track from the pop-up. If you are recording in stereo, create two new tracks.

- 4 If you are recording in stereo, set the panning of the new tracks to full left and right.
- 5 Set the input of each destination track to match the bus or bus pair to which you are recording.
- 6 Set the output of your new tracks to your main output pair.
- 7 Position the playback cursor or make a selection where you want to begin playback.
- 8 Record enable the new tracks and click Record in the Transport window.
- 9 Click Play in the Transport window to begin recording the submix.
- 10 Click Stop when you are finished recording.

---

## TDM Mixer Plug-Ins

### (TDM Systems Only)

Pro Tools TDM systems come with two different Mixer Plug-Ins: 16-bit Optimized and 24-bit Optimized. In most cases, the Mixer Plug-In that was automatically installed with your system is the best one for all around use. The Mixer Plug-In that is installed depends on which Pro Tools system you have:

**Pro Tools 24 MIX and Pro Tools 24** The 24-bit Optimized Mixer Plug-In is installed by default. When you run your Pro Tools Installer, a copy of the 16-bit Optimized Mixer is placed in the folder “Plug-Ins (Unused)”.

**Pro Tools III** The 16-bit Optimized Mixer is installed by default. When you run your Pro Tools Installer, a copy of the 24-bit Optimized Mixer is placed in the folder “Plug-Ins (Unused)”.

The Pro Tools Session Setup window indicates which of the two Mixer Plug-Ins is currently installed.

## Mixer Plug-In Features

### The 24-bit Optimized Mixer

The 24-bit Optimized Mixer provides:

- ◆ Optimized performance for recording and mixing 24-bit audio
- ◆ 24-bit digital output mix result from an Audio Interface output or when bouncing to disk. Mixing level scaling stores 48-bit results using a 56-bit accumulator for maximum precision.
- ◆ Fewer mixing channels (On TDM systems, 26 x 2 mixing channels can be created per DSP)
- ◆ 30 dB of mix headroom
- ◆ Input and Output clip indication: Master Fader meters simultaneously indicate clipping at both the input summing stage and the output level stage.

### The 16-bit Optimized Mixer

The 16-bit Optimized Mixer provides:

- ◆ Optimized performance for recording and mixing 16-bit audio
- ◆ 24-bit digital output mix result from an Audio Interface output, or when bouncing to disk

- ◆ More mixing channels (On TDM systems, 36 x 2 mixing channels can be created per DSP)
- ◆ 18 dB of mix headroom
- ◆ Output clip indication: Master Fader meters indicate clipping at the input summing stage only.

## Choosing a Mixer Plug-In

**Pro Tools 24 MIX and Pro Tools 24** Always use the 24-bit Optimized Plug-In with Pro Tools 24 MIX systems, regardless of the bit depth of your session.

**Pro Tools III** In most cases, use the 24-bit Optimized Plug-In when working with 24-bit audio and the 16-bit Optimized Plug-In when working with 16-bit audio.

## Using the 16-Bit Optimized Mixer for 24-bit Recording or Mixing

### (Pro Tools III Systems Only)

In cases where you want to maximize the channel capacity of in a Pro Tools III session, you can use the 16-bit Optimized Plug-In for mixing 20- or 24-bit audio.

Every mixer connection in a Pro Tools session, including internal bussing and sends, uses processing capacity. Since the 16-bit Optimized Mixer uses less processing power per mixing channel, you can use it to maximize the number of mixer channels in your session.

If the 16-bit Optimized Mixer receives an input signal with greater than 20-bit resolution from an Audio Interface, its input level scaling processes only the most-significant 20 bits, and ignores the bottom four bits.

However, the 16-bit Optimized Mixer internal mix bus still processes signals with 24-bit precision, and can produce a 24-bit digital output mix result from an Audio Interface digital output or when bouncing to disk.

## Switching TDM Mixer Plug-Ins

### To Switch TDM mixer Plug-Ins:

- 1 Quit Pro Tools.
- 2 Open the DAE Folder. The DAE folder is installed at the root level of the System Folder.
- 3 Open the “Plug-Ins (Unused)” folder, locate the Mixer Plug-In that is not in use, and drag it to the Plug-Ins folder.
- 4 Open the Plug-Ins folder, locate the other mixer Plug-In, and drag it to the “Plug-Ins (Unused)” folder.
- 5 Launch Pro Tools.

## Preventing Clipping

The 24-bit Optimized and the 16-bit Optimized Mixer Plug-Ins indicate clipping differently.

**24-bit Optimized Mixer** With the 24-bit Optimized mixer, the Master Fader meters indicate clipping at *both* the input summing stage and the output level stage at all times. With this mixer, you could lower the Master Fader to reduce your output level, but the Master Fader meters could still indicate clipping at the input stage.

**16-bit Optimized Mixer** With the 16-bit Optimized Mixer, the Master Fader meters indicate clipping *only* for the output level stage of the mixer. With this mixer, you



could lower the Master Fader to reduce your output level, but any clipping at the input stage would not be indicated.

If reducing the output level has no effect on clipping, it could be occurring in one of the following places:

- ◆ At the input summing stage. To prevent clipping at the input stage, trim the input summing levels.
- ◆ At an insert on the Master Fader. If you are using a Plug-In on the Master Fader, its meters show the levels on the Insert. To prevent clipping at the Insert, trim levels on any Plug-Ins or Hardware Inserts on the Master Fader.

### **Trimming Input Summing Levels**

With many inputs that contain hi-level signals, it is possible to clip the input summing stage of the 16-bit Optimized Mixer. (This is less likely to happen on the 24-bit Optimized Mixer because of its much greater available headroom.)

To reduce the levels going into the input summing stage of the Mixer Plug-In, lower the fader levels of all track faders using the All Mix/Edit group. If you are using mix automation, you will need to use Automation Trim mode or the Trim tool to lower the overall volume of all tracks until the levels are low enough to not overload the Master Faders.



# Automation

Pro Tools features dynamic automation of volume, pan, and mute controls for audio tracks, Sends, and MIDI tracks, as well as real-time Plug-In parameters. In Pro Tools, you can write automation moves in real time during playback of your session. You can also edit automation data with the same techniques you use to edit audio and MIDI data.

## Using Control Surfaces

**ProControl** Digidesign's ProControl supports all automation features in Pro Tools. ProControl DigiFaders™ provide 10-bit accuracy, or 1,024 steps of resolution. Pro Tools interpolates this ProControl input and provides 24-bit resolution of Volume and Send automation on playback.

---

☞ For details on using ProControl to create mix automation, refer to the *ProControl User's Guide*.

---

**MIDI Controllers** Most MIDI control surfaces have 8-bit resolution, or 128 steps; the Mackie HUI has 9-bit resolution, or 512 steps. Pro Tools interpolates this input to a much higher resolution on playback, resulting in fader automation that is smooth enough to satisfy professional requirements.

## Automation Playlists

Each Pro Tools track contains a single automation playlist for each automatable control.

On audio tracks, these controls include:

- Volume
- Pan
- Mute
- Send Volume, Pan, and Mute
- Plug-In parameters

On MIDI tracks, these controls include:

- Volume
- Pan
- Mute

You can display and edit each of these automatable parameters individually from Pro Tools, even during playback.

In addition, you can display and edit other continuous MIDI controller data (such as Mod Wheel, Breath Controller, Foot Controller, or Sustain) in a similar manner. For more information on editing MIDI data, see “Continuous Controller Events” on page 207.

## Edit Playlists and Automation

Pro Tools handles audio regions and playlists differently from MIDI regions and playlists.

### Audio Tracks

On audio tracks, automation data resides on a separate playlist from audio data and regions. Each edit playlist on an audio track shares the same automation data.

When you trim audio regions with the Trim tool, the underlying automation data remains unchanged.

### MIDI Tracks

On MIDI tracks, all controller automation data *except for Mute data* is contained in the MIDI region that it was recorded in. Each edit playlist on a MIDI track is separate, and represents a distinct performance, complete with controller automation.

When you trim MIDI regions with the Trim tool, the controller automation data is trimmed with the other MIDI data.

---

▲ Mute data is independent of the MIDI data in a MIDI region. This allows you to mute playback of individual MIDI tracks in Pro Tools without altering the controller data.

---

## Multiple Edit Playlists and Audio Tracks

All edit playlists on a single audio track share the same automation data. When you copy or cut audio data from a track while it is in Waveform view, the underlying automation data is cut or copied with it. If you paste audio data from other locations or tracks into an edit playlist, you may change the underlying automation data on the track.

If you are using multiple edit playlists to assemble different versions of your audio tracks, you can avoid problems with automation by editing and assembling the audio tracks before applying automation to them.

---

## Automation Modes

Automation modes control how automation data is written and played back.

### Auto Off

Auto Off mode turns off automation for all automatable controls:

- Volume
- Pan
- Mute
- Send Volume, Pan, and Mute
- Plug-In parameters
- MIDI Volume
- MIDI Pan
- MIDI Mute

In Auto Off mode, automation data for these parameters is ignored during playback. All other MIDI controller data is sent.

## Auto Read

Auto Read mode plays the automation that was previously written for a track.

## Auto Touch

Auto Touch mode writes automation only while a fader or switch is touched or clicked with the mouse. When the fader is released, the writing of automation stops and the fader returns to any previously automated position, at a rate determined by the AutoMatch and Touch Timeout settings. See “AutoMatch” and “Touch Timeout” under “Automation Preferences” on page 291.

In Auto Touch mode, certain control surfaces start writing automation as soon as you touch them. These include:

- ◆ Touch-sensitive motorized fader controllers, such as Digidesign ProControl, or the Mackie HUI.
- ◆ Continuous-belt controllers, such as the Penny & Giles DC16/MM16.

With other control surfaces in Auto Touch mode, writing of automation does not begin until the fader hits the *pass-through point*, or the previously automated position. Once you reach pass-through point with the fader, writing of automation begins and continues until you stop moving the fader.

## Auto Latch

Auto Latch mode works in the same way as Auto Touch mode, writing automation only if you touch or move a control. However, unlike Auto Touch, writing of automation continues until you stop playback.

This mode is particularly useful for automating Pan controls, Plug-Ins, or for using a MIDI control surface, since it does not time out and revert to its previous position if you release a control.

## Auto Write

Auto Write mode writes automation from the time playback starts to the time it stops, erasing any previously written automation for the duration of the automation pass.

After an automation pass, Pro Tools automatically switches from Auto Write mode to Auto Touch mode. This prevents you from accidentally overwriting automation data on later playback. On TDM systems, you can turn off this behavior and remain in Auto Write mode. See “Write Switches To Touch After Pass” on page 292 for details.

## Trim Mode

### (TDM Systems Only)

Pro Tools TDM systems allow you to adjust (or *trim*) existing track Volume and Send Level automation data in real time. Pan and Plug-In automation cannot be trimmed in this manner. Trim mode is useful when you want to preserve all of your volume automation moves, but need to make levels a bit louder or softer to balance a mix.

When editing automation in Trim mode, fader moves write *relative* rather than *absolute* values. The existing automation data is changed by the amount of increase or decrease (or the *delta* value) indicated by the faders. When trimming, a track’s Volume

indicator or Send Level indicator shows the delta values being written rather than the absolute value.

Trim mode works with the other automation modes (Auto Read, Auto Touch, Auto Latch, Auto Write) to affect how delta values are written to existing automation data. When Trim mode is enabled, *non-trimmable* controls behave in the same manner as in the standard automation modes, with the exception of Trim/Auto Write mode, where non-trimmable controls operate as in Auto Touch mode.

### **Trim/Auto Off**

Trim/Auto Off mode turns off automation and trimming for a track. All automation moves are ignored during playback.

### **Trim/Auto Read**

In Trim/Auto Read mode, Volume and Send faders follow the previously written automation. When one of the faders is touched, the trim moves (delta values) are played back, but are not written into the automation data. This allows you to audition trim moves without affecting existing automation.

When this mode is enabled, non-trimmable controls (all controls other than track Volume and Send Level) behave as if they are in regular Read mode—no automation data is written.

### **Trim/Auto Touch**

In Trim/Auto Touch mode, when playback begins, Volume and Send faders follow the previously written automation. When one of the faders is touched, real-time trimming begins. Fader moves write delta values (an increase or decrease in existing automation data).

When the fader is released, trimming stops and the fader returns to a zero delta value and continues to follow the previously written automation. The rate of the fader's return to a zero delta value is determined by the AutoMatch Time specified in the Automation Preferences.

When this mode is enabled, non-trimmable controls (all controls other than track Volume and Send Level) behave as if they are in regular Auto Touch mode—they follow the previously written automation until touched. When they are touched, their absolute positions are written until the control is released or until playback stops.

### **Trim/Auto Latch**

In Trim/Auto Latch mode, when playback begins, Volume and Send faders follow the previously written automation. When one of the faders is touched, real-time trimming begins. Any fader moves after trimming begins increase or decrease existing automation data accordingly. Trimming of the touched control continues until playback stops.

When this mode is enabled, non-trimmable controls (all controls other than track Volume and Send Level) behave as if they are in regular Latch mode—they follow the previously written automation until

touched. When they are touched, their absolute positions are written until playback is stopped.

## Trim/Auto Write

In Trim/Auto Write mode, the Volume and Send Level faders are disengaged from displaying the existing automation data, so you don't have to chase them during playback. Faders are automatically positioned at 0 dB, where no trimming occurs (they start with a delta value of zero). From this reference point you can then set the initial delta values before initiating playback.

In this mode, as soon as playback begins, delta values are applied to the existing automation data. Trimming continues until playback stops.

When Trim/Auto Write mode is enabled, non-trimmable controls (all controls other than track Volume and Send Level) are not in Write mode, but behave as if they are in *regular Auto Touch mode* (no automation is written unless a control is touched). This is to prevent the controls from overwriting all of their automation data on every pass in Trim mode.

---

▲ In Trim Mode, tracks do not automatically change from Trim/Auto Write to Trim/Auto Touch after an automation pass. Be sure to switch out of Auto Write when you leave Trim mode to avoid overwriting automation data.

---

## Automation Preferences

Pro Tools gives you several options for controlling the writing and playback of automation data.

### To display Automation Preferences:

- Choose Setups > Preferences, and click Automation.

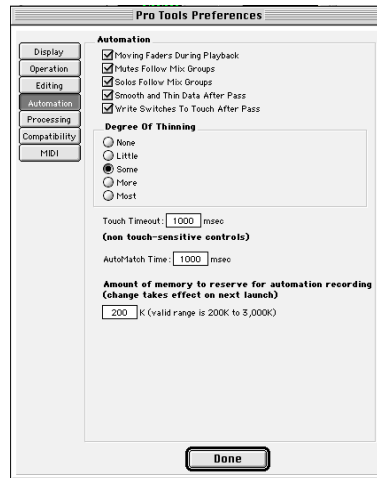

Automation Preferences dialog

**Moving Faders During Playback** When this option is selected, on-screen faders move if automation has been written for them. When this option is deselected, automation still operates, but on-screen faders do not move. Turning this option off can help speed up screen redraws and processing if you are using a slower computer.

**Mutes Follow Mix Groups** When this option is selected, muting a track/channel that belongs to a group mutes all other members of the group. When this option is deselected, tracks/channels must be muted on an individual basis. When this option is se-

lected, you can still mute/unmute individual group members by Control-clicking (Macintosh) or Right-clicking (Windows) the mute button of the channel you want to affect individually.

**Solos Follow Mix Groups** When this option is selected, soloing a track/channel that belongs to a group solos all other members of the group. When this option is deselected, tracks/channels must be soloed on an individual basis. When this option is selected, you can still solo/unsolo individual group members by Control-clicking (Macintosh) or Right-clicking (Windows) the solo button of the channel you want to affect individually.

**Smooth and Thin Data After Pass** When this option is selected, Pro Tools automatically smoothes and then applies the specified amount of thinning to the automation data created in an automation pass.

**Write Switches To Touch After Pass** (TDM Systems Only) After an automation pass in Auto Write mode, Pro Tools automatically switches to Auto Touch mode. On TDM systems, you can choose to stay in Auto Write mode by deselecting this option.

---

▲ Write Switches to Touch After Pass does not affect Trim Mode. In Trim Mode, channels do not automatically change from Trim/Auto Write to Trim/Auto Touch after an automation pass.

---

**Degree of Thinning** Specifies the amount of thinning performed on automation data when you use the Thin Automation command, or if you have selected the Smooth and Thin Data After Pass option in this dialog.

**Touch Timeout** If you are writing automation in Auto Touch mode and you stop moving a non-touch sensitive control, Pro Tools continues to write automation for the *Touch Timeout* period.

After the Touch Timeout period, writing of automation stops and the automation data returns to its previous automation value at the rate specified in the AutoMatch Time setting.

**AutoMatch Time** If you are writing automation in Auto Touch mode, when you release a fader or control, writing of automation stops and the automation data returns to its previous automation value. The rate of return to the previous value is the *AutoMatch Time*. See “About AutoMatch” on page 293.

## About Smoothing

When you perform automation moves with a continuous control, Pro Tools records the move as a series of very small steps, resulting in a staircase pattern with many breakpoints. Smoothing intelligently resolves this staircase pattern into a single, smooth ramp from one breakpoint to the next. (Smoothing does not apply to switched controls such as mutes or Plug-In bypasses.) With smoothing enabled, the resulting automation is often a more accurate representation of actual automation moves.



## About Thinning

Thinning automatically reduces the overall number of breakpoints in the automation playlist in order to improve system performance. The amount of thinning applied is determined by the Degree of Thinning setting in the Automation Preferences. When using high amounts of thinning, the resulting automation may differ noticeably from the original automation moves. Thinning only applies to audio tracks, and does not affect MIDI tracks. For more information, see “Thinning Automation” on page 299.

## About AutoMatch

When you write automation in Auto Touch Mode, if you release a fader during playback, Pro Tools returns to the level of any automation still on the track by ramping up or down over a certain amount of time, called the *AutoMatch Time*. This time value is set in the Automation Preferences.

The AutoMatch feature works with continuous controls (such as Volume or Pan) by ramping their values back to previously automated levels. There are some stepped controls (for example, the EQ type in the 1-band EQ Plug-In) that provide more than two discrete steps over their operational range. AutoMatch has no effect on these controls.

## AutoMatch Indicators

There are triangular AutoMatch indicators at the bottom left of each channel strip in the Mix window. These indicate the direction you need to move a fader in order to match the original automation level of that fader.



*Triangular AutoMatch Indicators on a channel strip*

---

## Viewing Automation

Pro Tools creates a separate Playlist for each type of automation you write. This data can be viewed and edited in the same way as audio and MIDI data.

### To show automation data:

- Click the Track Display Format selector for a track and choose the type of automation data to view from the pop-up menu.

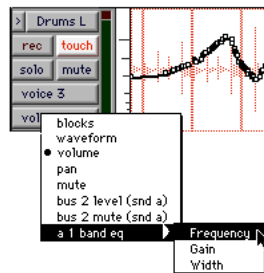

*Displaying automation data*

---

## Writing Automation

You can write automation for all automatable controls by moving those controls during playback.

### To write automation on a track:

- 1 In the Automation Enable window, make sure the automation type is write-enabled.
- 2 Choose an automation mode for each track you want to automate. For an initial automation pass, choose Auto Write.



*Choosing an automation mode*

- 3 Click Play to begin writing automation. Move the controls you want to automate.
- 4 When you have finished, click Stop.

After the first automation pass, you can write additional automation to the track without completely erasing the previous pass by choosing Auto Touch mode or Auto Latch mode. These modes add new automation only when you actually move the control for that parameter.

### To write additional automation to a previous pass:

- 1 In the Edit window, make a selection or place the cursor in a location where you want to write automation.
- 2 Choose Auto Touch or Auto Latch mode on the tracks you want to automate.
- 3 Click Play to begin writing automation. Move the controls you want to automate.
- 4 When you have finished, click Stop.

---

\* If you write automation in Auto Touch mode with Loop Playback enabled, writing of automation will automatically stop at the end of the looped selection. At the beginning of each successive loop, you can then touch or move the control again to write new data.

---

### Storing an Initial Controller Position

When you create a new audio track, Auxiliary Input, or MIDI track, it is automatically placed into Auto Read mode. Even though the track is in Auto Read mode, you can set the initial position of any automatable control, and it is saved with your session.

In this initial state, only a single automation breakpoint appears at the beginning of each automation playlist. If you move the control without writing automation, this breakpoint will move to the new value.

You can permanently store the initial position of an automatable control by doing one of the following:

- ◆ Place the track in Auto Write mode and press Play to write a few seconds of automation data to the track
- ◆ Manually place a breakpoint on the automation playlist somewhere after the initial breakpoint.

### **Automating Switched Controls**

Pro Tools treats switched controls (such as mutes and Plug-In bypasses) as touch sensitive controls. Automation data is written for as long as the switch or button for that control is pressed or touched.

For example, if you have just written a series of mute on/off states on a channel in quick succession, the manual method for clearing this automation data would require you to move to the Edit window, choose automation playlist for Mute, select the mute automation data, and delete it.

In Pro Tools, you don't have to perform all of these steps. Instead, you can perform another automation pass on the track and hold down the Mute button when it reaches the state you want to keep. As long as you hold down the button, Pro Tools overwrites the underlying mute data on the track with the current state of the switch until you press Stop.

## **Automating Sends**

Pro Tools allows dynamic automation of Send Level, Send Mute, and for stereo Sends, Send Pans. This feature makes it easy to control effects levels and stereo placement during mixdown with great precision.

### **To automate a Send Level, Mute or Pan:**

- 1** In the Automation Enable window, make sure the automation type is write-enabled.
- 2** Choose an automation mode for each track you want to automate. For an initial automation pass, choose Auto Write.
- 3** Select Windows > Mix Window Shows > Sends View.
- 4** Click the Send to open the Inserts/Sends Editor for the Send that you want to automate.

– or –

Choose Display > Sends View Shows and select the individual Send from the submenu.

- 5** Click Play to begin writing automation. Move the controls you want to automate.
- 6** When you have finished, click Stop.

### **Copying Track Automation to Sends**

#### **(TDM Systems Only)**

There may be times where you want a track's Send automation to mirror automation in the track itself, for example, when an effect level needs to follow the levels in a main mix. To do this, you can copy the entire automation playlist for the selected control to the corresponding playlist for the Send.

## To copy a track's automation to a Send on that track:

- 1 Select the tracks you want to edit by clicking on the track names to highlight them.
- 2 Choose Edit > Copy To Send.

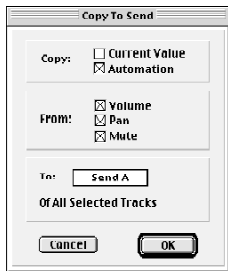

The Copy To Send dialog

- 3 In the Copy to Send dialog, select Automation to copy the entire automation playlist for the corresponding controls.
- 4 Choose the controls you want to copy.
- 5 Choose the Sends to copy the automation to, and click OK.

You can undo the results of this command by choosing Edit > Undo.

\* When overwriting automation, Pro Tools presents a confirmation dialog. To suppress this dialog, press Option (Macintosh) or Alt (Windows) while choosing the command.

## Automating Plug-Ins

You can create dynamic automation for virtually all parameters of the TDM Plug-Ins included with your Pro Tools system. Automating a Plug-In is slightly different from other automation procedures in that you must first enable automation parameters for the Plug-In.



Automation:  
in the In-  
e Plug-In.

### Accessing the Plug-In Automation dialog

- 2 Choose the parameters to automate and click Add. If there are multiple Plug-Ins on the same track, you can select from among these by clicking their buttons in the Inserts section of this dialog.

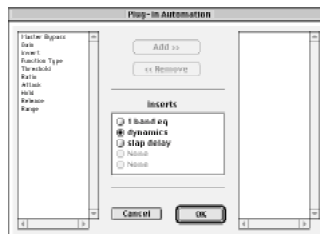

### Choosing which Plug-In parameters to automate

#### To automate a Plug-In:

- 1 In the Automation Enable window, make sure that Plug-In automation is enabled.
- 2 Choose an automation mode for each track you want to automate. For an initial automation pass, choose Auto Write.
- 3 Click OK to close the Plug-In Automation dialog.
- 4 Click Play to begin writing automation. Adjust the Plug-In parameters.
- 5 When you have finished, click Stop.

---

## Enabling or Suspending Automation

From the Automation Enable window, you can enable or suspend writing for the following automation parameters across all tracks:

- Volume
- Pan
- Mute
- Plug-In
- Send Level
- Send Pan
- Send Mute

### To suspend writing of automation on all tracks:

**1** Choose Windows > Show Automation Enable.

**2** Do one of the following:

- To suspend writing of all automation on all tracks, click the Auto Suspend button.
- To suspend writing of a specific type of automation on all tracks, click the button for that automation type (Volume, Mute, Pan, Plug-In, Send Level, Send Mute, or Send Pan).



Automation Enable window

## Suspending Automation Playback

You can suspend playback of automation parameters for tracks by clicking on the on the track's Display Format Selector.

### To suspend playback (and writing) of automation on individual tracks:

**1** In the Edit window, set the Track Display Format Selector pop-up to the automation parameter you want to suspend.

**2** Do one of the following:

- ◆ To suspend writing and playback of only the displayed automation parameter, Command-click (Macintosh) or Control-click (Windows) the parameter name in the Track Display Format Selector.
- ◆ To suspend writing and playback of all automation parameters, Command-Shift-click (Macintosh) or Control-Shift-click (Windows) the name of any automation parameter in the Track Display Format Selector.
- ◆ To suspend writing and playback of an automation parameter on all tracks, Command-Option-click (Macintosh) or Control-Alt-click (Windows) the name of the automation parameter in the Track Display Format Selector.

---

▲ Enabling and suspending automation from the Edit window obeys Edit Groups. This grouped behavior can be suppressed by Control-clicking (Macintosh) or Start-clicking (Windows) the parameter name.

---

## Automation Enable Guidelines

The following rules determine whether automation is written or played back for a track:

- ◆ Although Pro Tools shows a single automation mode for each track, all controls associated with that track are not necessarily in the same automation mode.
- ◆ If automation is globally suspended in the Automation Enable window, all controls behave as if they were in Auto Off mode, regardless of the track's current automation mode.
- ◆ If an automation parameter is suspended by Command-clicking (Macintosh) or Control-clicking its name in the Display Format Selector, that parameter behaves as if it were in Auto Off mode, regardless of the track's current automation mode.
- ◆ If an automation parameter is suspended in the Automation Enable window, that parameter behaves as if it is in Auto Read mode when the track is in a recordable automation mode (Auto Touch, Auto Latch, or Auto Write mode).

---

## Deleting Automation

Automation data takes the form of a line graph with editable breakpoints. The easiest way to remove automation in a track or selection is to manually delete breakpoints from the automation playlist.

Removing data in this manner is different from using the Cut command, which creates anchor breakpoints at the boundaries

of the remaining data. For details, see “Cutting, Copying, and Pasting Automation” on page 304.

To remove automation data, display the automation parameter you want to edit by selecting it from the Track Display Format Selector, and do one of the following:

### To remove a single breakpoint:

- With the Grabber or the Pencil Tool, Option-click (Macintosh) or Alt-click (Windows) the breakpoint.

### To remove several breakpoints at once:

- Use the Selector to select a range that contains the breakpoints, and press Delete (Macintosh) or Backspace (Windows).

### To remove all automation data of the displayed type:

- Click with the Selector in the track and choose Edit > Select All, then press Delete (Macintosh) or Backspace (Windows).

### To remove all automation for all automation playlists on a track:

- 1 Use the Selector to select a range of data to be removed.
- 2 Press Control+Delete (Macintosh) or Control+Backspace (Windows).

All automation data within the selection is removed for *all* automation playlists on that track, regardless of whether automation is write-enabled for those parameters.

---

## Thinning Automation

Pro Tools writes a maximum density of automation data during an automation pass, in the form of breakpoints. Since Pro Tools creates ramps between breakpoints, it may not need all of the captured points to create a sonically accurate representation of the automation moves that you have made. Each breakpoint takes up space in memory allocated for automation, so thinning data can allow you to maximize efficiency and CPU performance.

Pro Tools provides two different ways to thin automation data and remove unneeded breakpoints: the “Smooth and Thin Data After Pass” option and the Thin Automation command.

### Using the “Smooth and Thin Data After Pass” Option

When this option is selected in the Automation Preferences, Pro Tools automatically thins the automation breakpoint data after each automation pass.

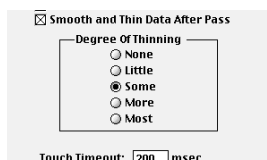

#### *The Smooth and Thin Data After Pass Option*

In the default settings for new sessions, the Smooth and Thin Data After Pass option is selected, with the “Some” setting chosen.

In most cases, this setting yields optimum performance while providing an accurate reproduction of your automation moves.

If you choose None, Pro Tools writes the maximum possible number of breakpoints. You can still perform thinning at any time with the Thin Automation command. For more information on smoothing automation data, see “About Smoothing” on page 292.

### Using the Thin Automation Command

The Thin Automation command allows you to selectively thin areas in a track where automation data is too dense. You can use the Undo command to audition the results of thinning before you apply it permanently.

#### **To use the Thin Automation command:**

- 1** In the Edit window, click a Track Display Format button to display the automation type you want to thin.
- 2** With the Selector, highlight the automation data you want to thin. To thin all automation of the selected type in the track, click the Selector in the track and choose the Select All command.
- 3** Choose Edit > Thin Automation to thin the selected automation by the amount you have selected in the Automation Preferences.

---

## Drawing Automation

You can use the Pencil tool to create automation events for audio and MIDI tracks by drawing them directly in any automation or MIDI controller playlist.

The Pencil tool can be set to draw a series of automation events with the following shapes:

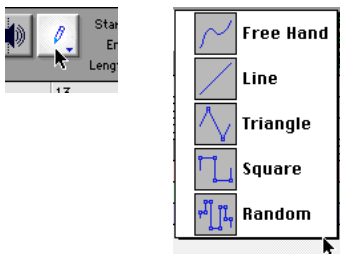

*Choosing a Pencil Tool Shape*

**Free Hand** Draws any shape. In audio tracks, the shape has the number of breakpoints needed to smoothly interpolate and reproduce the automation shape. In MIDI tracks, the shape is reproduced as a series of steps, according to the resolution setting in the MIDI preferences.

**Line** Draws a straight line. In audio tracks, the line has a single breakpoint at either end. In MIDI tracks, the controller value changes in steps according to the resolution setting in the MIDI preferences.

**Triangle** Draws a sawtooth pattern that repeats at a rate based on the current Grid value. In audio tracks, the pattern has a single breakpoint at each extreme. In MIDI tracks, the controller value changes in steps according to the resolution setting in the MIDI preferences. Amplitude is controlled by vertical movement of the Pencil tool.

**Square** Draws a square pattern that repeats at a rate based on the current Grid value. Amplitude is controlled by vertical movement of the Pencil tool.

**Random** Draws a random pattern of levels that change at a rate based on the current Grid value. Amplitude is controlled by vertical movement of the Pencil tool.

### Using Pencil Tool Shapes

You can draw automation for audio as well as MIDI tracks. For example, you can use the Triangle pattern to control continuous functions, or the Square pattern to control a switched function such as Mute or Bypass.

Since the pencil draws these shapes using the current Grid value, you can use it to perform panning in tempo with a music track, or on-frame scene changes when working in post-production.

### Resolution of MIDI Controller Data

When using the Pencil tool to draw MIDI automation, the data is drawn as a series of discrete steps. You can control the density of these steps to help manage the amount of MIDI data sent for a given MIDI controller move.

#### To set the resolution for the Pencil tool:

- 1 Choose **Setups > Preferences** and click **MIDI**.
- 2 Enter a value for “Pencil Tool Resolution When Drawing Controller Data.” The value can range from 1 to 100 milliseconds.



The illustrations below show the same MIDI controller automation drawn with different Pencil Tools resolution settings.

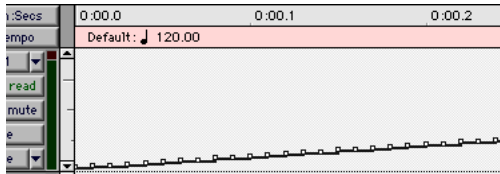

*MIDI Data drawn with resolution of 10 ms*

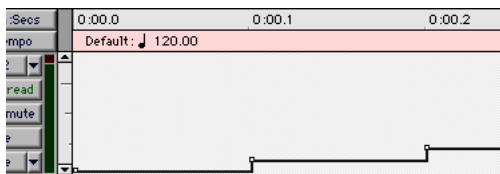

*MIDI Data drawn with resolution of 100 ms*

You may want to choose a smaller value for MIDI controls that need higher resolution (such as MIDI Volume), and a larger value for controls that may not require such a high resolution (such as Pan).

## Editing Automation

Pro Tools provides several ways to edit automation data for any track in your session. You can edit automation data graphically, by adjusting breakpoints on the automation playlist of a track. You can also cut, copy, and paste automation data in the same manner as audio and MIDI data.

## Graphical Editing of Automation Data

Automation data takes the form of a line graph with editable breakpoints. By dragging these breakpoints, you can modify the automation data directly in the Edit window. When you drag an automation breakpoint up or down, the change in value is numerically or textually indicated. Dragging an automation breakpoint to the left or right adjusts the timing of the automation event.

### Using the Grabber

The Grabber allows you to create new breakpoints by clicking on the graph line, or adjust existing breakpoints by dragging them. Option-click (Macintosh) or Alt-click (Windows) breakpoints with the Grabber to remove them.

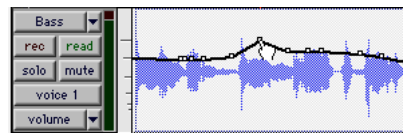

*Using the Grabber to create a new breakpoint*

### Using the Pencil Tool

The Pencil tool allows you to create new breakpoints by clicking once on the graph line. Option-click (Macintosh) or Alt-click (Windows) breakpoints with the Pencil tool to remove them.

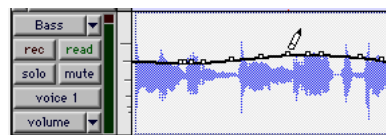

*Using the Pencil to delete a breakpoint*

## Using the Trimmer

The Trimmer allows you to adjust all selected breakpoints up or down by dragging anywhere within that selection.

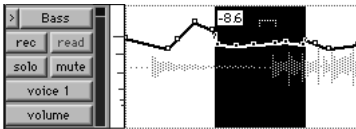

Using the Trimmer to move breakpoints

## Editing Automation Types

Each automatable control has its own automation playlist, which can be displayed by choosing it from the Track Display Format Selector. See “Viewing Automation” on page 293.

### Editing Volume Automation

Drag a Volume automation breakpoint up or down to change the dB value. Drag a breakpoint to the left or right to adjust the timing of the volume change.

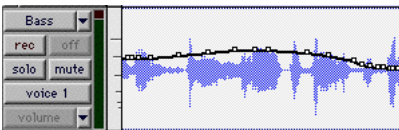

Track Volume automation

### Editing Pan Automation

Drag a breakpoint down to pan right, and up to pan left. Drag a breakpoint to the left or right to adjust the timing of the panning moves.

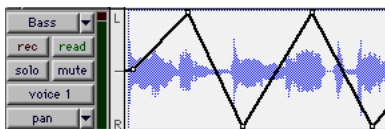

Track Pan automation

## Editing Mute Automation

Drag the breakpoint down to mute a section. Drag a breakpoint up to unmute the section. Drag a breakpoint to the left or right to adjust the timing of the mute.

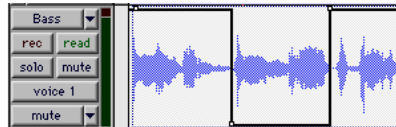

Track mute automation

## Editing Stepped Control Automation

Automation for certain controls, such as MIDI controllers values or Plug-In settings, appears as a stepped pattern on the breakpoint line. Drag a breakpoint up or down to a different step to change to a new control value. Drag a breakpoint to the left or right to adjust the timing of the stepped control change.

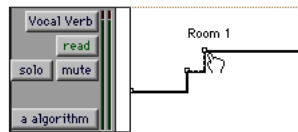

Stepped control automation

## Editing Automation Breakpoints

To edit automation breakpoints, display the automation parameter you want to edit by selecting it from the Track Display Format selector, then do one of the following:

### To create a new breakpoint:

- Click with the Grabber (or the Pencil) on the line graph.

### To edit a breakpoint:

- Click an existing point on the line graph with the Grabber and drag it to a new position.

### To edit several breakpoints at once:

- Use the Selector to select a range in the automation playlist that contains the breakpoints, and do one of the following:

- ◆ To move the breakpoints earlier or later in the track, press the Plus key (+) to nudge them later (to the right) or the Minus key (–) to move them earlier (to the left). The breakpoints move by the current Nudge value.

- ◆ To adjust the breakpoint values, click with the Trimmer in the selection and drag the breakpoints up or down.

---

\* When you use the Trimmer to edit a selection containing breakpoints, new anchor breakpoints are created before and after the selected area. To suppress creation of anchor breakpoints, press Option (Macintosh) or Alt (Windows) while using the Trimmer.

---

### To edit all breakpoint values in a region:

- Click in the region with the Trimmer and drag the breakpoints up or down.

## Editing Automation on Grouped Tracks

When you edit automation on a track that is a member of an active Edit Group, the same type of automation (with the exception of audio and MIDI Pan controls) is also edited on all tracks that are part of that group. This occurs even if that parameter is not currently displayed on the other grouped tracks.

- ◆ If you create new automation breakpoints on a grouped track (with the Grabber or Pencil), other members of the group have breakpoints placed relative to that track.

- ◆ If you move Volume or Send automation on a grouped track (with the Trimmer), other members of the group have their Volume or Send breakpoints trimmed relative to that track. This allows you to trim entire sections of a mix.

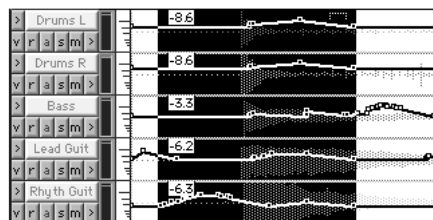

*Trimming automation on an active grouped track*

To individually edit a member of a group without affecting the other members, do one of the following:

- ◆ Disable the group by deselecting its name in the Groups List.
- ◆ Choose Suspend All Groups from the Groups List pop-up menu.
- ◆ Press Control (Macintosh) or the Start key (Windows) while you perform the edit.

---

▲ When editing automation, audio and MIDI Pan controls work opposite from the way all other controls work. When you edit or trim Pan breakpoints, Edit Groups are not obeyed. For grouped Pan behavior, press Control (Macintosh) or the Start key (Windows) while trimming.

---

## Cutting, Copying, and Pasting Automation

*Cutting* automation data is different from *deleting* it, and yields different results. *Copying* automation leaves the original automation data intact.

You *delete* automation data by selecting a range of breakpoints and pressing Delete (Macintosh) or Backspace (Windows). See “Deleting Automation” on page 298 for details.

You *cut* automation data by selecting a range of breakpoints from an automation playlist and selecting the Cut command.

When you cut automation data and when you paste it into a new location, anchor breakpoints are added to the beginning and end points of the data. This is done to preserve the true slope (of continuous controls, such as Volume faders or pans) or state (of switched or stepped controls, such as Mutes) of the automation data both inside and outside the selection.

The following illustrations show the difference between cutting and deleting automation data. In Figure 19, a track is set to display Volume automation, and a range of automation data is selected.

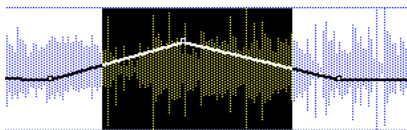

Figure 19. Selecting automation data

If the Cut command is chosen, anchor breakpoints are created at each end of the selection, and the automation slope on either side of the cut data is preserved, as shown in Figure 20.

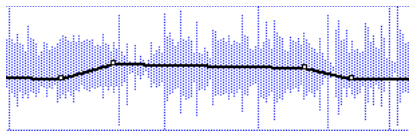

Figure 20. After cutting the automation data

If the data is deleted by pressing Delete (Macintosh) or Backspace (Windows), the automation data is removed, and automation values span the gap between pre-existing breakpoints, as in Figure 21.

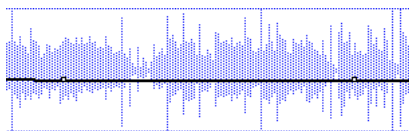

Figure 21. After deleting the automation data

In addition, if cut or copied data is pasted elsewhere in a track, breakpoints are created at the end points of the pasted data to preserve its value and slope, as shown in Figure 22.

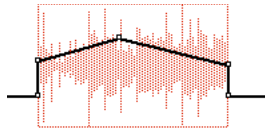

Figure 22. After pasting the automation data in another location

## Editing and Track Display Formats

Audio and MIDI tracks each have a Track Display Format that acts as the main format for purposes of editing. When the main format is displayed, any edits performed on the track apply to all data in the track.

The main display formats are:

- Audio Tracks: Waveform and Blocks
- MIDI Tracks: Regions, Blocks, and Notes

For example, when an audio track is set to Waveform or Blocks, cutting, copying and pasting affects the audio data and all types of automation data on that track. If the track is set to show Pan automation, only the Pan data is affected.

When a selection includes multiple tracks, if any of those tracks is in its main display format, *all* data on all selected tracks is affected.

To edit all automation types on an Auxiliary Input or Master Fader track, do one of the following:

- ◆ Make an edit selection that includes at least one audio or MIDI track that is displayed in its main format.
- ◆ Press Control while cutting or copying the automation data.

## Tips for Cutting, Copying and Pasting

- ◆ On audio tracks, when you are in waveform view and cut or copy a section of the waveform, any automation data associated with the waveform is also cut or copied.
- ◆ On audio tracks, when you are in waveform view and cut audio data from a track also containing automation data, breakpoints are automatically created at the boundaries of the remaining automation data.
- ◆ On audio tracks, pasting waveform data also pastes any associated automation data.
- ◆ On Auxiliary Input or Master Fader tracks, only the displayed automation data is cut or copied. To cut or copy all automation data on these types of tracks, press Control while cutting or copying.
- ◆ In tracks where an automation playlist contains no data (when there is only a single breakpoint at the very beginning of the track), if you cut data, no new breakpoints are created.
- ◆ In cases where regions overlap (such as when moving regions in Slip mode) and an overlapping region is removed, any overlapped automation breakpoints are lost.
- ◆ If cut or copied data contains a type of automation not currently on the target track, Pro Tools prompts you before allowing you to paste the data.
- ◆ Cut or copied automation data for Plug-Ins or Sends that do not exist on the target track is ignored when pasted.

## Special Paste Function for Automation Data

Normally, when you copy and paste automation data, it is pasted in an automation playlist of the exact same type (for example, Left Pan data is pasted into the Left Pan playlist).

However, there may be times when you want to paste from one data type to another (for example, pasting Send 1 level data into the Send 2 level playlist, or track Mute data into the Send Mute playlist).

### To paste data into a different automation playlist:

- Press Control (Macintosh) or the Start key (Windows) when choosing Edit > Paste.

For this special paste mode to function, the following must be true:

- ◆ Every track selected for pasting must be currently displayed as automation data.
- ◆ There must be only one automation playlist on the Clipboard for each target track. (The Special Paste function cannot copy multiple automation playlists for each track.)

- ▲ You cannot interchange automation data between audio and MIDI tracks, or between continuous controls (such as faders or pans) and switched or stepped controls (such as or mute or MIDI controllers).

## Writing Automation to the Start, End or All of a Selection

### (TDM Systems Only)

Pro Tools allows you to write current automation values from any insertion point forward (or backward) to the end (or beginning) of a selection or track, or to an entire selection or track, while performing an automation pass.

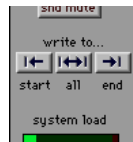

The Write to Start/All/End buttons in the Automation Enable window

The Write to Start/All/End command does not operate when the Pro Tools transport is stopped. It only affects those automation parameters that are currently write-enabled and currently writing automation data. For an automation parameter to write automation data, the associated track must be in one of the following automation modes and meet the following conditions:

**Latch mode** The automation parameter must be changed (touched) during the automation pass.

**Touch mode** The automation parameter must be changed (touched).

**Write mode** All automation parameters on that track must be in Auto Write mode.

This command can be undone by choosing Edit > Undo.

**To write current automation values to the beginning/end/all of a track or selection:**

- 1 In the Automation Enable window, make sure that the automation type is write-enabled.
- 2 Click in a track at an insertion point.  
– or –

Drag with the Selector to select a portion of the track.

- 3 Click Play to begin playback.
- 4 When you reach a point in the track/selection that contains the automation data, click Write to Start, Write to All, or Write to End in the Automation Enable window.

The current values of all write-enabled automation at that point are written to the corresponding area of the track/selection.

### Trim Mode

Using Trim mode, it is also possible to write trim delta values for track Volume and Send Levels to the beginning, end or all of a track.

**To write current trim delta values to the beginning/end/all of a track or selection:**

- 1 In the Automation Enable window, make sure that the automation type (track Volume or Send Level) is write-enabled.
- 2 Click the Automation Mode selector on the track. Select Trim from the pop-up menu to enable Trim mode. The track Volume and Send Level faders turn yellow.
- 3 Click in a track at an insertion point.  
– or –

Drag with the Selector to select a portion of the track.

- 4 Click Play to begin playback.
- 5 When you reach a point in the track/selection that contains the trim setting (delta value) you want to apply, click the Write to Start, Write to All, or Write to End button in the Automation Enable window.

The relative changes to the track Volume and Send Levels at that point are written to the corresponding area of the track/selection.

---

## Trimming Automation

### (TDM Systems Only)

If you have already written automation, you can modify automation data for track Volume and Send Levels in real time by using Trim mode. When a track is trim-enabled, you are not recording absolute fader positions, but relative changes in the existing automation. See “Trim Mode” on page 289 for more information.

#### To enable Trim mode:

- Click the Automation Mode selector and choose Trim from the pop-up menu.

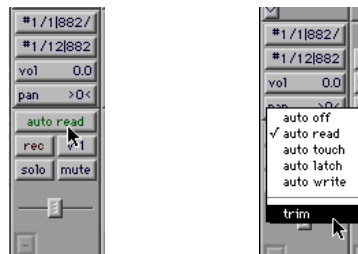

Enabling Trim mode

When trim mode is enabled for a track, its Volume and Send Level faders turn yellow, and its automation mode button is out-

lined in yellow. This outline flashes to indicate that the track is trim-enabled, and appears solid whenever trimming is occurring on the track's Volume or Send Levels.

### **To trim Track Volume or Send Levels in real time:**

- 1** In the Automation Enable window, make sure the automation type (Volume or Send Level) is write-enabled.
- 2** Click the Automation Mode selector on the tracks you want to automate and select Trim from the pop-up menu.
- 3** Click the Automation Mode selector a second time and choose an automation mode:
  - ◆ Use Auto Touch or Auto Latch to have the faders follow existing automation, so you can “chase” them during the automation pass.
  - ◆ Use Auto Write if you want to disengage the faders from existing automation.
- 4** Click Play to begin trimming automation, and move the Volume or Send Level faders.
- 5** When you have finished, click Stop.

---

## **Creating Snapshot Automation**

### **(TDM Systems Only)**

Pro Tools lets you write automation data values for multiple parameters in a single step. You can write snapshot automation in two ways:

**To a selection** Automation data is written to the selected area. Anchor breakpoints are placed just before and after the selection so that data outside the selection is not affected.

**To a cursor location** Automation data is written at the insertion point. After the insertion point, the automation ramps to the next breakpoint value, or if no breakpoints exist, remains at the newly written value for the remainder of the session.

For more information on copying automation data within a session, see “Writing Automation to the Start, End or All of a Selection” on page 306.

### **To write snapshot automation:**

- 1** In the Edit window, click the Track Display Format button to show the automation you want to edit.
- 2** In the Automation Enable window, make sure that the automation parameters you want to edit are write-enabled. Disable any parameters you want to preserve.
- 3** With the Selector, select the area where you want to apply the automation.
  - or –

Place the cursor at an insertion point.

- 4** Adjust the controls for the parameters you want to automate.
- 5** Choose Edit > Write Automation and do one of the following:
  - ◆ To write the current value to only the currently displayed automation parameter, choose To Current Parameter.
  - ◆ To write the current settings for all automation parameters enabled in the Automation Enable window, choose To All Enabled Parameters.



## **Adding Snapshot Automation to Empty Automation Playlists**

When you use the Write Automation command on an automation playlist with no previously written automation data, the selected value is written to the entire playlist and not just the selected area.

This is because a playlist with no automation data contains only a single automation breakpoint that corresponds to the current position of the control. The position of the breakpoint is updated whenever the parameter value is changed.

If you do not want the Write Automation command to write the selected automation value to the entire playlist, you can:

- ◆ Anchor the automation data by placing the cursor at the end of the session (or any other endpoint) and choosing Write Automation To Current Parameter.
  - or –
- ◆ Click with the Grabber on each side of the selection.

This allows the Write Automation command to write only to the selected area.

## **Writing Snapshot Automation over Existing Automation Data**

When you move the playback cursor, the automated controls in Pro Tools update on the screen to reflect the automation data that is already on the track. To keep the settings you have made for a snapshot, you can suspend the desired automation parameters to prevent the controls from updating.

### **To write snapshot automation over existing data:**

- 1** In the Automation Enable window, make sure that the automation parameters you want to edit are write-enabled. Disable any parameters you want to preserve.
- 2** Adjust the controls for the parameters you want to automate.
- 3** Suspend the automation parameters you want to automate:
  - For an automation parameter on a single track, Command-click (Macintosh) or Control-click (Windows) the name of the automation type in the track's Display Format Selector.
  - For an automation parameter on all tracks, Command-Shift-click (Macintosh) or Control-Alt-click (Windows) the name of the automation type in the Display Format Selector for any track.
  - To suspend all automation on a track, Command-Shift-click (Macintosh) or Control-Shift-click (Windows) the name of the automation type in the track's Display Format Selector.
- 4** With the Selector, select the location where you want to apply the automation.
- 5** Enable the automation parameters previously suspended.
- 6** Choose Edit > Write Automation and select one of the following from the submenu:
  - To write the current value to only the automation parameter currently displayed in the Edit window, choose To Current Parameter.
  - To write the current settings for all automation parameters enabled in the Automation Enable window, choose To All Enabled Parameters.

## Capturing Automation and Applying it Elsewhere

The Write Automation command can also be used to capture automation states at specific locations in a session and apply them to other locations. This differs from simply copying and pasting automation data in that you can set any selection length for the application of the captured automation data.

### To capture and apply automation:

- 1 In the Automation Enable window, make sure that the automation parameters you want to edit are write-enabled. Disable any parameters you want to preserve.
- 2 Click the Selector at the location with the automation you want to capture. All automated controls update to reflect the automation at that location. (If you make a selection, the controls update to reflect the automation at the beginning of the selection.)
- 3 Suspend the automation parameters you want to automate:
  - For an automation parameter on a single track, Command-click (Macintosh) or Control-click (Windows) the name of the automation type in the track's Display Format Selector.
  - For an automation parameter on all tracks, Command-Shift-click (Macintosh) or Control-Alt-click (Windows) the name of the automation type in the Display Format Selector for any track.
  - To suspend all automation on a track, Command-Shift-click (Macintosh) or Control-Shift-click (Windows) the name of the automation type in the track's Display Format Selector.

4 With the Selector, select the location where you want to apply the automation.

5 Enable the automation parameters previously suspended.

6 Choose Edit > Write Automation and select one of the following from the submenu:

- To write the current value to only the automation parameter currently displayed in the Edit window, choose To Current Parameter.
- To write the current settings for all automation parameters enabled in the Automation Enable window, choose To All Enabled Parameters.

## Snapshot Automation and Trimming of Automation Data

Pro Tools allows you to use trim values as snapshots and apply the *relative* changes (delta values) to the selected automation by using the Trim Automation command. This works in much the same way as the Write Automation, except that it writes delta values instead of absolute values to automation data.

You can use trim values in writing snapshot automation to any automatable parameter.

### To create a snapshot of relative changes in automation data:

- 1 In the Automation Enable window, make sure that the automation parameters you want to edit are write-enabled. Disable any parameters you want to preserve.

2 Select the area of the track you want to edit. All automated controls update to reflect the automation at the beginning of the selection.

3 Move the controls for the parameter up or down by the amount you want to change the data.

4 Choose Edit > Trim Automation and do one of the following:

- ◆ To write the current delta value to only the currently displayed automation parameter, choose To Current Parameter.
- ◆ To write the current delta value for all automation parameters enabled in the Automation Enable window, choose To All Enabled Parameters.

---

## Setting the Automation Buffer Size

Pro Tools allows you to specify the size of the memory buffer used to write automation. If you are working on a large session or writing a very large number of automation moves, you may want to increase this value.

### To set the Automation Buffer size:

- 1 Choose Setups > Preferences and click Automation.
- 2 For the option “Amount of memory to reserve for automation recording,” enter a value between 200 and 3000K for this option (the default value for a new session is 200K.)
- 3 Relaunch Pro Tools for this change to take effect.

## About Processing Bandwidth

Meters in the Automation Enable window indicate how much of your system’s processing power is being used in processing audio, and when writing and playing back automation. On Pro Tools LE-based systems, these meters show System Load and CPU processing capacity; on Pro Tools TDM systems, they show System Load and PCI bus traffic.

As these meters approach their limits, recording or playback of automation data may be affected. If CPU Load or PCI Load are high, a System error may occur. If System Load is high, Pro Tools may miss playback of some of your automation data during particularly dense periods of activity.

In both cases, to reduce processing load, you can first try deselecting the Moving Faders During Playback option in the Automation Preferences.

You can also reduce the density of automation in places where it shows the most activity. For details, see “Thinning Automation” on page 299.

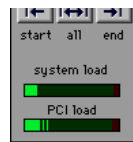

*Load Meters in the Automation Enable Window*



# Mixdown and Mastering

Pro Tools lets you re-record or *bounce* tracks to disk, for purposes of creating a submix or a final mixdown. You can master your final mix directly to disk or use an external mastering recorder.

---

## Bouncing Tracks to Disk

The Bounce to Disk command lets you mix down with all available voices on your system. Since it records to separate audio files, you don't have to reserve any tracks for a bounce.

You can use the Bounce to Disk command to create a submix and automatically import the bounced tracks into your session. You can also use it to create a final mono or stereo mix in any of several audio file formats.

When you bounce a track to disk, the bounced mix will include the following:

**Audible tracks** All audible tracks are included in the bounce. Any muted tracks do not appear in the bounce. If you solo a track or region, only the soloed elements appear in the bounced mix.

**Automation** All read-enabled automation is played back and incorporated in the bounced mix.

**Inserts and sends** All active inserts, including real-time Plug-Ins and hardware inserts, are applied to the bounced mix.

**Selection or track length** If you make a selection in a track, the bounced mix will be the length of the selection. If there is no selection in any track, the bounce will be the length of the longest audible track in the session.

**Time stamp information** Bounced material is automatically time stamped so that you can drag it into a track and place it at the same location as the original material. For more information about time stamping, see "Time Stamping" on page 361.

Pro Tools bounces are done in real time, so you hear audio playback of your mix during the bounce process.

---

## Bounce Parameters

When you use the Bounce to Disk command, you can set several parameters that affect the bounced audio.

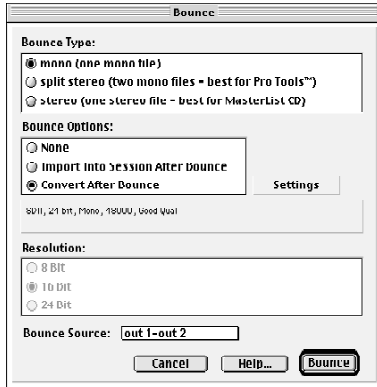

*Bounce dialog*

### Bounce Type

This parameter allows you to select between three audio file types:

**Mono file** Creates a single audio file. A composite monophonic mix of all audible tracks in the session is written to this file. All stereo image information (panning) is disregarded.

**Split Stereo file** Creates two mono audio files with “.L” and “.R” appended to the filename (for left and right, respectively). This file type lets you use bounced material in your Pro Tools session.

In a split stereo bounce, tracks assigned to odd-numbered outputs are sent to the left channel, and tracks assigned to even-numbered outputs are sent to the right channel.

**Stereo file** Creates a single interleaved stereo file. This allows you to use the file in applications that support an interleaved stereo file format. In an interleaved stereo bounce, tracks assigned to odd-numbered outputs are sent to the left channel, and tracks assigned to even-numbered outputs are sent to the right channel.

---

▲ Pro Tools cannot work with stereo interleaved files without first converting them into split stereo files. If you plan to use bounced tracks in Pro Tools, choose Split Stereo files.

---

### Import Into Session After Bounce

The Import Into Session After Bounce option automatically imports the newly bounced files into the Audio Regions List so you can place them in tracks. If your newly bounced files are split stereo files, they are listed together in the Audio Regions List.

---

\* The Import Into Session After Bounce option is only available if the target bit depth for the bounce is the same as the bit depth of the current session.

---

### Convert After Bounce

The Convert After Bounce option automatically performs file type, sample rate and bit resolution conversion on the newly bounced files, based on the settings in the Output Options dialog.

## Resolution

This parameter allows you to select between three different bit resolutions for the bounced file:

**8-bit** This resolution is often used in multimedia applications. If the material you are working with is relatively simple, you can use the Pro Tools “Squeezer” feature for optimal results. See “Use Squeezer” on page 320 for details.

**16-bit** This is the Compact Disc standard bit resolution.

**24-bit** If you plan to use the bounced file with a Pro Tools 24 MIX or Pro Tools 24 system, you can take advantage of the greater resolution and headroom afforded by this higher bit rate. You can also archive a master stereo mixdown or bounce audio material at this resolution for future use on a 24-bit system.

## Bounce Source

This parameter allows you to select the output pair or bus pair that carries the audio you want to bounce. Before you perform a bounce, make sure that all of the tracks you want to include in the bounce are routed to the pair that you choose here.

## Output Options

If you select Convert After Bounce, you can then click Settings to set Pro Tools output options.

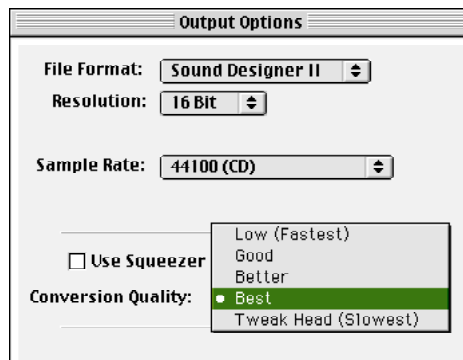

*Bounce Output Options*

## File Format

### Sound Designer II

This is the native format for Macintosh-based Pro Tools systems. Select this to use the bounced audio with any Digidesign application for Macintosh.

### AIFF (Audio Interchange File Format)

Files in this format do not have to be converted to be used in Pro Tools, but you must still import them into a session with the Import Audio command or the Convert and Import Audio command. AIFF waveform overview data cannot be stored in the file, so the overview is recalculated every time the session is opened. The AIFF format is useful if you plan to use bounced audio in applications that do not support the Sound Designer II format.

## WAV (Windows Audio File Format)

This is the native format for Windows-based Pro Tools systems. The WAV format is supported by many Windows applications and some Macintosh applications. To use a WAV file on Macintosh-based Pro Tools systems, you must use the Convert and Import Audio command.

## SND resource (Macintosh Only)

This file type is supported by some Macintosh software applications and also by Macintosh System Software. Pro Tools does not directly support this type of file in its sessions. To use a SND file within Pro Tools, use the Convert and Import Audio command. The SND format is useful if you plan to use your audio with other Macintosh applications that do not support Sound Designer II or AIFF formats. To save a bounced file as a System alert sound, save it in this format and then drag it onto the Macintosh System File.

## QuickTime (Macintosh Only)

This is Apple's audio file format for QuickTime-based multimedia. Pro Tools does not directly support this type of file in its sessions. To use a QuickTime audio file within Pro Tools, use the Convert and Import Audio command or Import Audio from Other Movie command. The QuickTime format is best if you plan to use your audio in multimedia applications that support QuickTime, such as Adobe Premiere™ or Macromedia Director™.

## RealAudio G2 (Macintosh Only)

RealAudio G2 is the latest version of the format created by Real Networks for streaming audio over the Internet. The RealAudio encoder file is stored in a folder named Codecs inside the DAE folder.

When you select this format, the Resolution and Sample Rate pop-up menus in the Pro Tools Output Options dialog are unavailable, because resolution and sample rate are set by the encoder.

The RealAudio G2 format allows multiple streams with different bit rates to be encoded into a single file. During playback, the RealAudio G2 server and the RealPlayer G2 client continuously adjust the bit rate to make the best use of available bandwidth. The RealPlayer G2 is available on the Real Networks website, [www.real.com](http://www.real.com).

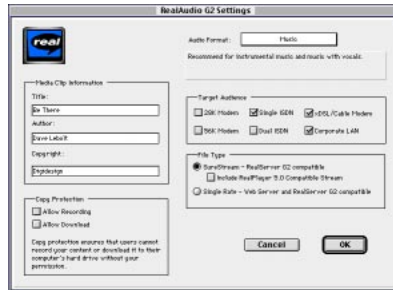

### RealAudio G2 Output Options

When you export or bounce to RealAudio G2 format, you can set the following options:

**Media Clip Information** Type the title, author, and copyright information for your RealAudio clip. This information is displayed on the RealPlayer G2 as the clip plays back.



**Copy Protection** These settings determine how the clip is handled by the RealPlayer client.

- To allow RealPlayer Plus users to save your clip using the RealPlayer Plus recording feature, select Allow Recording.
- To allow RealPlayer users to download your clip to their hard drive, select Allow Download.

If you don't want to allow RealPlayer users to make copies your clip, deselect both of these options.

**Audio Format** From the pop-up menu, select the setting that best matches the type of audio you are bouncing. A brief explanation of each format is displayed.

**Target Audience** Select the connection speed that most users downloading your clip are likely to have. This setting determines the bit rate at which the audio will be encoded. Depending on the file type you choose (see below), you can choose more than one connection speed.

**File Type** This option determines the compatibility of the output file with different RealAudio servers and clients.

If you select SureStream, you can select more than one connection speed under Target Audience. With this file type, multiple bit rate streams are encoded into a single output file. Files encoded with the SureStream option are larger than Single Rate files, and can only be played back from G2 servers.

Select the "Include RealPlayer 5.0 Compatible Stream" option to include a backward compatible stream that can be played on

older version 5.0 RealPlayers. (This backward compatibility is only available for SureStream-encoded files.)

If you select Single Rate, you can only select one connection speed under Target Audience. With this file type, a single stream is encoded into the output file. Files encoded with the Single Rate option can be played back from either a standard web server or a G2 server.

### **Auditioning RealAudio clips**

If you are using Digidesign Sound Drivers and want to use a RealAudio player while running Pro Tools, make sure that Operations > Active in Background is not selected so the player can use the Digidesign hardware.

### **MP3**

The MPEG Layer 3 compression format (MP3) is used for streaming and downloading audio over the Internet, and for playback on portable devices.

The MP3 encoder file is stored in a folder named Codecs inside the DAE folder. This version of the encoder uses the latest technology from the developer of the MP3 format, the Fraunhofer Institute. It features improved processing speed and quality, and supports both constant and variable bit rate encoding.

The MP3 encoder installed with Pro Tools is a fully functional 30-day demo version. To purchase the full version of the MP3 encoder, visit Digidesign's website.

When you select this format, the Resolution and Sample Rate pop-up menus in the Pro Tools Output Options dialog are unavailable, because resolution and sample rate are set by the encoder.

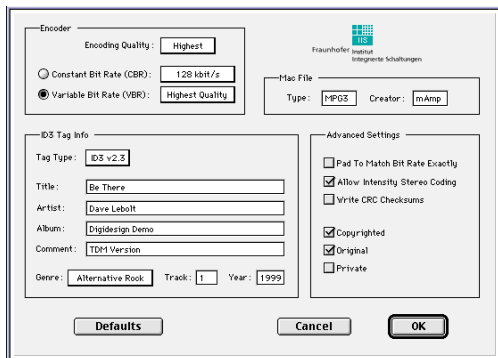

### MP3 Output Options

When you export or bounce to MP3 format, you can set the following options:

**Encoding Quality** Determines the audio quality of the bounced file. The higher the quality, the longer it will take to process the audio. The three options, in ascending order of quality, are Fastest Encoding, Medium Encoding, and Highest Quality.

The Highest Quality setting can take up to five times longer to process audio than the Fastest Encoding setting, so you should use it only when the highest fidelity is essential and you have a considerable amount of time to devote to the encoding process. You should experiment with the other encoding quality settings, since they can provide acceptable quality with a significantly shorter encoding time.

**Encoding Method** Two encoding methods are available:

- ◆ **Constant Bit Rate (CBR)** encodes the file at a single bit rate that you choose from the CBR pop-up menu. Because the bit rate is fixed, the quality of the encoded audio will vary depending on the nature of the material being compressed. This option is best for streaming over the Internet, since it has predictable bandwidth requirements.

- ◆ **Variable Bit Rate (VBR)** encodes the file at a varying bit rate to maintain the level of encoding quality you choose from the VBR pop-up menu. The bit rate varies automatically depending on the nature of the material being compressed. This option is best for personal jukebox applications.

**ID3 Tag Type** The ID3 tag stores data about the encoded audio file that is used by MP3 players to display information about the file. Pro Tools supports three versions of this tag, in order to provide backward compatibility with older MP3 players:

- ◆ **ID3 v1.0:** Appears at the end of a streaming MP3 file, so tag information is only displayed when streaming is finished.
- ◆ **ID3 v1.1:** Same as version 1.0 but adds track number information to the tag.
- ◆ **ID3 v2.3:** Appears at the front of a streaming MP3 file, so tag information is displayed when streaming begins.

---

▲ While ID3 v2.3 is becoming the standard MP3 format, not all MP3 players currently support ID3 v2.3. Contact the developer of your player software for compatibility information.

---

**ID3 Tag Information** Type the title, artist, and other information for the MP3 file. This information is displayed by many MP3 players.

**Genre** Choose a genre for the file. This information is displayed by many MP3 players, and can appear in searchable catalogs and databases.

**Track Number** If you select ID3 tag type v1.1 or v2.3, you can enter a CD track number for the file. This information is displayed by many MP3 players.

**Year** Enter a year for the file. This information is displayed by many MP3 players.

### Advanced Settings

The options listed under Advanced Settings, under normal situations, do not need to be changed from their default values.

**Pad To Match Bit Rate Exactly** This option determines whether MP3 frames are padded to maintain bit rate very precisely. You should only select this option if you need a file with an exact bit rate, for applications like synchronous transmission over an ISDN line.

---

▲ Padding of MP3 frames can cause problems with some versions of Internet streaming software. If your files are destined for desktop or Internet delivery, do not select this option.

---

**Allow Intensity Stereo Coding** This option determines whether the encoder takes into account the frequency of a signal when encoding its phase characteristics, allowing for more compression at low bit rates. In most cases, you should leave this option selected. However, if you are working with highly phase-dependent material, such as Dolby Surround, you may want to deselect this option.

**Write CRC Checksums** This option adds error-detection data to the MP3 file, which isn't necessary for most computer and Internet applications, and also takes away from the space available for audio data. Select this option only if you are sure your delivery mode requires error correction.

**Copyrighted** This option sets a bit in the MP3 data stream to indicate that the audio is copyrighted. Not all MP3 players use this information. Selecting this option does not guarantee that the audio file will not be copied.

**Original** This option sets a bit in the MP3 data stream to indicate that the audio is the original media for the track, rather than a copy. This setting is not widely used.

**Private** This option sets a bit in the MP3 data stream that is interpreted differently by various applications. It is not normally used.

**Mac File information** If you expect your file to be used on a Macintosh, you can enter the Macintosh file type and creator. This will allow users to double-click the file to open their MP3 player.

**Defaults** To restore all settings in this dialog to their default values, click Defaults.

### Auditioning MP3 clips

If you are using Digidesign Sound Drivers and want to use an MP3 player to audition an MP3 file while running Pro Tools, make sure that Operations > Active in Background is not selected so your MP3 player can use the Digidesign hardware.

## Resolution

This option in the Pro Tools Output Options dialog sets a bit resolution for the converted audio file. See “Resolution” on page 315 for explanations of each resolution setting.

## Channels

This option appears in the Pro Tools Output Options dialog only when you are exporting selected audio as files, not when you are bouncing to disk.

**Mono** Saves all selected regions as individual files.

**Stereo from .L/.R** Saves all matching region pairs from a selection as stereo interleaved files. Regions that don’t have matching .L/.R named pairs are not exported.

## Sample Rate

This option in the Pro Tools Output Options dialog lets you save to any of several sample rates. If you choose a sample rate that differs from the original sample rate of the session, Pro Tools performs sample rate conversion on the bounced files. See “Conversion Quality” on page 321 for information on setting the quality of this sample rate conversion.

**48000** This is the standard sample rate for consumer-level DAT decks.

**44100** This is the standard sample rate for compact discs and pro-level DAT decks. It is also used for high-fidelity audio destined

for playback on newer Macintosh computers with 16-bit audio playback capability, as well as on Windows computers.

**22050 and 11025** These sample rates are commonly used for lower-fidelity audio destined for playback on newer Macintosh computers with 16-bit audio playback capability, as well as on Windows computers.

**22254 and 11127** These sample rates are commonly used for lower-fidelity audio destined specifically for playback on older Macintosh computers not equipped with 16-bit audio playback capability.

**Custom** This allows you to choose a sample rate other than the choices above.

## Use Squeezer

The Use Squeezer option uses a proprietary DSP algorithm specifically designed for performing 8-bit conversion of simple source files such as voice-overs. It optimizes the dynamics of the audio by preprocessing it using compression, limiting, and gating before conversion to 8-bit resolution. This results in greater apparent loudness in the signal, and improved intelligibility. If you are converting a more complex 16-bit audio file to 8-bit resolution, test this option before converting all of your material.

## Conversion Quality

The Conversion Quality option sets the quality of sample rate conversion used to create the converted file. The higher the quality of sample rate conversion, the longer it takes to convert the file after the bounce has taken place. There are five possible settings, ranging from Low to Tweak-head. For most applications, the Better setting yields satisfactory results.

Because the Best and Tweak-head settings take significantly longer than the others, use them only in cases where the highest fidelity is essential and you have a considerable amount of time to devote to this process.

---

## Using Dither on an Output Mix

Pro Tools includes a real-time Dither Plug-In that improves 16-, 18-, or 20-bit performance and reduces quantization noise when mixing or fading low-level signals.

The Dither Plug-In has no user-selectable parameters other than Bit Resolution and Noise Shaping controls.

---

☞ For more information about the Dither plug-In, refer to the *DigiRack Plug-Ins Guide*.

---

### To use the Dither Plug-In on a main stereo output mix:

- 1 Choose File > New Track and choose Master Fader (stereo) from the pop-up menu.
- 2 Set the output of the Master Fader to outputs 1-2.

- 3 Set the outputs of all audio tracks in the session to outputs 1-2. The Master Fader now controls the output levels of all tracks routed to it.

- 4 On the Master Fader, click an Insert button and choose the DigiDesign Dither Plug-In.

- 5 In the Dither Plug-In window, choose an output Bit Resolution and Noise Shaping setting.

When you use the Bounce to Disk command, the output will be processed by the Dither Plug-In.

## When to Use the Dither Plug-In

You should use the Dither Plug-In when mastering to a 16-bit file with the Bounce To Disk command, or when mastering to an external device that records at 16-bit. This is even necessary when using 16-bit sessions.

Generally, dithering is necessary when reducing the bit depth for digital audio.

Even though 16-bit sessions use 16-bit files, they are still being processed internally at a higher bit rate:

- 24-bit for Pro Tool TDM systems
- 32-bit floating for Pro Tools LE systems

For this reason, whether you are using a 16-bit session or a 24-bit session, it is recommended that you use the Dither Plug-In when mastering to 16-bits.

When mastering to 24-bits, it is not necessary to use the Dither Plug-In.

---

## Creating a Submix

You can create a submix with the Bounce to Disk command by muting tracks or bypassing inserts that are not part of the submix group, and selecting the part of the session you want to bounce.

You can also create a submix by re-recording tracks directly into your session. For details, see “Recording a Submix to Disk” on page 282.

### To bounce a submix to disk and bring it into the session:

- 1 Adjust track output levels, finalize any mix automation, and choose an automation mode for the tracks you are going to bounce.
- 2 Adjust any real-time Plug-In and effects settings and automation on the tracks you are going to bounce. If you don't want to apply a Plug-In or effect to a track, click its Bypass button in the Inserts/Sends Editor window.
- 3 Mute all the tracks you want to exclude from the submix.
- 4 Assign the output of each of the tracks you want to include in your bounce to the same output pair.
- 5 Do one of the following:
  - ◆ To bounce the entire session, click Return to Zero in the Transport window to go to the beginning of the session.
  - ◆ To bounce a portion of the session, make a selection in the Edit window.
- 6 Choose File > Bounce to Disk.
- 7 Choose either Mono or Split Stereo for the Bounce Type.

8 Make sure the bit resolution for the bounced file matches the bit resolution of the session.

9 Select the Import into Session After Bounce option.

10 In the Bounce Source pop-up menu, choose the output pair that carries the audio that you want to bounce.

11 Click Bounce.

12 Select a destination for the new audio file, enter a name, and click Save.

Pro Tools bounces are done in real time, so you hear audio playback of your mix during the bounce process.

### To bring bounced files back into tracks:

- 1 Do one of the following:
  - ◆ If the newly bounced audio was automatically imported into the session, drag the new files from the Audio Regions List to open tracks in your session.
  - ◆ If the bounced files are not available in the Audio Regions List, import them into the session by choosing File > Import Audio/Track (Macintosh) or File > Convert and Import Audio (Windows).

---

\* If you are placing both channels of a split stereo file, keep both channels in phase with each other by Shift-selecting them in the Regions List, and dragging them simultaneously into open tracks in your session.

---

2 When working with stereo tracks, set the pan controls hard left/right.

3 Mute or turn off the voices of original source tracks so that you don't double monitor your audio material.

4 Click Play in the Transport window to hear the results of the bounce.

---

## Final Mixdown

In final mixdown, you create a mix that includes all your edits, automation, and effects processing.

### To bounce a final mix to disk:

**1** Adjust track output levels, finalize any mix automation, and choose an automation mode for each track in the session.

**2** Adjust any real-time Plug-In and effects settings and automation for each track in the session.

**3** Make sure that all of the tracks you want to include in the bounce are audible (not muted).

**4** Assign the output of each of the tracks you want to include in your bounce to the same output pair.

**5** Do one of the following:

- ◆ To bounce the entire session, click Return to Zero in the Transport window to go to the beginning of the session.

- ◆ To bounce a portion of the session, make a selection in the Edit window.

**6** Choose File > Bounce to Disk.

**7** In the Bounce dialog, choose the Bounce Type.

**8** Select one of the following Bounce Options:

- ◆ To bounce the file to the same file format, bit resolution and sample rate as the current session, select None.

- ◆ To import the bounced file into the current session, select Import into Session After Bounce (this option is not available if you are bouncing to a different bit resolution).

- ◆ To convert the bounced audio file to another format, bit resolution, or sample rate, select Convert After Bounce, then click the Settings button and choose the output options.

**9** Choose the bit resolution for the bounced file.

**10** In the Bounce Source pop-up menu, choose the output pair that carries the audio that you want to bounce.

**11** Click Bounce.

**12** Select a destination for the new audio file, enter a name, and click Save.

---

## Mastering

In the final mastering process, you might record directly to disk, to a CD recorder, to a stereo mastering recorder, or for surround mixing, directly to a multi-channel recorder.

Once you have created a digital master of your session, you can transfer it to a portable medium for duplication. You may transfer the stereo master file to CD-R, DAT or 8 mm DDP tape to be used as a master for pressing compact discs.

### Mastering to a Digital Recorder

Although it is usually best to master sessions directly to hard disk, Pro Tools also allows you to master digitally, direct to any AES/EBU or S/PDIF-equipped digital recorder such as a DAT deck.

## **24-bit Input and Output with Pro Tools 24 MIX and Pro Tools 24 Systems**

Pro Tools 24 MIX and Pro Tools 24 are full 24-bit audio recording and mixing environments, supporting record, playback, mixing, and processing of 24-bit audio files. You can record to and from other 24-bit recording systems without any bit-depth conversion.

## **24-bit Input and Output with Pro Tools III Systems**

Pro Tools III TDM systems are capable of 24-bit mixing. The only 16-bit restriction is on recording and playback of audio files.

**Digital Input and Output** Because PCI-based Pro Tools III cards are capable of 24-bit data transfer, your system can send and receive digital audio with a sample size up to 24-bits directly through the digital inputs and outputs of an 888/24 I/O, 882/20 I/O, 888 I/O, or 882 I/O Audio Interface. In addition, mixing within the Pro Tools III environment (both disk tracks and live inputs to the audio interfaces) produces a 24-bit output word. This result can be dithered down to 16-bits if you are outputting to a 16-bit recorder (such as a DAT machine).

This 24-bit mixing capability is useful if you work with digital devices such as audio converters, mastering recorders, or effects devices that support 20-bit or 24-bit input and output. It allows you to mix your audio within Pro Tools with the full 24-bit resolution of the TDM mixing environment, providing greater dynamic range and a lower noise floor.

**Analog Input and Output** PCI-based Pro Tools III Systems support full 24-bit A/D and D/A from the 888/24 I/O Audio Interface; 20-bit A/D and D/A from the 882/20 Audio Interface; and 18-bit A/D and D/A from both the 888 I/O and 882 I/O Audio Interfaces. To obtain best results when recording to disk, you may want to dither your audio inputs.

---

☞ For more information about the Dither plug-In, refer to the *DigiRack Plug-Ins Guide*.

---

## **Mastering and Audio Compression**

Although audio compression is often an indispensable tool in analog recording, it can present problems in the digital domain. If you compress an input signal at a very high ratio, you create a signal that contains a much higher overall power level compared to its transients. By recording a number of such signals at the highest possible level on multiple tracks, you create a scenario that is more likely to clip the mixed output signal.

High-power compressed signals, when mixed together, create an extremely high-level output. This output may rise above the full-code level, resulting in clipping. To avoid this problem, watch the overall level of your program material—use a meter on a Master Fader, or use an external mastering deck's meters to help avoid clipping. If you are mastering to hard disk, avoid mixing full-code audio signals together at unity or "0" level, as this invariably causes clipping.



## **Mastering and Error-Correcting Media**

Random access media (such as hard disks, optical cartridges, Bernoulli cartridges or WORM drives) can produce a true digital copy of your data, because every bit value is maintained. Sequential media (such as DAT tapes) use error correction schemes to fix the occasional bad data that is received in a digital transfer. These corrections are deviations from the actual data, and with successive reproductions, represent a subtle form of generation loss.

You can avoid this loss by creating and maintaining masters on random-access digital media (such as a hard drive) and transferring them to sequential digital media (such as DAT tapes) only as needed.

### **To configure Pro Tools for direct digital stereo mastering:**

- 1** Connect your digital recorder to your system's digital outputs.
- 2** In Pro Tools set the appropriate digital format and output from the Hardware Setup or Playback Engine dialog.
- 3** On your digital recorder, choose the appropriate digital format for the connections.
- 4** In Pro Tools, set all audio tracks you want to master to outputs 1-2.
- 5** Click Return to Zero in the Transport window to go to the beginning of the session.
- 6** Press Record on your digital recorder.
- 7** Start playback of your session.
- 8** When your session has finished playing, stop the digital recorder.



# **Part VI**

## **Synchronization**



# Synchronization Concepts

Time code and synchronization (sync) are complex topics. This section is designed to give you a basic understanding synchronization as it relates to your work with Pro Tools.

However, if you are using a device that sends or receives time code, such as a video tape recorder, you need to understand how that device generates or receives time code, and how to configure its options. Refer to the manufacturer's instructions for operational details.

---

## Your Sync Requirements

We strongly recommend that you research what your synchronization requirements are. For instance, if you're using Pro Tools to accomplish audio post-production work for video, consult with your video engineer or editor to determine what time code format is being used. There may be other time code-related issues that affect how you use synchronization. Your Digidesign dealer may also be able to offer suggestions about using sync with your studio.

---

## Aspects of Sync

Synchronization has two components, which can be expressed as the following questions:

- ◆ "Where are we?" This is called the positional reference.
- ◆ "How fast are we going?" This is called the clock reference.

To sync Pro Tools accurately over an extended period of time to another device such as a tape machine or VTR, Pro Tools needs to know where the device is and at what speed it's running. Some peripherals can provide only one of these references; for example, a black burst generator or house sync provides only a clock reference. Some peripherals, like the Digidesign Universal Slave Driver (USD), can do both.

---

## Syncing Pro Tools

Pro Tools requires a clock reference—in addition to time code—in order to maintain synchronization over time.

You can resolve Pro Tools to an external clock reference without locking it to a positional reference. For instance, you can use a USD to resolve the Pro Tools sample clock to house sync, without synchronizing Pro Tools to external time code. You should do this if you need all your work in Pro Tools to match the speed of all other machines in your facility.

Let's explore this a little further using a typical sync situation, with Pro Tools being slaved, using a Universal Slave Driver (USD), to a video tape recorder, with both machines referenced to the same house sync or black burst source:

- 1** When you start the videotape, time code (LTC or VITC) is read off the tape and routed to the USD.
- 2** The USD sends Pro Tools the address of the first instance of time code it receives (positional reference). At the same time, based on the house sync or black burst clock reference, the USD sends Super Clock information to Pro Tools (clock reference).
- 3** Pro Tools takes the first time code address it receives, and calculates the sample location in the session that corresponds to the address. Though you can work with Pro Tools using any standard time code format, it calculates in terms of sample numbers—which means that it translates the time code address to an exact sample number.

**4** Assuming that the time code address corresponds to a sample number that is within the Pro Tools session, Pro Tools converts the time code address to a sample number within the session, and begins playing back from that point. The point that playback starts from is the *trigger point*. The clock reference is used by both machines to keep them in sync with each other's clocks.

**5** At this point, if the videotape is stopped, rewound, and started again, the entire process is repeated, based upon a newly calculated trigger point.

In this way, Pro Tools uses time code for positional information, and a clock reference to maintain synchronization.

## About Positional References

### Time Code and Bi-phase

The “Where are we?” question refers to relative position. To describe position, many professional audio, video, and multimedia devices and programs use SMPTE (Society of Motion Picture & Television Engineers) time code.

There are two basic techniques used to record SMPTE time code onto magnetic tape: LTC (Linear Time Code) and VITC (Vertical Interval Time Code). LTC is recorded on an audio channel or a dedicated time code track of the audio or video device. VITC is recorded within the video signal in the video “blanking area” of each video frame. VITC cannot be recorded on audio tracks, so it has no application when working with audio tape recorders, but it

does offer powerful features for post-production professionals who work with video.

There is also a non-SMPTE form of time code called MIDI Time Code (MTC) that some devices use to send timing information.

Time code is timing information in the form of a data stream that can be recorded on magnetic tape as an audio or video signal. Time code can be used to synchronize the playback and recording of your Pro Tools system with another machine's transport, such as an analog multitrack tape machine or a video tape recorder (VTR).

Time code is based on hours, minutes, seconds, frames, and subframes (1/100th of a frame). The frame is used as a unit of time measurement due to SMPTE time code's origin in film and video applications. Depending on the SMPTE frame rate, one frame is equal to 1/24th, 1/25th, 1/29.97th, or 1/30th of a second. For instance, a videotape time code reading of "01:12:27:15" would tell us that we were at a position of one hour, twelve minutes, twenty-seven seconds, and fifteen frames.

Because SMPTE stores an absolute time reference on the tape in the form of time code, any location on that tape can be precisely located by devices that read time code. Once the time code has been recorded or "striped" on a tape, it provides a permanent time reference that allows Pro Tools to link the playback of an event to an exact tape location. For example, with time code sync, a gun shot sound effect can be played at the precise instant that the gun's flash appears on-screen.

## **LTC (Linear Time Code)**

LTC is time code that is recorded and played back in the form of an analog audio signal. LTC is supported by many audio and video tape recorders.

### **LTC Speed Usage**

LTC can be read at high tape shuttle speeds, allowing a machine's time code reader to communicate with synchronizers at rewind or fast forward speeds exceeding 50 times playback speed (provided the tape recorder is able to reproduce the time code at this speed). However, LTC cannot be read at very slow shuttle speeds (such as when you are "crawling" the tape frame by frame) or when the machine is paused. With LTC, the VTR must be running (usually at a minimum speed of about 1/10th normal playback speed) in order to capture a SMPTE time address.

## **VITC (Vertical Interval Time Code)**

VITC is a type of time code that's recorded and played as an invisible part of a video signal. VITC is commonly used in professional video editing and audio-for-picture applications. Because VITC is recorded as part of each video frame, it must be recorded at the same time as the video signal—it cannot be added later as LTC can. Since VITC cannot be recorded on audio tracks, it is never used to synchronize audio-only recorders. As a result, LTC is more commonly used in audio-only applications.

## VITC Speed Usage

VITC's ability to capture a time code value when moving a VTR transport at slow speeds or when the VTR is paused makes it more useful in audio post-production environments than LTC.

When VITC is used, Pro Tools captures the current SMPTE time from the VTR when it is paused or in "crawl" mode. However, if you are using additional external transport synchronizers in your setup, most synchronizers cannot read VITC at speeds exceeding about 10 times playback speed, preventing slaved machines from maintaining synchronization during rewind and fast forward.

## LTC/VITC Auto-Switching

Many synchronizers and devices support automatic switching between LTC and VITC, depending on the speed, to get the best of both worlds. For example, VITC might be used when a VTR is paused, or crawling frame-by-frame, while the synchronizer might automatically switch to LTC when fast-forwarding.

## Bi-Phase/Tach

This electronic pulse stream is used by film mag recorders, film editing stations, and film projectors. You can use this format to synchronize Pro Tools if you have a USD. Unlike time code, bi-phase/tach doesn't actually contain absolute location information. It simply supplies speed (based upon the frequency of the pulses) and direction, and therefore, relative position. Since the USD can "count" both the speed and direction of the stream of pulses, it can use a bi-

phase/tach source to deduce positional information from a starting "address point." The difference between bi-phase and tach formats is that bi-phase encodes rate and direction on a pair of signals using a format called phase-quadrature, while tach encodes rate on one signal and direction on the other.

---

## SMPTE Frame Formats

Six different formats of SMPTE time code exist, and Pro Tools can sync to any format with a compatible sync peripheral. The supported SMPTE frame rates are:

- 30 FPS (frames per second), also called 30 Non-Drop
- 30 FPS Drop frame
- 29.97 FPS, also called 29.97 Non-Drop
- 29.97 FPS Drop frame
- 25 FPS (also called EBU)
- 24 FPS

---

\* When you work with NTSC video (the standard in North America), you will generally work with the NTSC color video standard: either 29.97 FPS Non-Drop or 29.97 FPS Drop frame.

---

## 30 FPS Frame Format

This format is based on a frame rate of 30 frames per second. This is the original SMPTE format developed for monochrome (black & white) video, and is commonly used in audio-only applications. This format is often referred to as 30 Non-Drop frame format.



## **30 FPS Drop Frame Format**

This format is used for sound recordings done for film-originated programs that are destined for NTSC broadcast.

## **29.97 Non-Drop Frame Format**

This format is used with NTSC color video. It runs at a rate of 29.97 FPS.

## **29.97 Drop Frame Format**

NTSC color video has an actual frame rate of 29.97 FPS, so an hour's worth of frames (108,000) running at 29.97 FPS Non-Drop will take slightly longer than one hour of real-time to play. This makes calculating the actual length of a program difficult when using 29.97 Non-Drop time code. A program which spans one hour of 29.97 Non-Drop time code addresses (e.g. from 1:00:00:00 to 2:00:00:00) is actually 60 minutes, 3 seconds and 18 frames long.

To make working with 29.97 time code easier for broadcasters, the SMPTE committee created 29.97 Drop Frame time code, which runs at exactly the same speed as 29.97 Non-Drop (non-drop frame) time code, but compensates for the slower speed by “dropping” (omitting) two frames at the top of each minute, with the exception of every 10th minute. For this reason, the time code address of 1:01:00:00 does not exist in drop frame code because it has been skipped.

At the end of a program which spans precisely one hour of drop frame time code (1:00:00:00 to 2:00:00:00 for example), exactly one hour of real time has elapsed.

Although it sounds complicated, drop frame time code allows broadcasters to rely on time code values when calculating the true length of programs, facilitating accurate program scheduling.

## **25 FPS Frame Format**

This format is used with the European PAL video standard, which runs at a 25 FPS frame rate. This format is also called the EBU (European Broadcast Union) format because it's used by broadcasters throughout most of Europe.

## **24 FPS Frame Format**

This format is used exclusively for film applications. Film is typically photographed and projected at a 24 FPS frame rate, so this SMPTE format is useful when one time code frame should equal one film frame.

---

## **Working with Film-Originated Material**

When you do post-production work in Pro Tools, you will usually work with video material. However, it is possible that the video you are working on was shot on film.

Film footage and production sound go through separate conversion processes before they reach video, and the audio post-production stage. The film is transferred to video using a process called Telecine, using a method called 3:2 Pulldown. Audio can also be pulled down during the transfer, or you might end up working with audio that has not been adjusted (production sound).

Typically during the Telecine process, a master digital video tape is created, along with a work copy on 3/4" analog video tape for the picture editor to use. At the same time, a new audio master may be created by slowing down, or "pulling down" by 0.1%, to compensate for the change in speed from film to NTSC video.

## Guide Tracks

In the Video editing process, the audio track produced by the video editor (the "guide track") is rough and needs to be enhanced and improved by the audio engineer. For this reason, the audio engineer will need to re-edit the original sound elements in a process known as *conforming*.

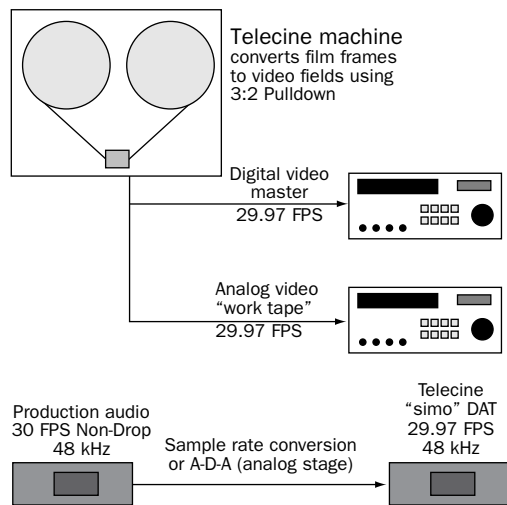

The Telecine stage of video post-production

## 3:2 Pulldown

A film clip that lasts 1000 seconds consists of 24,000 film frames (pictures). If you want to transfer that film to 1000 seconds worth of NTSC color video, you have to "fit" 24,000 film frames into 29,970.02997 video frames.

If we use the black and white NTSC video standard (30 FPS) instead of 29.97 FPS, the process of converting film frames to video frames is greatly simplified. Now instead of any fractional frames, we have 24,000 film frames going into 30,000 video frames (60,000 video fields). In the Telecine process (for NTSC color video), each odd film frame is copied to two video fields, and each even film frame is copied to three video fields, creating what is called a 3:2 Pulldown. The speed of the film is also "pulled down" to 23.976 FPS in order to accommodate the slower speed of NTSC color video compared to NTSC black and white video (29.97 FPS compared to 30 FPS).

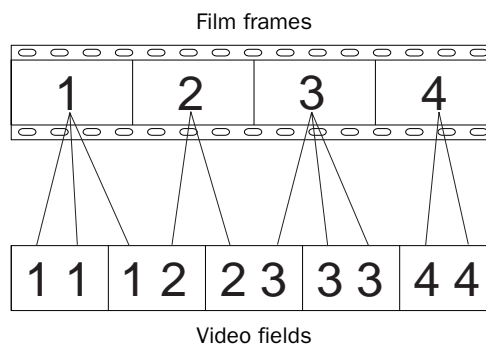

How film frames translate to video fields in a 3:2 Pulldown

## Film Speed Differs from NTSC Video Speed

The new NTSC Telecine master tapes will always run at 29.97 FPS during post-production, so the original production sound rolls (at 30 FPS) will be too fast, and therefore out of sync with the video. Some adjustment of this audio may be required.

When spotting audio to video that was transferred from film to NTSC video, there are two important terms to keep in mind: film speed and video speed.

**Film Speed** Film speed refers to audio that was recorded and plays back in synchronization with the film camera. This audio comes from production reels recorded on a Nagra® recorder or a field DAT recorder, and is usually striped with 30 Non-Drop time code. Film speed audio runs at the same speed as the film camera or projector, and is therefore out of sync with 29.97 video.

**Video Speed** Video speed refers to audio that is running at the NTSC color standard of 29.97 FPS. Video speed is 0.1% slower than film speed, so audio that is still at film speed is out of sync with the video. Usually, you will be working at video speed, though Digidesign and Avid do provide several options for film speed (24 FPS) support.

## Pull Up and Pull Down

Pull Up and Pull Down are terms used to refer to the deliberate recalibration of the audio sample rate clock (speed, or musical pitch) in order to compensate for a speed change. Pro Tools can be used to Pull Down

or Pull Up audio for use with NTSC video. Pro Tools does not support Pull Up or Pull Down sample rates for PAL video.

Pull Up and Pull Down are based on the concept of matching the change in audio speed to the change in video speed. Because film that has been transferred to NTSC videotape has been slowed down by 0.1%, the same varispeed (or “pull-down”) must be applied—at some stage of the audio production process—to any production sound, to maintain sync.

Using Pro Tools in Pull Up or Pull Down modes requires a USD, SSD, or a third-party synchronizer that supports 256x clock output and Pull Up and Pull Down sample rates. The VSD can be used for Pull Down, but does not support Pull Up mode.

## When to Pull Up or Pull Down

There are many ways to get audio into Pro Tools for post-production. Consider your source audio and your final destination format carefully. In some cases, audio will already be pulled down for you. In other cases, audio will have to be temporarily pulled down. In still other cases, you may choose to pull down your audio source, like a DAT deck, then use a D-A-D (digital-to-analog-to-digital) conversion to record the audio into Pro Tools at the proper sample rate. Or you may choose only to pull Pro Tools up or down on delivery of the audio. Refer to the online document *FilmSync.pdf* installed with your Pro Tools documentation, for detailed Pull-Up/Pull-Down workflow information.

### **Final Audio Destination: Film**

If your final destination is film, your source audio is at film speed, and your goal is to edit and mix audio in Pro Tools and then lay back to a device that runs at film speed (such as Mag or Time Code DAT), you can temporarily Pull Down the audio in Pro Tools for NTSC video work, then return the audio back to film speed when you're finished.

For example, film speed audio from a Nagra machine that is referenced to 30 FPS time code is recorded into your Pro Tools system at a sample rate of 44.1 or 48 kHz. Keeping in mind that film speed is faster than video speed, select 30 FPS in your Session Setup window in Pro Tools, and record in your audio online and referenced to the time code on the Nagra.

Once all the audio has been recorded, and you are locked to a video work print (at "video speed"), set up Pull Down. If you are using a Digidesign USD, SSD, or VSD, select Pull Down in the Session Setup window. (You also have to select Pull Down manually on the front of the VSD.) If your synchronizer is not a Digidesign product, select Pull Down on the front of your synchronizer, then enable Pull Down in the Pro Tools Session Setup Window. At this point, it is highly recommended that you verify whether the video you're working with is striped with 29.97 Drop Frame or Non-Drop Frame time code. While in Pull Down mode, you can work with your reference video and everything will remain in sync and run at the proper speed (assuming your system is completely resolved).

Once you are ready to lay back your completed project to an audio device running at film speed, deselect Pull Down in the Session Setup Window, and from your synchronizer if it is not a USD or SSD. Then change your time code frame rate in the Pro Tools session back to 30 FPS. Once Pull Down has been deselected, the audio played back from Pro Tools will synchronize perfectly with the edited film.

Alternately, you can pull down the source audio deck while recording audio into Pro Tools, work at 29.97 FPS with no Pull-Down selected in Pro Tools, and then switch to 30 Non-Drop frame format, and select Pull Up during the delivery stage. You will have to perform a sample rate conversion the audio either digitally or by using an analog stage (D-A-D).

### **Final Audio Destination: Video**

If you are working with video that was transferred from film, your audio source is at film speed, and the final layback destination is NTSC video (or television), and you would like to provide a digital transfer to your clients, you will need to alter the above recipe slightly. Keep in mind that when you are working in Pull Down mode, your active sample rate is 44.056 kHz (if the audio was recorded at 44.1 kHz) or 47.952 kHz (if the audio was recorded at 48 kHz).

### **Pull Down the Audio Source**

Some professional DAT machines will let you Pull Down the sample rate to 44.056 kHz, then you can record this audio into Pro Tools using a D-A-D (digital-to-analog-to-digital) process. Then your audio will be at the correct speed for the remainder of the project, since the final destination is video, and no Pull Down or Pull Up is necessary.

### **Pull Up Pro Tools While Recording**

If you cannot Pull Down your source, you can accomplish the same thing by Pulling Up Pro Tools, and setting your SMPTE frame format to 30 FPS, before recording in the production sound. First select 30 FPS as the frame format in the Session Setup Window. Then select Pull Up in the Session Setup window (and on your synchronizer if it isn't a USD or SSD) before you record in the production audio. In this case, while the production audio is running at 44.1 or 48 kHz, Pro Tools is running (and recording) at a rate of 44.144 or 48.048 kHz. After all the production audio has been recorded into Pro Tools, deselect Pull Up in the Session Setup window and on your hardware synchronizer if it is not a USD or SSD. After you deselect Pull Up, the recorded audio will play back 0.1% slower, synchronized with the video, while achieving a true playback sample rate of 44.1 or 48 kHz. Note that this process is designed for a final destination of video; to bring this audio back up to film speed you would have to Pull Up Pro Tools and record to a destination that is not Pulled Up.

### **Note on Sample Rate Conversion**

In many cases, you have to perform a sample rate conversion at some point, either digitally, or by recording in audio using an analog stage (D-A-D). The only situation where sample rate conversion never has to be performed is when you are working with film speed audio and your final destination format is film. Then you can simply Pull Down Pro Tools while you work with the video, then deselect Pull Down to set the audio back to film speed.

### **Using Digital Input**

Do not set Pro Tools channels 1 and 2 to Digital Input format while working with Pull Up or Pull Down. This will override any clock reference information, such as the Reference Video information from a USD.



# Time Code Synchronization

Synchronization (sync) allows connected systems or devices to start and stop their transports together, and, in some cases, to adjust transport speeds to maintain accurate synchronization of audio and video material during playback. Pro Tools is synchronized to other devices using SMPTE time code or MIDI Time Code. For a discussion of different SMPTE formats, and other concepts related to time code, refer to *Chapter 23: Synchronization Concepts*.

---

## Pro Tools Sync Options

You have four choices for synchronizing Pro Tools to an external source:

### **SMPTE Trigger only**

This solution is useful for short projects, but may result in timing errors if you are working with lengthy program material and an unstable sync source. This is the only option available on Pro Tools LE systems.

### **SMPTE Trigger with an Externally Resolved Peripheral (TDM Systems Only)**

This solution uses a Universal Slave Driver (USD), Video Slave Driver (VSD), or equivalent third-party device, resolved with a black burst or “house sync” generator, or using external word clock, to control playback and recording speed in Pro Tools. Accurate long-term sync can be achieved when all transports within the system are resolved to a common sync source.

### **SMPTE Trigger with an External Peripheral Slaved to LTC**

SMPTE Trigger can be used with the optional USD, SMPTE Slave Driver (SSD), or equivalent third-party device to resolve Pro Tools recording/playback speed while slaving to LTC. This enables long-term, accurate synchronization by resolving to any variations in incoming time code.

## SMPTE Resolved with USD

### (TDM Systems Only)

You can use the optional USD, or an equivalent third-party device, to resolve Pro Tools recording/playback speed with any of the following clock reference sources while slaving Pro Tools to LTC:

- Video source
- Video “blackburst” or “house” sync
- VITC
- 1x Word Clock
- AES/EBU “null” clock
- 256x slave clock
- Pilot Tone
- Bi-Phase

This enables long-term, high-fidelity synchronization when all transports within the system are resolved to this common sync source, or by resolving to any variations in incoming time code while slaving to LTC.

## Other USD and SSD Sync Options

By adding a USD or SSD to your Pro Tools TDM system, you can use Pro Tools as the master device in your synchronization setup. All other devices are then slaved to Pro Tools.

You can use Pro Tools in conjunction with either the USD or SSD to generate SMPTE LTC, MIDI Time Code, Slave Clock, or MMC messages. When either the SSD or USD is reading incoming SMPTE time code from the SMPTE In connector, it regener-

ates the time code through the SMPTE Out connector. This signal can be passed along to other slave devices.

For instructions on connecting an external sync peripheral to your Pro Tools system, refer to the instructions in the *Pro Tools Hardware Installation Guide*.

## The Session Setup Window

The Session Setup window allows you to configure various time code-related parameters on your system. The following settings can be adjusted in this window:

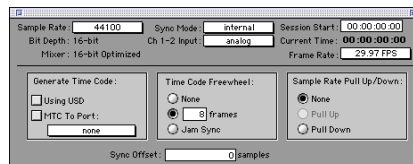

Session Setup Window

### Sample Rate

This allows you to set the sample rate for the current session. Choices are 48,000 Hz (48 kHz) or 44,100 Hz (44.1 kHz). 44,100 Hz is the sample rate used on audio compact discs.

### Bit Depth

This display-only area indicates the bit depth for the current session.

### Mixer

This area indicates the type of the Pro Tools mixer in use. On TDM systems, the mixer field will display the current mixer in use:



either 16-bit Optimized or 24-bit Optimized. “CPU Mixer” is displayed in this field on a Pro Tools LE system.

## **Ch 1-2 Input**

### **(TDM Systems Only)**

This allows you to choose an audio input format (analog or digital) for channels 1 and 2 of your master Audio Interface.

### **Sync Mode**

This allows you to choose the clock mode for your master Audio Interface, Audiome- dia III card, or Digi 001. Choices are Internal or Digital on an Audio Interface or Audiome- dia III card, and Internal, Optical, or S/PDIF (RCA) on the Digi 001.

**Internal Sync Mode** In internal sync mode, your system will reference your Digidesign card or peripheral’s quartz crystal oscillator and play back at the sample rate selected in the Sample Rate field.

**Digital Sync Mode (including Optical and S/PDIF on Digi 001)** In digital sync mode, your system’s sample rate is adjusted to match the sample rate received from the selected digital peripheral. In digital sync mode, your Pro Tools sync rate must match the rate received by your digital peripheral. Incorrectly set peripheral devices will result in incorrect playback speeds when your system is set back to internal sync mode.

With TDM systems, the Session Setup win- dow provides a source link feature that tog- gles the sync mode of your audio interface when you switch your input source from analog to digital. This helps to ensure that

the clock source for your system will match the digital input source when you are working.

You can override this toggled behavior by changing the pop-ups to the opposite choice. For example, if you are using a mas- ter AES/EBU null clock or video black burst signal source as the master sync source for all digital audio devices in your studio setup, your Sync Mode pop-up should be set to digital at all times. In this case, Pro Tools uses this master sync source as a reference.

### **Session Start**

This allows you to specify a SMPTE start frame location for your session. The SMPTE value that you enter here will be used to trigger playback and record when Pro Tools is online. See “Setting a SMPTE Start Frame” on page 344.

### **Current Time**

This displays incoming time code.

### **Frame Rate**

This allows you to set the SMPTE frame rate for the current session.

### **Generate Time Code**

This allows Pro Tools to output time code using a USD (communicating directly via a serial port), or using a SSD (communicating via a serial port or using MIDI sys-ex via a designated OMS destination port). Gener- ating time code is covered in the section “Generating Time Code” on page 347.

**Using Peripheral** This option outputs time code from the Device type selected in the Synchronization page of the Peripherals dialog.

**MTC to Port** This option outputs MIDI Time Code to the MIDI destination selected in the pop-up menu.

### **Time Code Freewheel**

This allows Pro Tools to continue playback if time code is interrupted or corrupted. Use this to protect against errors that can occur if your SMPTE time code source has “drop outs” or temporary lost signals.

**Frames** This option allows you to freewheel from 1 to 120 frames. This value defaults to 8 frames which is the recommended setting for most applications.

**Jam Sync** This option allows Pro Tools to trigger sync to incoming time code, and continue to play back even if time code input is completely interrupted. It can be useful if time code is damaged, or has been accidentally erased from your source tape.

### **Sample Rate Pull Up/Down**

When Pro Tools is used in conjunction with a SSD, VSD, USD, or third-party synchronizer that supports 256x clock output and Pull Down sample rates, this option allows you to “pull up” or “pull down” the current sample rate. This is used with film-originated material when working with NTSC-standard SMPTE frame rates only. For a full explanation of film-originated scenarios, see “Working with Film-Originated Material” on page 333.

**Pull Up** This speeds up the current sample rate to 100.1%. A 48 kHz sample rate is sped up to 48.048 kHz. A 44.1 kHz sample rate is sped up to 44.144 kHz.

**Pull Down** This slows the current sample rate to 99.9%. A 48 kHz sample rate is slowed to 47.952 kHz. A 44.1 kHz sample rate is slowed to 44.056 kHz.

### **Sync Offset**

This field allows you to set a “trigger offset” for incoming MIDI Time Code (anywhere from -100000 to +100000 samples). This allows you to create a permanent offset to fine-tune the point at which Pro Tools syncs relative to incoming time code. For example, a value of -50 makes an event in Pro Tools occur 50 samples before the same event in the incoming MIDI Time Code. Use this to compensate for timing differences between various SMPTE-to-MIDI Time Code converters or analog-to-digital/digital-to-analog converters.

---

▲ For TDM systems, recording with a Sync Offset requires two voices for each record-enabled track. In addition, to simultaneously record on 32 tracks with a Sync Offset on a Pro Tools 24 MIX system (which allocates voices to either of two DSP engines, 1–32 and 33–64), the tracks must be evenly distributed between the two DSPs, (for instance, tracks 1–16 assigned to voices 1–16 and tracks 17–32 assigned to voices 33–48).

---

## Variable Speed Override

Variable Speed Override (VSO) requires a USD (or SSD). When a USD is connected to Pro Tools, the Session Setup window expands to display additional controls for VSO, clock, and Positional Reference (see Figure 23).

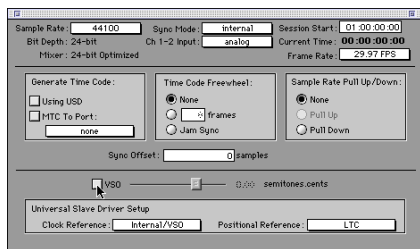

Figure 23. Session Setup window with USD

Refer to the *Universal Slave Driver User's Guide* for instructions on using VSO to varisped Pro Tools playback.

---

## Preparing to Work with SMPTE

The first step when preparing to work with SMPTE is to choose an appropriate SMPTE frame rate.

### SMPTE Formats

Pro Tools supports all standard SMPTE frame rates. For a full explanation of these SMPTE frame rates, see “SMPTE Frame Formats” on page 332.

## Determining SMPTE Frame Rate

Of course, it's always best to determine the SMPTE frame rate through labeling procedures or communication, but this is not always possible.

If you do not know the frame rate of a tape, the SSD and USD show incoming frame rate on their front panel LED indicators. These devices cannot distinguish between 29.97 fps and 30 fps, but they can determine whether the incoming frame rate is drop frame or non-drop frame. With NTSC video, the frame rate is most likely 29.97 fps Drop or 29.97 fps Non-Drop.

---

## Configuring Pro Tools for SMPTE

\* MachineControl is supported on TDM systems only.

Synchronization and MachineControl™ system parameters are set in the Pro Tools Peripherals dialog box. These parameters, such as sync peripheral setups, MIDI Machine Control, MachineControl, and machine pre-roll, are *system* settings, and remain constant regardless of the particular session you are working on.

Other parameters, which are configured in the Session Setup Window, such as the session frame rate, the session start frame, and time display format, are *session-specific* parameters. These parameters can only be configured when a session is open.

## Selecting a SMPTE Format

### To choose a SMPTE format:

- 1 Choose Windows > Show Session Setup.
- 2 In the pop-up Frame Rate menu, select the SMPTE frame format appropriate to your session.
- 3 Enter the Time Code Freewheel frames (if any) in the designated box. See “Time Code Freewheel” on page 342 for more information.

## Setting a SMPTE Start Frame

The Session Setup window also allows you to set a SMPTE Start Frame for your session. Video work tapes are rarely striped beginning at a SMPTE frame address of 00:00:00:00. You can quickly enter a start time for your session based on an appropriate frame number from your project tape. The Pro Tools SMPTE-related functions (such as Spot mode) will then use this value as their reference for the session’s start point.

### Start Time When Striping Tape

If you are generating time code, it is a good practice to stripe your time code beginning at 01:00:00:00. This prevents problems that can occur with some synchronizers when the striped time code crosses from 23:59:59:29 to 00:00:00:00 (commonly referred to as the “midnight” boundary).

### To set a SMPTE Start Frame for your session:

- 1 Choose Windows > Show Session Setup.
- 2 Enable playback of your SMPTE time code source. Any SMPTE-to-MTC converter device you are using should indicate that it is properly receiving time code via its indicators. If Pro Tools is receiving MTC (or proprietary sync code via the USD), the Current Time counter will update its display (in bold numbers) to match the incoming code.



*Current Time displayed in Session Setup window*

This display is useful for troubleshooting time code problems, and it should update regardless of the current Pro Tools Session Start time.

- 3 Enter a SMPTE frame number in the Session Start field.

– or –

- 4 To capture an incoming SMPTE address, press the Equal key (=). You can then edit the captured address. The session uses the frame number you enter as its SMPTE start frame when online.

If there are existing regions on the tracks and you are changing the original SMPTE start frame to a later time (from 00:00:00:00 to 01:00:00:00, for example), all existing regions on tracks will remain in their relative positions, but will start later by the time value added to the start frame.

5 If there are existing regions on the tracks and you are changing the original SMPTE start frame to an earlier time, do one of the following:

- Click Maintain Time Code to place the additional session time at the start of the session, and keep existing regions in their original time code locations.

– or –

- Click Maintain Relative Position to place the additional session time at the start of the session, and maintain the relative position of existing regions to the new start frame. For example, if you change the session start frame from 01:00:00:00 to 00:59:00:00, Pro Tools adds one minute of session time to accommodate the new start frame, and moves all existing regions earlier in time to maintain their relative position to the start frame.

## Displaying Time in SMPTE Frames

### (TDM Systems Only)

You can set the Main Current Location Indicator to Time Code to. Though Pro Tools will still synchronize to incoming SMPTE time code if the Time Scale is displayed in Bars|Beats, Minutes:Seconds, or Feet.Frames, it is usually more useful to use SMPTE Time Code as your reference.

### To set the Main Time Scale to SMPTE Time Code:

- Choose Display > Time Code
  - or –
- Click the Main Time Format selector in the Edit window, and select Time Code.

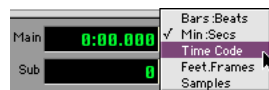

### Selecting a Time Scale format

Pro Tools will display time code values in the currently selected SMPTE frame rate.

## Sub Time Scale Display

You can also display a Sub Time Scale. For example, if your Main Time Format is set to Time Code, and you want to compare SMPTE time to “wall clock,” when you are using 29.97 Non-Drop frame rate, you can select Min:Secs as the Sub Time Format display.

## Configuring Pull Up/Pull Down using a USD or SSD

If you have a Digidesign USD or SSD and are working with material that has been pulled down or up, do the following:

### To work with a pull down/up sample rate:

- 1 Choose Setups > Peripherals and click Synchronization.
- 2 Choose the Universal Slave Driver or SMPTE Slave Driver from the Device pop-up menu and select the appropriate port from the Port pop-up menu.

**3** Choose Windows > Show Session Setup. Notice the additional field for the SSD or USD at the bottom of this window.

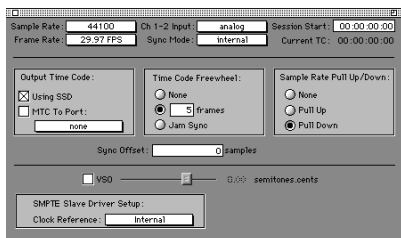

*Session Setup window showing the SSD enabled*

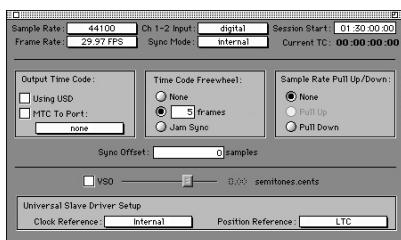

*Session Setup window showing the USD enabled*

**4** Choose the frame rate for your session from the pop-up menu. This frame rate might be 30 FPS (Drop or Non-Drop) or 29.97 FPS (Drop or Non-Drop) depending on the requirements of your material. See “When to Pull Up or Pull Down” on page 335 for more information.

**5** In the Sample Rate Pull Up/Down field, enable the Pull Up or Pull Down option as appropriate.

This procedure will also work with a VSD or a third-party synchronizer that supports 256x Super Clock and Pull Up/Pull Down, with the following exceptions:

- You have to enable Pull Up or Pull Down in the Session Setup window *and* on the front of your synchronizer, and
- The VSD does not support Pull Up sample rates.

---

## Putting Pro Tools Online

To trigger playback or recording from an external source, you put Pro Tools *online*, or set it to look for incoming time code.

### To put Pro Tools online:

**1** Choose Operations > Online. The Current Position Indicator at the upper right of the Pro Tools window will display incoming Time Code as soon as Online playback begins.

**2** Click the Online button at the far left of the Transport. The button blinks until Pro Tools locks to Time Code, then is highlighted. Pro Tools now waits for a SMPTE frame to trigger playback. The Current Time field in the Session Setup Window will indicate incoming time code.

You can take Pro Tools offline by choosing Operations > Online a second time.

## Recording Online

The Operation page of the Preferences dialog (Setups > Preferences) contains two options that affect how Pro Tools initiates recording when online.

**Record Online At Insertion/Selection** Online recording begins wherever you have placed the insertion point in a track. Recording then continues until Pro Tools stops receiving time code. If you make a selection in a track, Pro Tools will record online only for the length of the selection.

### Record Online at Time Code (or ADAT) Lock

Online recording begins as soon as Pro Tools receives and locks to time code or ADAT sync. In this case, you don't need to make an insertion or selection in a track to designate a start point.

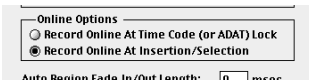

Online recording options

---

## Generating Time Code

This section describes how you generate time code from Pro Tools using the SSD or the USD.

### To generate time code using the SSD:

- 1 On a Macintosh, make sure the OMS Standard Interface Driver is installed in the OMS Folder inside your System Folder. If necessary, run the Pro Tools Installer to install OMS with the OMS Standard Interface Driver. On a Windows PC, make sure your MIDI interface is installed correctly.
- 2 Connect the SMPTE OUT connector of the SSD to the SMPTE IN connector of the device(s) you are slaving. If you are slaving a device that recognizes MTC and you wish to use MTC instead of SMPTE, connect the MTC OUT connector of the SSD to the MIDI IN connector of the device you are slaving.
- 3 On a Macintosh, make sure your SSD is powered on and connected to the Modem or Printer port. Also, make sure that the Mac Port/MIDI Port switch on the back of the SSD is set to Mac Port. On a Windows PC, connect the MTC OUT connector on the SSD to a MIDI IN connector on your MIDI interface, then connect to MIDI in connector on the SSD to a MIDI OUT connector on your MIDI interface. If you are using Windows, skip to step 14.
- 4 On a Macintosh, choose Setups > OMS Studio Setup.
- 5 Choose Setup > MIDI Cards and Interfaces, and click Update Setup.
- 6 Select the port that the SSD is connected to, then click Search.
- 7 Confirm that “Std. Interface” appears in the OMS Studio Setup window. Save the document and make it your current setup.
- 8 Double-click the “Std. Interface” icon.
- 9 Set it to 1 MHz, and deselect the Synchronizer option.
- 10 Choose Studio > New Device, and name the device “SSD.”
- 11 Deselect “Is controller” and “Is multi-timbral,” and enable both “Sends” and “Receives” MIDI Time Code, then click OK.
- 12 In the OMS Setup window, connect the SSD icon to the “Std. Interface” icon.
- 13 Choose Setups > Preferences. Be sure both the “Use Serial DMA driver when available” and “Report serial overrun and framing errors” options are deselected, and click OK. If you have to change this setting, you must restart your computer.
- 14 In Pro Tools, choose Setups > Peripherals, and select the Macintosh port or MIDI interface port that the SSD is connected to.

**15** Choose Windows > Show Session Setup and choose the appropriate frame and sample rates.

**16** In the Generate Time Code field, select the “Using SSD” option.

**17** Select the desired Clock Reference mode from the Clock Reference pop-up menu in the Session Setup window.



#### Selecting the Clock Reference for the SSD

**18** Put Pro Tools online (see “Putting Pro Tools Online” on page 118) and click Play.

When playback begins, Pro Tools generates time code via the SSD. If Pro Tools detects incoming time code on its sync peripheral, it locks to the incoming code (as in normal online operation).

## Generating SMPTE or MIDI Time Code Using a USD

Using a USD, Pro Tools can generate SMPTE or MTC. You can then make Pro Tools a master synchronization source with other devices slaved to it.

---

▲ The USD cannot generate 24 FPS time code while it is locked to a video clock signal. If you set Pro Tools to generate 24 FPS time code while the USD is locked to a video clock signal, the USD will actually generate at the NTSC color standard 29.97 Non-Drop Frame rate. Pro Tools can generate time code at non-NTSC frame rates if you use the USD’s internal clock as a sync source.

---

### To generate time code using a USD:

**1** Connect the SMPTE out of the USD to the SMPTE in connector on the device(s) you are slaving. Refer to the *Universal Slave Driver User’s Guide* to determine how to make these connections for your system. If you are slaving a device that recognizes MTC and you wish to use MTC instead of SMPTE, connect the MTC OUT connector of the USD to the MIDI IN connector of the slaved device.

**2** Make sure your USD is powered on.

**3** In Pro Tools, choose Setups > Peripherals and click Synchronization.

**4** Select USD from the Device pop-up.

**5** Select the Macintosh port or Windows serial port where the USD is connected.

**6** Choose Windows > Show Session Setup, and choose the appropriate frame and sample rates.

**7** In the Generate Time Code field, select the “Using USD” option.

**8** Click on the Clock Reference pop-up menu to show USD modes. Select the desired clock reference.

– or –

On the front panel of the USD, set the desired clock reference mode.

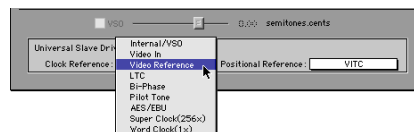

#### Selecting the Clock Reference for the USD



**9** Close the Session Setup window. Confirm that your chosen parameters have been received by the USD. If not, check your connections and the settings in the Session Setup Window.

**10** Click the Online button on the Transport, then click Play. Pro Tools generates and outputs time code from the USD.

---

## Syncing a Sequencer to Pro Tools on the Macintosh

A common application for generating time code with Pro Tools is slaving an OMS-compatible sequencer to a Pro Tools session.

### Setting the Clock Master

The exact synchronization setup your sequencer requires will vary depending on the software and your OMS setup, but Pro Tools must be the clock master. Since Pro Tools provides the audio sample clock for your system, synchronization errors will occur over time if Pro Tools is not designated as the master.

The following instructions describe the general procedure, using Opcode's Vision software as an example and Pro Tools as the master.

---

\* You can also use Pro Tools MMC to synchronize with an OMS/MMC-compatible sequencer or an external MMC-compatible device such as an ADAT or DA-88. See "Controlling External Devices using MMC" on page 351.

---

### To slave an OMS-compatible MIDI sequencer to Pro Tools:

**1** Make sure the OMS IAC Driver is installed in the OMS Folder inside your System Folder. If necessary, run the Pro Tools Installer to install OMS with the OMS IAC driver. (Refer to the *Pro Tools Software Installation Guide* for details.)

### In OMS Setup:

**2** Choose Setups > Preferences, and make sure the "Use Apple Serial DMA driver when available" option is not selected. Click OK.

---

▲ Always make sure the Apple Serial DMA driver is not being used by OMS. It can prevent proper communication with MIDI devices. You must restart your computer any time you enable or disable the Apple Serial DMA driver.

---

**3** Choose Setups > OMS MIDI Setup, and select the "Run MIDI in background" option.

**4** Choose Studio > MIDI Cards & Interfaces, click Update Setup, enable the appropriate ports, then click Search.

**5** Confirm that the OMS IAC driver appears in the OMS Studio Setup window. If it does, save the document and make it your current setup.

**6** In the OMS Studio Setup window, define an IAC Bus by double-clicking the IAC Driver icon, and typing IAC1, for example, in the first field (this provides a unique name for this particular IAC bus).

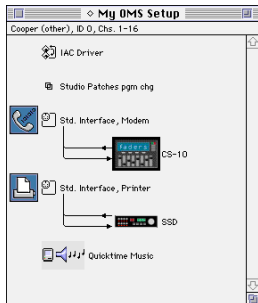

**IAC Driver icon in the OMS Studio Setup**

### In Opcode Vision:

- 7** In the Enable Input Devices window in the Setups menu, enable IAC1 (the IAC bus you defined/named previously).
- 8** Choose Operations > Sync Options.
- 9** In the Sync Options dialog, set the Receive Sync Mode pop-up to MIDI Time Code.
- 10** Next, set the Receive Sync Device pop-up to IAC1.
- 11** Select the SMPTE Format (frame rate) that will match Pro Tools (29.97 non drop, for example). Click OK to close the Sync Options dialog.
- 12** In Vision's Control bar, set the sequence start time, for example, at one hour (01:00:00:00). The Offset at the top of the Sequence window should usually match the Offset in Pro Tools.
- 13** Select Wait Note in the Transport.
- 14** Click Play or press the Spacebar. Vision should now be ready to start synchronized playback.

### In Pro Tools:

- 15** Select Operations > Active in Background.
  - 16** Choose Windows > Show Session Setup.
  - 17** In the Session Setup window, choose an appropriate frame rate.
  - 18** Select the SMPTE Start Frame to match the offset in Vision. If the sequence starts at the very beginning you could set the Pro Tools Session to start earlier (for example, at 00:59:58:00) to allow some pre-roll.
  - 19** Enable the MTC to Port option in the Output Time Code box. In the pop-up menu just below the MTC to Port option, choose IAC1.
  - 20** Close the Session Setup window.
  - 21** Click Play or press the Spacebar to start playback. Pro Tools will send MIDI Time Code to Vision via the IAC port and trigger synchronized playback for Vision. Click Stop in the Transport or press the Space bar again to stop playback.
- Once synchronized playback is operating correctly, you can record new takes in Pro Tools while listening to MIDI playback from your sequencer. Follow the procedure described above for synchronized playback, then record new material in Pro Tools by following the recording procedures in the Recording section of this manual.
- You should also be able to record new MIDI tracks while the sequencer is slaved to Pro Tools. See your sequencer documentation for details on recording while the sequencer is in an external synchronization mode.

---

## Syncing a Sequencer to Pro Tools in Windows

**To synchronize Pro Tools to a Windows sequencer:**

- 1** Make sure your MIDI interface is correctly installed and configured. You must do this before proceeding.
- 2** Choose one pair of input/output ports on your MIDI interface to use as your sync “loop” for application-to-application MIDI communication.
- 3** Connect a MIDI cable from that port’s output to the same port’s input (for example, port 1 out to port 1 in).
- 4** In Pro Tools, select the appropriate in/out ports when making your selections for MIDI source and/or destination ports.
  - If you are slaving your sequencer to Pro Tools, select the appropriate port in the Session Setup window’s MTC to Port pop-up menu.
  - If you are slaving Pro Tools to your sequencer, select the appropriate port in the Pro Tools Peripherals > Synchronization window.
- 5** In your sequencer, select the appropriate in/out ports for MTC source/destination.

---

## Using MIDI Machine Control

Pro Tools provides the capability to transmit location information to external devices, and to control their transports, using MIDI Machine Control (MMC).

### Controlling External Devices using MMC

Any device which supports MMC (such as an Alesis ADAT or Tascam DA-88) can be controlled directly from within Pro Tools, with either the device or Pro Tools acting as clock master.

The external devices supported by Pro Tools implement “open loop” communications only. Because of this, while Pro Tools is the transport master, any direct operation of the receiving device’s transport will not be communicated back to Pro Tools. Instead, you can use the Transport pop-up to select the external device (MMC in the pop-up) and use the Pro Tools on-screen transport controls to drive the device.

Pro Tools does not support remote track arming of MMC-controlled external devices. You need to manually arm tracks for recording on the external device.

---

\* Digidesign’s MachineControl option does support remote track arming. See “Remote Track Arming” on page 353.

---

## Macintosh

Pro Tools on the Macintosh uses OMS to facilitate MIDI Machine Control. In order to use MMC with Pro Tools you must configure your MMC device as an OMS device and enable MMC as an attribute of the device in OMS. For an example of this, see “Using MMC to Sync an ADAT to Pro Tools on the Macintosh” on page 354.

\* By using the OMS IAC bus, you can also make a MIDI sequencer act as location master. Refer to your OMS and MMC-compatible device documentation for details.

## Windows

Pro Tools in Windows uses your Multimedia Setup to determine which MIDI devices are available, and what their properties are. Refer to your device’s installation and usage documentation to properly configure the device.

## Enabling MIDI Machine Control in Pro Tools

### To enable MIDI Machine Control:

- 1 Choose Setups > Peripherals, then click Synchronization.
- 2 Select your synchronization peripheral from the Synchronization/Device pop-up. If you are using a MIDI interface, select “Generic MTC Reader.”

If using a USD or SSD, set the Port to Any.

3 Select the appropriate port for synchronization information. This is the port to which your synchronization peripheral is attached.

4 Click the Machine Control button at the top of the window to open this page of the Peripherals dialog.

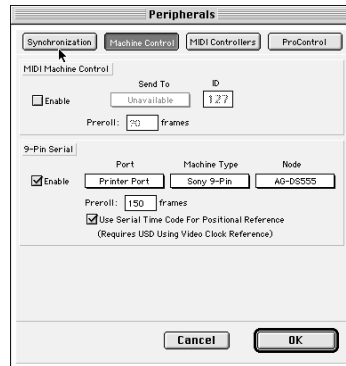

*Machine Control page of the Peripherals dialog*

5 In the MIDI Machine Control section, enable MMC.

6 Select your external device from the Send To pop-up. The list of available devices is determined by the OMS devices configured in your OMS Studio Setup (Macintosh), or by your Windows Multimedia setup.

The port on which this information will be transmitted is set in the “ID” field. MMC commands contain an ID number to identify which machine should respond to the MMC command. There are 128 MMC ID numbers, from 0-127. The default of ID #127 is a special setting that broadcasts to all 128 MMC IDs. With this setting, any device on the specified port will respond to MMC commands.

7 Set a preroll time for your MMC device. Preroll is needed to provide Pro Tools with sufficient time to lock to the incoming time code. This value will vary depending on the external device. If the preroll time is insufficient, Pro Tools may not be ready to lock until after the current time code position has passed.

8 Click OK to close the Peripherals dialog. Pro Tools will now be able to control the selected device's transport.

## Operating the Pro Tools Transport with MMC

### To control external devices from the Pro Tools Transport:

- Select either Pro Tools or MMC from the Transport pop-up in the Pro Tools Transport window. The selected item will act as Transport Master.

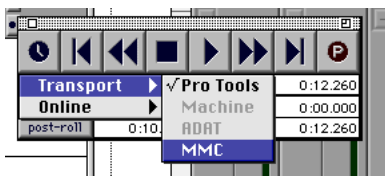

### Choosing a Transport Master

When the Transport Master is set to Pro Tools, the playback position is governed by the on-screen cursor in Pro Tools.

When the Transport Master is set to MMC, the playback position is governed by the external device's play position

## Machine Transport Settings

When using MMC, you can set the following options for machine transport behavior in the Operation page of the Preferences dialog.

**Machine Chases Memory Location** With this option enabled, navigating to a specific location in a session with a Memory Location causes a connected transport to chase to that location.

**Machine Follows Edit Insertion/Scrub** With this option enabled, navigating to a specific location in a session by moving the selection point or by scrubbing a track causes a connected transport to chase to that location.

---

## Remote Track Arming

Digidesign's MachineControl™ option for Pro Tools allows you to remotely arm tracks on supported 9-pin or V-LAN decks. Without MachineControl, Pro Tools does not support remote track arming of external devices. MachineControl is a DAE Extension which allows Pro Tools to act as the master or slave to external Sony 9-pin or V-LAN machines, in addition to providing remote track arming from within Pro Tools. Contact your Digidesign Dealer for information about the MachineControl option.

## Setting Minimum Sync Delay

Lock up delay is the amount of time your system's devices need to achieve synchronization "lock." This amount varies for each device. Pro Tools lock up delay is set by entering a value for Minimum Sync Delay in the Synchronization window of the Peripherals dialog. The minimum delay is 15 frames. Find the shortest possible lock-up time that your equipment can operate at consistently, and set this as the Minimum Sync Delay. On some machines, enabling the Use Serial time code setting will make machines lock up much faster.

### Configuring Minimum Sync Delay for External MMC Devices Locked to House Sync

When controlling a house-synced device from Pro Tools via MMC, the device will first lock to the MMC location and then align the color framing. Within house sync code are 4 frames for ensuring color frame lock. If the minimum synchronization set up time is less than the time required to achieve both location and color frame lock, playback will begin before the device has aligned the color frames. In this scenario, you should set the Minimum Sync Delay to be more than the time required for color frame lock. This is not a problem with the USD, which will drop out of lock until the color frame is locked.

## Using MMC to Sync an ADAT to Pro Tools on the Macintosh

The following section presents an example of how you can use MMC to slave an ADAT to Pro Tools on a Macintosh using OMS.

### Setup Description:

**Hardware:** Pro Tools system (Macintosh), Opcode Studio 64X MIDI Interface, JL Cooper DataMaster, Alesis ADAT.

**Software:** Pro Tools, OMS

**Cable Connections:** The Studio 64X's Mac/Serial port is connected to one of the CPU serial ports (Modem or Printer). MIDI In and MIDI OUT connections are made between the appropriate ports of the 64X and the MIDI IN/MIDI OUT ports of the JL Cooper DataMaster. Sync (9-pin) In/Out connections are made between the JL Cooper DataMaster and the ADAT.

### In OMS Setup:

- 1** Make sure the OMS IAC Driver is installed and configured. See "Syncing a Sequencer to Pro Tools on the Macintosh" on page 349 for more information.
- 2** Define a new device for the JL Cooper DataMaster and the ADAT.
- 3** Configure the JL Cooper device by double-clicking its icon in the OMS Studio Setup window. For the JL Cooper DataMaster, enable Is Controller, then enable both Sends and Receives MIDI Time Code. (Be sure to leave Is Multitimbral unchecked.) Select channel 1 as the Receive Channel.

**4** Configure the ADAT OMS device by double-clicking its icon. Leave Is Controller and Is Multitimbral unchecked (disabled). Enable both Sends and Receives MIDI Time Code and MIDI Machine Control. You do not need to have any Receive channels enabled.

**5** Save/Make Current and then close the new OMS Studio Setup.

### In Pro Tools

**6** Choose Setups > Peripherals and click Synchronization.

**7** Select Generic MTC Reader as the Synchronization device (this represents the 64X), then select the port to which your MIDI Interface is connected to (in this example, the port choice would appear as “Studio64X / Printer.”)

**8** Open the Machine Control window of the Peripherals dialog. In the MIDI Machine Control section, enable MMC, then select JLCoooper DataMaster as the Send To destination.

**9** Set the ID to 127 (this is the “broadcast to all” setting, and the Pro Tools default setting for MMC device ID).

**10** Choose Windows > Show Session Setup.

**11** In the Session Setup Window, set the frame rate and start frame as appropriate.

**12** Enable the MTC to Port option (click in the box so that it is enabled), then select JLCoooper DataMaster in the pop-up next to MTC to Port. This routes MIDI Time Code from Pro Tools to the JLCoooper. device, which then sends the data on to the ADAT.

**13** Close the Session Setup window.

**14** Click Play or press the Spacebar. The ADAT will cue to the play point and begin playing back in sync with Pro Tools. You do not need to put Pro Tools online to control the ADAT.

**15** To control the ADAT from the Pro Tools Transport, select MMC from the Transport pop-up (in the Transport window). Pressing Play, Rewind, FFWD, RTZ or Go To End will cause the ADAT to respond accordingly.

### External Hardware Configuration

This example uses the JL Cooper Data-MASTER, which must be configured correctly for the above to work. Configure the ADAT as a slave (not master), enable MTC as the sync source, and enable MIDI Machine Control. The ADAT must be set to Internal mode. Consult the documentation that came with these devices for more details. If you are using a Digidesign ADAT Bridge I/O, refer to the *ADAT Bridge I/O User's Guide* for additional information.

---

## Syncing Pro Tools to an OMS-Compatible Sequencer using MMC

### (Macintosh Only)

You can “lock” a MIDI sequencer to Pro Tools for synchronized operation, while using the *sequencer* as the transport and location master. In this case, Pro Tools is still the system clock master, while the sequencer is the transport/location master.

## MMC and OMS Synchronization

When using MIDI Machine Control, you must have the OMS-compatible sequencer configured to synchronize to Pro Tools using the OMS IAC Driver (see “Syncing a Sequencer to Pro Tools on the Macintosh” on page 349). When controlled by a sequencer via MMC, Pro Tools serves as clock master for the sequencer.

Pro Tools also serves as a transport and location slave to the sequencer. When starting and stopping playback in the sequencer, the sequencer sends out location information to Pro Tools via MMC commands. Pro Tools then cues to the location, begins playback, and sends MIDI Time Code back to the sequencer. The sequencer then locks to the MIDI Time Code from Pro Tools for synchronized playback.

The following instructions describe the general steps that you should take, using Opcode’s Vision software as an example and Pro Tools as transport and cueing slave. The exact synchronization setup your sequencer requires will vary depending on the software and your specific OMS setup.

### To slave the Pro Tools transport to an OMS-compatible MIDI sequencer using MIDI Machine Control:

- 1** Make sure the OMS IAC Driver is installed in the OMS Folder inside your System Folder. If necessary, run the OMS Installer and choose Custom Install to install the OMS IAC driver.
- 2** In Pro Tools, choose **Setups > OMS Studio Setup** to launch the OMS Setup application.

#### In OMS Setup:

- 3** Choose **Setups > Preferences**, make sure the “Use Serial DMA driver when available” option is deselected, and click **OK**.
- 4** Choose **Setups > OMS MIDI Setup**, make sure the “Run MIDI in background” option is selected, and click **OK**.
- 5** Choose **Setup > MIDI Cards and Interfaces**, and click **Update Setup**.
- 6** Select the port that the MIDI interface is connected to, then click **Search**.
- 7** Confirm that the OMS IAC driver appears in the OMS Studio Setup window. Save the setup document and make it your current setup.
- 8** In the OMS Studio Setup window, define two IAC busses by double-clicking the IAC Driver, then naming the first field “IAC1” and the second field “MMC.”

#### In Vision:

- 9** Choose **Setups > Enable Input Devices**, and select the IAC bus (“IAC1”).
- 10** Choose **Options > Sync Options**



**11** In the Sync Options dialog, set the Receive Sync Mode pop-up to MTC/Machine Control, set the Receive Sync Device pop-up to IAC1, and enable Remote Start. (Leave the Send Sync option set to None.) Also, configure the frame rate to match your Pro Tools session. Click OK to close the Sync Options dialog.

**12** Set the sequence start time (01:00:00:00 for example). The Offset at the top of the Sequence window should usually match the Offset in Pro Tools.

**13** Select Wait Note in the Transport.

**14** Click the Play button. Vision should now be ready to start synchronized playback.

### **In Pro Tools:**

**15** Choose MIDI > Enable Input Devices. Select the IAC bus transmitting the MMC messages and click OK.

**16** Choose Operations > Active in Background.

**17** Choose Windows > Show Session Setup, and choose the appropriate frame rate and SMPTE Start Frame to match the offset (start time) in Vision.

**18** In the Output Time Code section of the Session Setup Window, enable the MTC to Port option. In the pop-up menu just below the MTC to Port option, choose IAC1. You can now close the Session Setup Window, or leave it open (settings are active as soon as they are enabled in the Session Setup Window).

**19** Next, choose Setups > Peripherals, and open the Synchronization page of the Peripherals dialog.

**20** First, select Generic MTC Reader as the synchronization device, and select Any as the port.

**21** Next, click to Enable Control of Pro Tools via MMC, and set the ID to 0.

---

▲ If MMC is also currently enabled in the Pro Tools Peripherals > Machine Control dialog, you must assign a unique ID number in both of the corresponding MMC ID# fields. If not, an MMC feedback loop will occur. This can also happen if you use the default “broadcast to all” ID number of 127 in both places. If you are only slaving Pro Tools to a sequencer via MMC, without an external device requiring MMC from Pro Tools, you should disable MMC entirely in the Machine Control window.

---

### **In Vision:**

**22** Engage any of the following Transport functions in Vision: Play, Stop, Fast Forward, Rewind, Record, or Locate (Cue). Vision will send MIDI Machine Control commands to Pro Tools via the IAC bus, and Pro Tools will follow.

When starting and stopping playback in the sequencer, Vision will send out location information to Pro Tools via MIDI Machine Control commands. Pro Tools will then cue to the location, begin playback, and in turn send MIDI Time Code back to Vision. Vision will then lock to the MIDI Time Code from Pro Tools for synchronized playback.

---

## MIDI Beat Clock

Some MIDI devices such as drum machines, hardware sequencers, and arpeggiators can only sync to MIDI Beat Clock. To sync these devices to Pro Tools, you can transmit MIDI Beat Clock to them.

### To transmit MIDI Beat Clock:

- 1 Choose MIDI > MIDI Beat Clock.
- 2 In the MIDI Beat Clock dialog, select the Enable MIDI Beat Clock option.



*Beat Clock dialog*

- 3 Select the devices you want to receive MIDI Beat Clock. If your MIDI interface does not support transmitting MIDI Beat Clock to separate ports, only the interface appears as a destination.
- 4 Click OK.

---

## Spotting Regions to SMPTE Frame Locations

---

▲ Spotting to SMPTE time code is available on TDM systems only.

---

*Spotting* is the process of assigning music and sound cues to specific SMPTE frame locations in a film or video. This function can be used to spot:

- ◆ Entire regions, selected with the Grabber. Multiple regions can also be selected, and Pro Tools will reference the first region in your selection.
- ◆ A specific location within a region, by clicking with the Selector at that location, and choosing Edit > Identify Sync Point.

### Spot Mode

In Spot mode, a region in a track can be quickly spotted by simply clicking it with the Grabber.

You can also drag a region from the Regions List into a track while in Spot mode.

### The Spot Dialog

The Spot Regions Dialog appears when you drag a region to a track or click a region with the Grabber in Spot Mode. The numeric fields function as both data displays and editing controls for the currently selected regions.

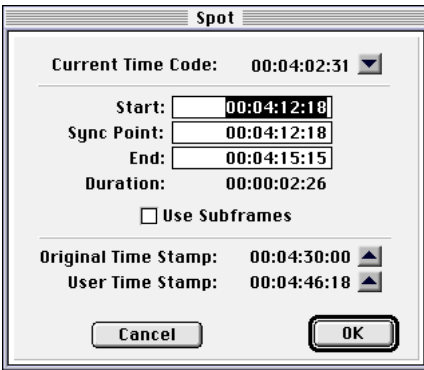

*Spot dialog*

Information in these fields is displayed in SMPTE Time Code, Minutes:Seconds, Feet.Frames, Samples, or Bars & Beats, depending on which Time Scale format is selected.

A highlighted numeric field indicates the current active field for numeric entry editing. Entering a value in a field allows you to move a selected parameter to the time location that you enter. The Start, Sync Point and End fields are accessible when the Grabber is active. Only the Start or End (depending on where you click the mouse) and Duration fields are active when the Trimmer is active (see “Using the Trimmer in Spot Mode” on page 360).

\* To increase or decrease SMPTE values in the Spot dialog by a specific number of frames, press “+” or “-” on your numeric keypad, enter a number, and press the Enter key.

### Subframes

A subframe is 1/100th of a frame. The Use Subframes option enables you to use these smaller units for greater accuracy. This command adds an additional time field in

the SMPTE hours:minutes:seconds:frames box, which appears as the far right time field when enabled. Use a period to separate subframe values from whole frames.

\* Subframe measurements are not available in the Current Time Code field.

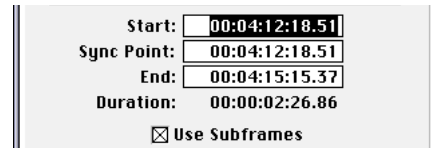

*Additional time field appears with “Use Subframes” enabled*

### Capturing Time Code

Pro Tools also allows you to easily “capture” frame locations on the fly in this dialog by pressing the “=” key, or by clicking the Current Time code button while valid time code is being received by Pro Tools. With VITC, you can accurately capture a paused or “crawling” VTR’s SMPTE location.

When SMPTE Time Code is selected for the Time Scale, pressing “=” captures the incoming time code. When Bars & Beat is selected for the Time Scale, pressing the “=” key will capture to the nearest measure.

Although the Capture Time Code button works with free-running Linear Time Code (LTC) or VITC, frame numbers of a paused frame can only be captured with VITC.

The USD is the only current Digidesign hardware that can read VITC. Also, you can use the optional MachineControl software to read the current time code address over 9-pin or V-LAN.

### To spot a region to a specific SMPTE frame:

- 1 Choose Display > Show Edit Window.
- 2 Choose Display > Time Code.
- 3 Click the Spot button at the top left of the Edit window to put Pro Tools into Spot mode.



*Spot Mode button*

- 4 Identify the SMPTE frame location where you wish to trigger playback of your region by pausing your video deck on that frame.
- 5 With the Grabber, click a region in a track (or drag a region from the Region's List into a track). The Spot dialog appears.
- 6 Enter the desired SMPTE frame location.
- 7 If you are using VITC, you can press the "=" key on your numeric keypad, or click Current Time Code to enter a paused VTR's current SMPTE location.
- 8 If you are using LTC, when SMPTE Time Code is selected for the Time Scale, press the "=" key on the numeric keypad to capture the incoming time code. When Bars & Beats is selected for the Time Scale, press the "=" key to capture to the nearest measure.
- 9 If you recorded the region while online, you can use the Original Time Stamp button to recall and enter the SMPTE frame location at which the region was originally recorded. You can also access a user-defined Time Stamp in the same fashion. See "Time Stamping" on page 133 for more information.
- 10 Click OK to close this dialog. The region spotted to the chosen SMPTE frame location. When the session is online, this frame number will trigger playback of the region.

## Auto-Spotting Regions

The Pro Tools Auto-Spot Regions option simplifies the task of spotting regions even further. If you are using VITC with this option enabled, or MachineControl software, you can pause your video at an appropriate SMPTE frame location, click on a region with the Grabber, and the region will be automatically spotted to the current time code location.

### To Auto-Spot a region:

- 1 Choose Operations > Auto-Spot Regions.
- 2 If you are using VITC, identify the SMPTE frame location where you wish to trigger playback of your region by pausing your video deck on that frame.
- 3 Click the desired region with the Grabber. The region will be automatically spotted to the current time code location (or machine location).

---

\* Clicking a region with the Trimmer will allow you to trim the region to the current time code location.

---

\* Auto-spotted regions are spotted by their start times, unless you have identified a Sync Point (see "Identifying a Sync Point" on page 362). If the region contains a Sync Point, the region is spotted to it.

---

## Using the Trimmer in Spot Mode

You can use the Spot dialog to trim your regions, including start/end/duration times and referencing incoming time code addresses. If you click a region with the Trimmer in Spot mode, the Spot dialog will appear, allowing you to enter a value in the

Start or End and Duration fields to specify exactly where you wish to trim the region's beginning or end. Use this to edit the length of a region to correspond to a particular visual "hit point."

Trimming a region which contains a Sync Point (see "Identifying a Sync Point" on page 362) will not affect the SMPTE location of the Sync Point, unless the region is trimmed past the Sync Point.

---

## Time Stamping

Pro Tools time stamps every region recorded online with the original SMPTE time at which audio was recorded. You can recall this original SMPTE time for a region by clicking the Original Time Stamp button in the Spot dialog.

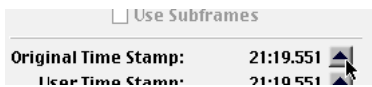

*Original Time Stamp button in the Spot dialog*

You can also spot a region to a separate user-defined SMPTE time stamp, defined using the Time Stamp Selected command. Once the region is time stamped using this command, you can click the User Time Stamp button to re-spot a region to its user-defined SMPTE location.

The Use Subframes option in the Spot dialog enables you to work with subframe accuracy by adding an additional time field in the SMPTE hours:minutes:seconds:frames box. This additional time field appears as the far right time field when enabled, and allows you to enter subframe

values in SMPTE dialogs. Use a period to separate subframe values from whole frames.

## Show Original Time Code in Regions

This command displays the original "time stamped" SMPTE times in all regions currently placed in tracks. This SMPTE frame number represents the time at which the region was originally recorded online with Pro Tools, and does not necessarily reflect the region's current SMPTE location in a track.

**To display the original time stamps in regions:**

- 1 Choose Display > Display Time in Regions > Original Time Stamp.
- 2 To hide Original Time Stamps, choose Display > Display Time in Regions > None.

## Time Stamp Selected

If you wish to create a separate user-defined SMPTE time stamp, you can use the Time Stamp Selected command in the Regions List pop-up menu. This command allows you to select a region (or regions) and re-define its SMPTE time stamp. The original time stamp and the user-defined time stamp are then stored with your session.

When audio is first recorded, the user-defined time stamp will match the original time stamp, but you can change the user-defined time stamp at any time using the Time Stamp Selected command. This feature is particularly useful in post-production situations where the SMPTE time code on video "work prints" often changes from one edit revision to another.

### To time stamp a region (or regions) with a new SMPTE frame number:

- 1 In a track, select the region that you wish to time stamp.
- 2 From the Regions List pop-up menu, choose the Time Stamp Selected command.

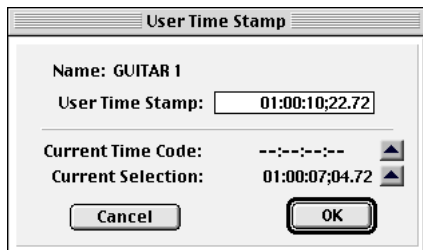

*Time Stamp Selected command*

- 3 Enter a new SMPTE time. You can do this in three ways: enter the numbers manually (with the help of the arrow keys); click the Current Time Code button (or press the = key), if you wish to capture the incoming time code address; or click the Current Selection button if you wish to enter the start time of the current on-screen selection.

- 4 Click OK to close this dialog.

This command can be used in “batch mode” to set new time stamps for several regions at a time. To do this, simply select several regions and choose the Time Stamp Selected command. One after another, a dialog will open for each region, allowing you to quickly enter new values.

Once entered, the user time stamps can be displayed in all regions currently placed in tracks.

### To display the user time stamps in regions:

- 1 Choose Display > Display Time in Regions > User Time Stamp.
- 2 To hide User Time Stamps, choose Display > Display Time in Regions > None.

### Using a Region with its Time Stamp in Another Session

Pro Tools saves time stamp information for each region as part of a session—not as part of the audio file itself. If you wish to use a time-stamped audio file in another session, keeping its time stamps intact, do the following:

- 1 Open the session that contains the original time-stamped region.
- 2 Select the desired region in the Audio Regions List.
- 3 Choose Export Selected from the Regions List pop-up menu. The region can now be used in other sessions with its original time stamp references intact.

---

## Identifying a Sync Point

The Pro Tools Identify Sync Point command allows you to identify a specific point within a region for audio spotting purposes.

Imagine the following sound effects spotting scenario: You have a single sound effect that consists of a creaky door slamming shut, followed by a few seconds of ambient reverberation. The slam portion of the effect—which you must precisely match to picture—occurs neither at the

very beginning of the audio file nor at the very end. It is somewhere in the middle, making it tough to spot.

In this scenario, use the Identify Sync Point command to create a point in the region and sync that point to a SMPTE frame.

When you choose this command, the current SMPTE time is automatically entered as the SMPTE location for the Sync Point.

#### **To create a sync point in a region:**

- 1 Click with the Selector at the point in the region that you wish to synchronize to a SMPTE frame location.
- 2 Choose Edit > Identify Sync Point. A marker appears in the audio region indicating the location of this Sync Point.

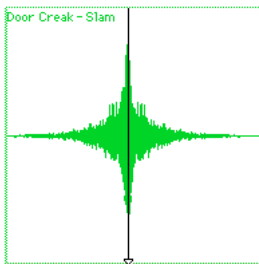

*Identifying a Sync Point in a region*

## **Changing a Sync Point**

**To change the location of a Sync point in a region:**

- Click with the Selector in the region and choose Edit > Identify Sync Point. The new location will then be identified as the Sync Point.

## **Tips for Locating and Spotting to Sync Points**

- To place a region's start point at the current edit cursor location, Control-drag (Macintosh) or Start-drag (Windows) the region from the Region List.
- To place a region's Sync point at the current edit cursor location, Option+Control-drag (Macintosh) or Alt+Start-drag a region from the Region List .
- To move to the next region boundary or sync point, press Tab.

## **Removing a Sync Point**

**To remove a Sync point from a region:**

- 1 Select the entire region with the Grabber.
- 2 Choose Edit > Remove Sync Point.

---

## **Troubleshooting Sync**

Getting SMPTE synchronization to work properly can seem like a formidable task at times. The following suggestions may help you troubleshoot and solve common problems.

### **Use the Current TC field in the Session Setup Window as a Reference**

The Current TC field in the Session Setup Window indicates whether or not Pro Tools is receiving time code. If this field appears to be inactive when inputting time code into your time code reading device, check your hardware device settings, the device's connection to your computer, and your OMS Setup (Macintosh) or Multimedia Setup (Windows).

## **Stripe SMPTE Before You Record**

All tapes in your setup (both audio and video) must be striped with SMPTE Time Code before any audio is recorded onto them or to Pro Tools. If tapes aren't striped, your system may seem to work, but synchronization will never properly occur. The machines and Pro Tools will drift farther and farther apart the longer they run.

The same problem occurs when audio is recorded into Pro Tools without a resolved SMPTE source (if it was recorded before the current session, for example.) The audio cannot be accurately synchronized with an analog tape recorder or video tape deck, since the Pro Tools audio was not recorded referenced to the SMPTE Time Code from the analog tape deck or video tape deck.

## **Resolve All Components of Your System**

When striping time code, make sure that the time code generator and the video record deck are resolved to the same crystal reference. For example, when striping 29.97 Drop Frame time code onto a VTR, both the SMPTE generator and the VTR should be resolved to the same "black burst" or house sync generator. During playback, the master deck should be resolved to "black burst" or house sync.

This convention provides compatibility for your tape between the record and playback passes, and when it's played back in other facilities on different equipment. This also means that when playing back a tape striped with time code, the playback deck should be resolved to the same sync rate as the record deck was resolved to at the time

of the striping. When you stripe an audio transport with time code, it should be "free-running" and unresolved, but should be resolved with a house sync-referenced synchronizer during playback.

## **Know the True Frame Rate on Your Work Tape**

If you get your video tapes from a production company instead of recording them yourself, be absolutely sure that they indicate the SMPTE frame rate used on the tape correctly.

The Digidesign SSD and USD (and some third-party products) can be used to determine frame rate. See "Determining SMPTE Frame Rate" on page 343.

## **29.97 FPS Non-Drop Rate Can Pose Problems**

29.97 FPS Non-Drop is a slightly slower version of 30 FPS Non-Drop time code. When used with color video, each video frame now matches up with each SMPTE frame without having to use a drop-frame coding. This makes any frame number mathematics much simpler, since no frame numbers are dropped.

Unfortunately, some hardware and software devices do not recognize 29.97 Non-Drop as a separate frame rate. For example, any standard SMPTE-to MTC-converter does not explicitly recognize it. The user must tell the convertor to expect 30 FPS Non-Drop instead. In fact, many devices that read SMPTE work acceptably by reading 29.97 Non-Drop if they are set to expect 30 FPS Non-Drop.



Any SMPTE reader that uses the time code numbers to make real-time calculations (as Pro Tools does when it tries to trigger and sync to SMPTE) also needs to know that the frame format is 29.97 and not 30 FPS. Since Pro Tools allows this choice of frame rate this does not really pose a problem. The problem exists because many users cannot readily distinguish 29.97 from 30 FPS.

More importantly, some production companies will distribute video work prints striped with 29.97 FPS but mark them as “30 FPS NTSC,” by which they actually mean 29.97 FPS Non-Drop. By the time you get the tape, you may have no idea what’s actually on it. Feeding 29.97 Non-Drop to Pro Tools when it’s set for 30 FPS Non-Drop will result in timing errors of about 1.8 frames per minute, causing audio playback to trigger out of sync.

### **Be Careful When Changing Frame Rates**

If you change time code rates in the middle of a session, many SMPTE-to-MIDI Time Code converters need to be turned off and turned on again to be able to recognize the new frame rate.

### **Use a Consistent Clock Source**

A sound file should be played back using the same peripheral and sample rate it was recorded with, if at all possible. This assures the closest match between record and playback sample rates. For example, if an audio file was recorded at 44.1 kHz with the Pro Tools Audio Interface then the Sample Rate should be set to 44.1 kHz during playback with the Audio Interface as well.

### **On a Macintosh, Disable AppleTalk, Network Connections, Screen Savers, and Power Saving Features**

These types of software can cause the Macintosh to ignore MIDI data (such as MIDI Time Code) coming into its serial ports. Make sure AppleTalk is inactive in the Chooser, disconnect AppleTalk cables, and remove any INIT-based network software from your System Folder.

### **On a Windows Computer, Disable Screen Savers and Power Management Features**

These types of software can cause your computer to ignore MIDI data (such as MIDI Time Code).



## chapter 25

# Working with QuickTime Movies

You can use Pro Tools to import QuickTime™ movies and audio, perform audio post-production tasks, and export the finished product as a new QuickTime movie.

▲ QuickTime™ movie features in Pro Tools are supported on Macintosh systems only.

## About QuickTime

QuickTime is digital video technology designed to produce compact video files for multimedia use.

## Using QuickTime Movies in Pro Tools

Pro Tools allows you to import QuickTime™ movies into your Pro Tools sessions.

Once imported into Pro Tools, a QuickTime movie is displayed in its own Movie track in the Edit window, and in a floating Movie window. This floating window can be viewed on a second monitor with appropriate video hardware. With a QuickTime movie in the session, Pro Tools serves as a

fast, random-access visual reference for “sweetening” the movie by adding sound effects, music, Foley, dialog, or other audio.



*Movie Track displayed as picons*

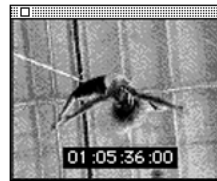

*Movie Window*

Pro Tools provides precise, frame-accurate audio and video synchronization. This means you can use your Pro Tools system as an off-line audio editing system, leaving the video editing suite free for video editing.

With Pro Tools, you can:

- ◆ import a QuickTime movie into a session.
- ◆ import audio from a QuickTime movie (or audio from a CD or a CD-ROM).

- ◆ synchronize audio events to a QuickTime movie, using the Pro Tools editing features to spot and nudge regions to video frames.
- ◆ scrub audio elements in tandem with a QuickTime movie.
- ◆ use the Pro Tools Bounce to Movie command to compile a new “flattened” QuickTime movie file that can be read by any QuickTime-compatible application.

Because Pro Tools has no video editing capabilities of its own, if you wish to edit or in any other way modify a movie, return to your video capture/assembly environment (for example, Adobe Premiere) for editing, then import the edited movie into Pro Tools.

---

\* You can capture (but not edit) Avid-compatible video in Pro Tools with AVoption .

---

## Video Capture/Playback Cards

For professional applications where full-screen, 25/30 frames-per-second playback is critical, we recommend that you invest in a Digidesign-approved third-party video capture and playback card. For the most up-to-date information about such products, contact your Digidesign dealer or visit Digidesign’s website.

## If You Are New to Audio Post Production

If you are new to digital video, time code, or audio-for-post production, the following suggestions will help you manage your session’s audio/video requirements. Not all of these may apply to every project.

**Plan ahead** Think through your entire project before you start capturing your video. For best results when working with SMPTE time code, make sure that time code is burned into a window in the movie. Try to anticipate compatibility and configuration issues that may arise.

**Conform Your Movie** Be sure to conform your captured QuickTime movie to the desired frame rate. Consult your video capture software’s documentation for information on how to ensure frame-accurate captures. We recommend that you do this to all video captures to ensure accurate playback in Pro Tools.

**Destined for video or film?** What is the ultimate destination of your work? Is it for TV, film, audio CD or CD-ROM? This will determine such things as the best sample rate to use, the correct frame rate, pull-down or pull-up rates, and so on. Double-check the time code frame rate. You must make absolutely sure that you know the correct frame rate of the video source.

**Storage** Make sure you have enough disk space on your drive, and optimize your hard drive(s) regularly.

**Video compatibility** If you are not digitizing the video material yourself (if the material is already on hard disk) check into the type of video capture/playback system that was used and make sure you can accommodate that format’s compression method. Check whether or not time code is “burned into” or superimposed over a small area of the video.

---

## QuickTime Requirements

Pro Tools supports playback of QuickTime videos without additional hardware. However, performance will vary in terms of maximum movie size, frame-rate, and smoothness of playback. Capture of 30/25 FPS (frames per second), 60/50 fields-per-second video requires a Digidesign-approved video capture card, and associated software and hardware.

### About Frame Length and QuickTime Movies

Not all video capture software can guarantee consistent frame lengths. Consult your video capture software documentation for information on ensuring frame-accurate captures, and on conforming your video to proper frame boundaries.

To take advantage of Pro Tools QuickTime movie playback capabilities you will need the following:

- ◆ The most recent version of Apple's QuickTime System Extension (included with Pro Tools). To install QuickTime, run the Custom Install option in the Pro Tools installer.
- ◆ Apple's QuickTime PowerPlug system extension, if you are using a Power Macintosh.
- ◆ QuickTime movie playback and editing software (such as Adobe Premiere, AVID VideoShop, Macromedia Director, or Apple MoviePlayer) to edit and compile QuickTime movies.

Optionally, you may also need:

- ◆ QuickTime movie capture hardware and software to digitize your own movies from a videotape or video camera source.
- ◆ An Apple CD-ROM drive running at 2x speed or faster to take advantage of commercially-available QuickTime movies and sound clips.

---

## Movie Playback Quality Options

Pro Tools supports three options for movie playback performance: Normal Priority Playback, Medium Priority Playback, and Highest Priority Playback. In most cases, you should leave the priority choice set to Normal Priority Playback. If you are running QuickTime Movies *natively*, that is, without a capture card, you may need to use one of the other playback priority options. If this does not apply to you, leave movie playback priority set to Normal Priority Playback. This is the default setting.

### Hard Drive Tips for Best Performance

For best movie playback performance, make sure that the hard drive you are using for video capture and playback is not on the same SCSI bus as your audio files, if possible. This allows the least amount of interference between drives when Pro Tools requests audio and video data. With most capture cards, and moderate data capture rates (800 kilobytes per second or less), this should provide good performance.

Blue & White G3 Macintosh computers have an internal IDE system drive. Audio and video should be stored on SCSI drives, connected to the computer with a Digidesign-approved SCSI interface card.

Some recent Macintosh computers have two SCSI busses, an internal SCSI bus, and a separate external SCSI bus. The internal bus is often a SCSI Fast-compatible bus which can yield better disk performance. The external bus is a narrow SCSI bus, which is slower. For best performance use an internal drive which connects to the internal fast SCSI bus.

For G3 Macintosh models that have only a single, narrow SCSI bus, you should use a SCSI accelerator for the audio drive, and use the narrow bus for QuickTime video.

Contact your Digidesign dealer or visit the Digidesign website for compatibility information.

---

## Importing a QuickTime Movie

Before you import a movie, you should digitize your video material and know the correct frame rate and sample rate when applicable.

▲ If a video card with video compression was used to create the QuickTime movie, Pro Tools cannot play the movie without the compression hardware. Make sure the video card is installed and configured correctly before starting your session.

---

### To import a QuickTime movie into Pro Tools:

- 1 Launch Pro Tools and create a new session, or open an existing one.
- 2 Check the time code parameters of the session to make sure they match those of the movie you wish to import, and save the session.
- 3 Choose Movie > Import Movie.
- 4 Locate the desired movie. When you select a movie in the Import Movie dialog, you can view a preview frame by enabling the Show Preview check box. The preview corresponds to the first frame of the movie. If you have not yet created a preview, you can do so by selecting the desired movie and clicking Update in this dialog.

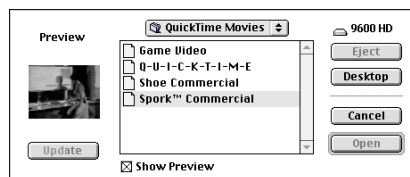

*Import Movie dialog*

- 5 Select the desired movie and click Open. Pro Tools imports the movie and displays it in its own Movie track in the Edit window as well as in a floating Movie window. The first frame of the movie is automatically synchronized to the start time of your session.

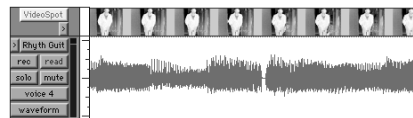

*The movie track "VideoSpot" appears above the "Rhythm Guitar" track*

## About the Movie Track

Once a movie is imported into Pro Tools it appears in the Edit Window in its own Movie Track. This picon (picture-icon) track displays a “thumbnail” overview of the frames of the movie it represents. The Movie track will show greater or lesser detail depending on your current zoom level in the Edit window — the closer in you zoom, the greater the number of individual frames that are displayed in the Movie track; the farther out you zoom, the fewer the number of individual frames that are visible. The Movie track appears only in the Edit window.

The Movie track behaves much as a Pro Tools audio or MIDI track in that you can move the Movie region with the Grabber or other editing tools. This allows you to offset the movie to any start point. However, you cannot edit the Movie track by trimming it or capturing regions from within it.

Only one QuickTime movie can be associated with a session at a time. If you wish to import a different movie into a session, repeat the previous steps. The new movie will replace the original in the session.

A Movie Track takes its name from its associated Movie file and cannot be independently renamed.

## Scrubbing the Movie Track

You can use the Audio Scrubber tool to scrub the Movie track with full frame accuracy. If you scrub directly on the Movie track, only the movie will scrub (no audio will play). If you scrub on an audio track, audio and the movie will scrub simultaneously.



*Scrubbing a movie*

### To scrub the movie track:

- 1 Select the Audio Scrubber.
- 2 Click the movie track at the desired point and drag the Scrubber.
- 3 To scrub with finer precision, hold down the Command key while scrubbing.

## About the Movie Window

The Movie window displays the movie playback or the current frame if playback is paused or stopped. You can drag the Movie window anywhere on your computer screen.



*Movie window*

### To display the Movie window:

Choose **Movie > Show Movie Window**. If a movie has already been imported, the Movie window will appear.

## Using a 14-inch monitor for playback

If you capture 320 x 240 (NTSC) movies and have a second monitor with 640 x 480 resolution (a standard 14-inch monitor), clicking on the Movie window will route movie playback to that monitor. The Movie will “bounce” over to the second monitor, and will be pixel-doubled so that it takes up the whole screen.

## Tips for Optimizing Movie Playback

Since Pro Tools uses Apple’s QuickTime technology to play movies, the quality of the playback is dependent on the speed of your Macintosh CPU and hard drive, the size (in pixels) of the movie, and the quality of the video hardware used to capture and playback the digitized video. While QuickTime doesn’t produce broadcast-quality playback, it is frame accurate when spotting to picture.

On PCI-based computers, Pro Tools continuously re-syncs the movie. The movie resolves to the audio sample clock. This allows the movie to smoothly track the audio even when your system is varispeeded.

For more consistently smooth movie playback, here are some suggestions:

- ◆ Use a Digidesign-approved video capture/playback card for 25/30 frames-per-second full-screen movie playback.
- ◆ Display the movie on a separate monitor driven by a video capture/playback card.
- ◆ If you don’t have a video capture/playback card, set the movie playback priority to Medium Priority Playback or High Priority Playback using one of these commands

in Movie menu. This gives priority to movie playback, rather than other screen graphics tasks such as moving faders.

- ◆ Use the fastest CPU possible.
- ◆ Capture and play QuickTime video from a separate hard drive other than your Pro Tools audio drive(s).
- ◆ Remove unneeded System software Extensions and Control Panel items.
- ◆ Disable AppleTalk and other background tasks on the CPU, such as File Sharing, screen savers, Calculate Folder Size and any fax or electronic mail software.
- ◆ Disable Moving Faders During Playback in the Automation Preferences.
- ◆ Set No Auto Scrolling in Operations > Scroll Options.
- ◆ Reduce the size of the Edit window to the smallest possible size.
- ◆ Close unnecessary windows.
- ◆ Reduce the overall length of the SCSI chain of your computer system for improved throughput.
- ◆ Reduce the pixel size of the movie (e.g. reduce it from 640 x 480 pixels to 320 x 240 pixels).

---

## Setting the Movie Start Time: Movie Offset

When you import a movie into your session, the first frame of the movie defaults to the start time of your session. In some cases, however, you may need to offset the movie by some amount forwards or backwards so that you can accurately spot audio to the movie.



Since a movie can be moved inside the Movie track, it is fairly easy to match these two times. In fact, you may not have to move the Movie track at all.

For finer adjustment of a movie's start time, you can use the Set Movie Sync Offset command to offset your movie in 1/4-frame increments. This is more accurate than dragging the movie track, and is especially useful in cases where your movie track happens to begin with a partial frame.

#### **To set the movie start time:**

- 1** Double-check that your session's SMPTE frame rate matches that of your movie.
- 2** If you haven't already done so, set the Pro Tools Time Scale to SMPTE time code by choosing Display > Time Code.
- 3** In the Edit Window, enable Grid mode.
- 4** Set the Grid resolution to frames by selecting frames from the Nudge/Grid pop-up.
- 5** With the Selector, click in the Movie Track to place the cursor where you wish to create a Sync Point. Often, the best spot will be the "2 beep" two seconds before the first action frame (the start of the video). You can use the plus and minus keys on your computer keyboard to nudge the cursor and the Movie one frame at a time.
- 6** Choose Edit > Identify Sync Point to place a Sync Point at the current cursor location.
- 7** Put Pro Tools into Spot mode by clicking the Spot button in the Edit window.
- 8** Click on the Movie track with the Grabber. The Move Region To dialog appears.

**9** Enter the time code number displayed in the window-burn of the frame you are spotting to (if your movie has a SMPTE time code window burned into it) and click OK to close the Move Region To dialog.

**10** The movie's sync point moves to the SMPTE location you entered.

**11** To fine-tune the movie start time, choose Movie > Set Movie Sync Offset, enter the desired offset value, and click OK.

**12** Lock the movie in place by choosing Edit > Lock/Unlock Region.

---

## **Spotting Audio to a QuickTime Movie**

For accurate spotting, Grid Mode provides you with an effective tool for quick and accurate selection of waveforms, and alignment of regions in tracks. When Grid Mode is enabled, the Selector will snap to the currently selected grid mode value, and regions selected with the Grabber and dragged onto a track will also line up with the selected value.

### **Conforming Your Movie**

Before you spot audio to a movie, you should conform the movie file so each frame starts and ends at valid frame boundaries.

For example, Adobe Premiere contains a Conform Movie tool for destructively editing the lengths of each frame to the grid of the current frame rate. You should conform the movie to a frame rate that Pro Tools can work with (30 FPS or 29.97 FPS).

Consult your video capture software documentation for more information.

### **More Tips for Spotting Audio**

- ◆ Specify your Movie size up front. For purposes of spotting audio, 320 x 240 is usually adequate. If you are displaying the movie on a 2nd monitor with 640 x 480 resolution, with pixel doubling, it will fill the screen.
- ◆ Try to work with a window burn in your Movie, since it will help you spot material. You can produce your own window burns for your capture using Digidesign's Universal Slave Driver.
- ◆ Use a continuous scrolling option. Pro Tools includes two scrolling options that are particularly useful in post-production: Continuous Scroll During Playback, and Continuous Scroll with Playhead. Enable either of these scrolling options by selecting them from the Operations > Scroll Options submenu. For more information, see *Chapter 14: Playing/Selecting Track Material*.

### **Using Grid Mode to Spot and Nudge Regions with Frame Accuracy**

Grid Mode allows you to constrain the movement of regions so that they snap to SMPTE-based measurements (minutes, seconds, frames, or subframes).

#### **To spot audio to a movie:**

- 1** Make sure no regions are selected on screen, and click the Grid button at the upper left corner of the Edit window. This ensures that your audio will be always be aligned to a frame boundary.
- 2** Set your Grid to Time Code using the pop-up menu.
- 3** Choose a desirable Grid unit setting. Note that you can set your Grid units independently of your Main Time display.
- 4** Using the Selector, place the insertion cursor at the desired location in the movie. If you wish, use the Nudge Units pop-up to set the nudge units to frames. You can then use the plus and minus keys on your computer keyboard to nudge the insertion point frame by frame.
- 5** Hold down the Control key and drag the desired region from the Regions List to the appropriate track. Pro Tools will automatically spot the region to the same time location as the cursor.

---

▲ To spot your elements directly to locations in the movie, use the technique described above. In this scenario, Auto Spot mode is not recommended, since it uses incoming MTC for location information.

---

---

### **Importing QuickTime Audio**

Pro Tools allows you to import audio directly from a QuickTime movie. You can import audio from a movie currently loaded into a session, or from a different movie. The procedure is the same for both.

## Sample Rate Conversion Quality

If you import QuickTime audio that was not originally recorded at your session's current sample rate, the sample rate is converted to match the audio to your session. Pro Tools allows you to choose the quality of the sample rate conversion via the Conversion Quality parameter in the Editing Preferences. The higher the quality of sample rate conversion that you choose, the longer it takes to perform the sample rate conversion.

The five conversion settings range from "Low" to "Tweak-head." The Low setting provides results that are considerably better than the Macintosh's built-in sample rate conversion. For most applications, the Better setting will yield excellent results.

Because the Best and Tweak-head settings take significantly longer than the others, we recommend that you use these only in cases where the highest fidelity is absolutely essential and you have a considerable amount of time. The Tweak-head setting in particular can take several hours to perform sample rate conversion on moderate-length files.

### To set the sample rate conversion quality:

- 1 Choose Setups > Preferences and click Editing.
- 2 Click the Conversion Quality pop-up menu and choose the desired setting.

## Importing Audio from a QuickTime Movie

This procedure allows you to use the Import Audio From Current Movie and Import Audio From Other Movie commands to import audio tracks either from a QuickTime movie currently imported into your session or from other QuickTime movies on your hard disk. You can also use the Import Audio From Other Movie command to import audio files of a different bit resolution or sample rate into your session.

### To import audio tracks from a QuickTime movie:

- 1 If you wish to import audio from a QuickTime movie that is already in your session, choose Movie > Import Audio From Current Movie.  
– or –
- 2 If you wish to import audio from a QuickTime movie that is not imported into your session, choose Movie > Import Audio From Other Movie. Select the QuickTime movie from which you wish to import audio. The Track Import dialog appears, listing information about the audio tracks.

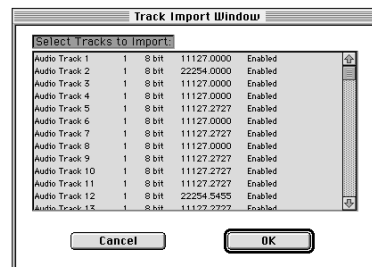

Track Import Window showing audio tracks in a QuickTime movie

**3** Select the desired audio tracks by clicking them. To select multiple tracks contiguously in this dialog, Shift-click them. To select discontinuous tracks, Command-click them.

**4** Click OK. The audio is converted to your session's sample rate setting and bit resolution, and a new region appears in the Audio Regions List for each imported file (2 regions appear for each imported stereo file). The regions are listed in the Audio Regions List with the region name, the number of the originating track, and the number of the region from the track.

**5** Drag the imported regions from the Audio Regions List into the desired track(s).

---

## Bouncing to a new Movie

When you have finished your final mix and synchronized your audio events to the movie, you can use the Pro Tools Bounce to Movie command to compile a new QuickTime movie with your bounced audio embedded in the QuickTime movie file as the soundtrack. As a QuickTime file, the new movie is supported by all software applications that support QuickTime video.

### To create a new QuickTime movie with bounced audio embedded as the soundtrack:

**1** Adjust track output levels and finalize your mix. Any Inserts and/or effects settings that are active on your tracks will be permanently written to the bounced track(s). If you don't wish to apply a Plug-In Insert to the bounce, click the Bypass button in the Inserts/Sends Editor window.

**2** Make sure that all of the tracks you wish to include in the bounce are audible (not muted).

**3** Assign the output of each of the tracks you wish to include in your bounce to the same output pair.

**4** If you wish to bounce the entire session, press the Return to Zero button on the Transport to go to the beginning of the session. The new movie file will include all the video and audio material in the session, even if the duration of the video material is longer than the audio or vice versa. If you only wish to bounce a portion of a session, open the Edit window and select the section that you wish to include in the bounce.

**5** Choose **Movie > Bounce to Movie**.

**6** Select the file format for your movie audio. Choose Mono to combine the left and right channel output of your session into a mono movie soundtrack. Choose Stereo to retain the stereo mix of your session for the movie audio.

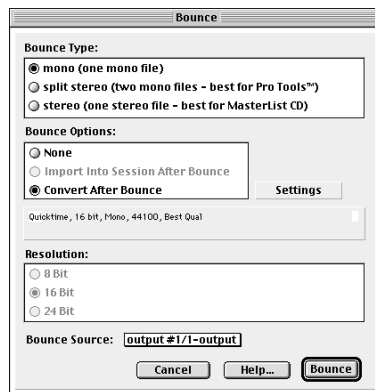

**Bounce Tracks dialog**

**7** Select the resolution for your movie audio. Red Book audio CDs are always 16-bit, while many multimedia presentations and CD-ROMs use 8-bit resolution. You cannot create a QuickTime movie with 24-bit audio; audio from 24-bit sessions is converted to 16-bit or 8-bit audio, depending on what you choose.

**8** If you intend to convert your session to 8-bit resolution for use in multimedia, use the Squeezer option (click the Convert after Bounce option, then the Settings button to access this feature) to improve the fidelity of the converted 8-bit audio. This option uses a proprietary DSP algorithm that preprocesses the audio using compression, limiting and gating before converting to 8-bit resolution. We recommend this option for optimal results.

**9** Select the Sample Rate for your movie audio (click the Convert after Bounce option, then the Settings button to access this parameter). The default audio sample rate is 44100 (44.1kHz) which is the standard sample rate for audio CDs. Multimedia presentations and CD-ROMs may use a sample rate of 11025 (11.025kHz) or 22050 (22.050kHz).

**10** Click Bounce, name the new movie, and choose where to save it.

**11** The audio tracks are converted to the selected sample rate and bit resolution, and a new flattened movie is created incorporating the audio. You can open and play the flattened movie in any software application that supports QuickTime.

---

\* Pro Tools sample rate and bit resolution conversions use large amounts of processing power. Save time by selecting a lower sample rate conversion quality in the Editing Preferences.

---



# DSP-Induced Delays in Mixing

In all digital systems, signal processing incurs signal delays of varying amounts. These delays can vary from as short as several microseconds to as long as several milliseconds, depending on the type of processing being performed.

## Delay Factors

In Pro Tools, delay is incurred when you perform the following processes:

### Bouncing Tracks

**Bus-based bounces** When you bus a track to another track and record the result, the following delays are incurred:

*Bus-based bounce delays for each Pro Tools system*

Pro Tools Hardware	Delay
Pro Tools 24	8 samples
Pro Tools 24 MIX	10 samples

**Bounce to Disk** The File > Bounce To Disk command causes no delay on a TDM-equipped system since delay compensation for the bounce function is built in. This form of bouncing may be more desirable than bus-based bouncing.

### Use of Inserts & Sends

The following delays are incurred when you add an Insert or Send to a track:

- Insert: 2 samples
- Post-fader Send: 6 samples
- Pre-fader Send: 3 samples

### Use of Hardware Inserts

When an Audio Interface peripheral is used on an Insert, there are two sources of delay: the samples incurred in using an Insert, and a delay introduced by going through the D/A and A/D converter pair (for analog devices) or digital I/O connection (for digital devices) on the Audio Interface.

On the 888/24 I/O, the Digital I/O delay incurred when using AES/EBU or S/PDIF is identical.

#### Audio Interface Delay Characteristics

Interface	A/D/A delay	Digital I/O
888/24 I/O	81 samples	17 samples
882/20 I/O	75 samples	17 samples
1622 I/O	75 samples	17 samples

---

## Compensating for Delays

If you wish to compensate for offsets incurred by these delays, there are two different methods you can use: apply sample-level delay to tracks with the TimeAdjuster Plug-In, or physically adjust tracks in the Edit window by the appropriate number of samples.

### Using the TimeAdjuster Plug-In

You can use the TimeAdjuster TDM Plug-In provided with your Pro Tools system to apply an exact number of samples of delay to the signal path of the tracks you are working with. Up to 2048 samples of delay are available.

Digidesign TDM Plug-Ins display their delay values in the channel delay indicators in the Mix window. TimeAdjuster can be used to match these delay values for tracks that need to remain in phase (such as instruments recorded with multiple microphones or stereo pairs).

In the Mix window, Command-click (Macintosh) or Control-click (Windows) the Track Level Indicator to toggle between Level (which appears on the display as “vol”), Peak (“pk”) and Channel Delay (“dly”) indications. Delay values are shown in samples.

### To use TimeAdjuster to compensate for a time delay:

**1** Apply the TimeAdjuster Plug-In to the track whose delay you want to increase, and Command-click (Macintosh) or Control-click (Windows) its Track Level indicator until the Channel Delay value is displayed for that track.

**2** Change the delay time in TimeAdjuster by moving the Delay slider or entering a value in the Delay field, until the channel delay value matches that of the first track.

You can test the delay values by duplicating an audio track and reversing its phase while compensating for delay.

If you are using a Plug-In whose delay factor are you not familiar with, you can set the delay by ear using one of two methods:

- ◆ If you are working with phase-coherent track pairs, or tracks that had been multi-miked, you can “null out” the delay. Invert the phase of the target track using the TimeAdjuster Phase Invert button, and adjust the Plug-In delay time until the signal disappears. (When they are perfectly synchronized, duplicate signals of opposite polarity cancel each other out.) When you are finished, disengage the Phase Invert button.

- ◆ You can also change the delay while listening to the signal in phase, adjusting until any comb-filter effects cancel out.



## Nudging Audio Tracks

On audio tracks, you can use the Pro Tools Nudge feature, which supports single-sample increments, to nudge the affected regions to preserve phase coherency. If it is necessary to nudge a region by a large number of samples, you may want to calculate the equivalent value in milliseconds and nudge the Region in millisecond increments. If the value doesn't divide evenly, you can switch the Nudge value back to samples and use these smaller increments for the remainder.

The disadvantage of using this method is that it only works with disk tracks (not live inputs), and the timing relationship between tracks is permanently altered, which can affect editing.

### Sample Rate and How it Affects Delay

The delay in samples caused by TDM processing is the same regardless of the sample rate because a sample is tied to the rate of the sample clock for the entire system. However, when samples are converted into a time value (milliseconds or microseconds), the sample rate (44.1 versus 48 kHz) must be taken into account.

**To convert from samples to milliseconds (and vice-versa) use this formula:**

- milliseconds = samples / sample rate (in kHz)
- samples = milliseconds X sample rate (in kHz)

There are 44 samples per millisecond @ 44.1 kHz, and 48 samples/ms. @ 48 kHz.

---

\* There are actually 44.1 samples/ms at 44.1 kHz, so Pro Tools rounds down to 44 samples/ms. One time in ten, Pro Tools rounds off to 45 samples/ms. At 48 kHz, no rounding occurs.

---

Here's an example of how to compensate for a delay:

Imagine that you have used a hardware insert on the 888/24 I/O. According to the guidelines given previously, the total amount of delay introduced is:

Insert = 2 samples

888/24 I/O A/D/A = 79 samples

Total = 81 samples

If you are working at 44.1 kHz, set Nudge/Grid to milliseconds and nudge the region backwards (earlier in time) 2 ms (2 x 44 = 88 samples). Then set Nudge/Grid to samples, and nudge it forward (later in time) 7 samples for a total of 81 samples.

---

## Typical Delay Scenarios

Below are some typical delay scenarios that you may encounter in a Pro Tools session. The more complex a session becomes, the greater the TDM delay factors may become.

Once you know the delay for your session, set the Nudge Value to that amount (in samples) and nudge the affected regions to compensate for the delay.

### Example 1, Pro Tools 24 System

A bus-based TDM bounce with no Plug-Ins adds 8 samples of delay:

- ◆ Track 1 routed to Bus 1-2, with pan set <100 = 2 samples
- ◆ Through Bus 1-2 Mixer and back out to TDM = 3 samples
- ◆ Record to Track 2 with input set to Bus 1 = 3 samples

**Total: 8 samples**

### Example 2, Pro Tools 24 System

A slightly different bounce adds 11 samples of delay because it involves use of a Send:

- Track 1/Send 1 (post-fader) routed to Bus 1 = 5 samples
- Through Bus 1-2 Mixer and back out to TDM = 3 samples
- Record to Track 2 with input set to Bus 1 = 3 samples

**Total: 11 samples**

### Example 3, Pro Tools 24 MIX System

A bus-based TDM bounce with no Plug-Ins adds 10 samples of delay:

- ◆ Track 1 routed to Bus 1-2, with pan set <100 = 2 samples
- ◆ Through Bus 1-2 Mixer and back out to TDM = 5 samples
- ◆ Record to Track 2 with input set to Bus 1 = 3 samples

**Total: 10 samples**

### Example 2, Pro Tools 24 MIX System

A slightly different bounce adds 14 samples of delay because it involves use of a Send:

- ◆ Track 1/Send 1 (post-fader) routed to Bus 1 = 6 samples
- ◆ Through Bus 1-2 Mixer and back out to TDM = 5 samples
- ◆ Record to Track 2 with input set to Bus 1 = 3 samples

**Total: 14 samples**

# TDM Mixing and DSP Usage

---

## Pro Tools TDM Technology

### (TDM Systems Only)

Digidesign's TDM (or *time division multiplexing*) technology is based on the concept of a single, high-speed data highway, or *bus*. In Pro Tools 24 MIX/MIXplus, Pro Tools 24 and Pro Tools III systems, individual channels from sources such as disk tracks, sends, or busses are sent out from Digidesign audio cards, and combined together or *multiplexed* onto the TDM bus. At the receiving end, the audio cards can listen to any connection on the bus, and take whatever data they need.

With Pro Tools 24 MIX/MIXplus, Pro Tools 24 or Pro Tools III systems, you can choose how to allocate the processing power of your system. In most cases, you'll start the allocation process by configuring your mixer, then assigning Plug-In effects according to how much remaining processing power you have.

---

## DSP Allocation

### (TDM Systems Only)

Digital Signal Processing (or DSP) capability is one of the most powerful elements of your Pro Tools 24 MIX/MIXplus, Pro Tools 24 or Pro Tools III system. The DSP chips in your system provide the real-time processing power for your TDM Mixer and Plug-Ins. There is a limit, depending on your system, to how many functions a single DSP chip can power at once. This section contains some guidelines for getting the most from your available DSP capacity.

## DSP Allocation Basics

As in the analog world, every send bus or output mix that you use demands that a summing mixer exist for that group. On an analog console, the number of these summing mixers is fixed by the physical layout of the console. In the Pro Tools mix environment, this number is variable, and depends on the number of output mixes or sends that you choose to create. Pro Tools allocates DSP power as it is needed to build the mixers for each session.

We refer to certain mixing or signal processing functions as “using one DSP” or “using two DSPs.” This refers to the fact that there are a certain number of DSP chips on a card (six on a MIX card, or four on a DSP Farm card), each of which can only power a certain number of processing functions. If you have a single MIX card or DSP Farm card, and you create a big enough TDM mixer and use enough Sends or Plug-Ins, you will eventually use up or “max out” all DSPs and will be at your limit for mixing and processing (unless you add more cards to your system).

## Mixing and DSP Usage

Pro Tools builds a TDM mixer every time a session is opened. Note that the term “mixer channel” applies to Audio tracks (including virtual tracks) and Auxiliary Input tracks, as well as sends and returns that use any of the 32 TDM internal busses. When you go beyond a certain number of mixer channels, Pro Tools will use another DSP to create additional mixer capacity.

With Pro Tools 24 and Pro Tools III systems, Pro Tools does not always automatically free up all unused DSP power when you delete unneeded mixer channel. On these systems, to reclaim all DSP power after a change in your session configuration, close your session and reopen it. Pro Tools will rebuild your new mixer configuration to use DSP power with maximum efficiency.

## DSP Manager

### (Pro Tools 24 MIX/MIXplus Systems Only)

Pro Tools software (version 4.3 and higher) includes *DSP Manager*, a software component that optimizes the use of DSP capacity on Pro Tools 24 MIX/MIXplus systems.

When you have a MIX card in your system, if your current DSP usage is approaching the capacity of the card, and you then try to add a mixer channel or instantiate a Plug-In, the DSP Manager will automatically try to make room for the new mixer or Plug-In on the MIX card. It does this by re-allocating the existing TDM mixers and Plug-Ins to use the available DSP capacity on the MIX card as efficiently as possible.

## Monitoring DSP Usage

To monitor the usage of DSP resources during a Pro Tools session, choose Windows > Show DSP Usage.

To display DSP resources in different formats, choose Display > DSP Usage Window Shows and choose a format from the Display menu.

As you allocate DSP to mixing or processing with Plug-Ins, the DSP Usage window indicates when DSP chips are available and when they are in use. Green indicates a chip is free. Red indicates a chip is in use.

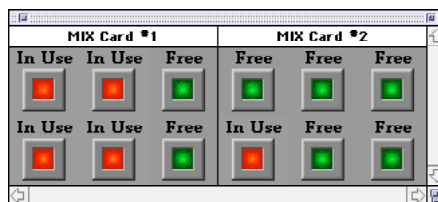

DSP Usage window showing Large format

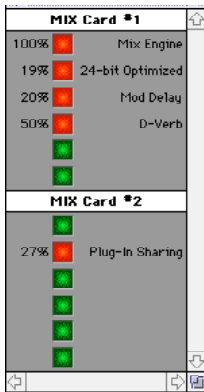

**DSP Usage window showing Detailed format**

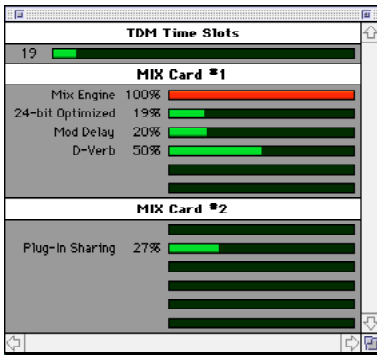

**DSP Usage Window showing Gas Meter format**

The Detailed and Gas Meter formats show the percentage of each DSP chip in use.

With these indicators as your guide, you can try different mixer setups and different arrangements of Plug-Ins, Sends, and Auxiliary Inputs to maximize your use of available DSP power.

## Setting up Sessions to use DSP Efficiently

The dynamically configurable mixing environment in Pro Tools lets you make choices based on the type of setup you wish to have—such as how many inputs you want for your mixer, how many Plug-Ins you want to use, or how many sends you need.

For example, you could allocate all of your DSP power to create a large mixer with dozens of channels—but you wouldn't be able to use as many busses, sends, or TDM Plug-Ins. Alternatively, you could create a mixer with a smaller number of mixer channels plus some Sends and Auxiliary Inputs for returns, and TDM Plug-Ins on several tracks.

---

\* *AudioSuite* Plug-Ins do not use DSP and are always available. Refer to your *DigiRack Plug-Ins Guide* for more information.

---

You can set up your session by choosing one of the session templates supplied with your system as a starting point, or by building it from scratch. If you are starting from scratch, a good rule of thumb is to start by building your mixer first, since at least one of the DSPs in your system is automatically dedicated to mixing. Start with Audio tracks, then add Sends and Auxiliary Inputs, and finally add Plug-Ins as available DSP allows. Master Faders do not use additional DSP power.

---

## DSP Usage with TDM Mixers

### Understanding Mixers

DSP allocation for mixing in a Pro Tools TDM system is based on the concept of DSP summing mixers. Every send bus or output mix that you use demands that a summing mixer exist for that group. Each pair of outputs or busses that you use requires its own mixer.

An “input” can be a disk track, a send, or an internal bus connection. Adding a pair of outputs or busses adds the requirement for more DSP power.

A MIX card has six DSP chips, and a DSP Farm card has four DSP chips, each of which can power a certain number of signal processing tasks. DSP resources are dynamically allocated as the number of mixers and/or inputs increases.

The TDM mixer provides basic building blocks by which applications such as Pro Tools can create a wide variety of mixer configurations. Each TDM mixer is of the dimensions “N x 2,” meaning that it mixes a variable number of inputs to an output pair.

For example: a session with 6 tracks routed to output 1–2 would require a single 6 x 2 mixer. If one of the tracks is assigned to output 3–4, however, 2 mixers are required—one 5x2 mixer routed to output 1–2, and one 1x2 mixer routed to output 3–4.

The important concept here is that every pair of outputs (whether they are I/O or bus outputs) requires that a mixer exists for that output pair. This means that creating a send to bus 1 requires that a mixer be created for the bus 1-2 outputs, and that mixer will have one input.

### Types of Mixers

Pro Tools offers two different mixer plugins: a “24-bit optimized” mixer and a “16-bit optimized” mixer. These mixer modules use DSP power at slightly different rates on DSP Farms, but at the same rate on MIX cards, as shown below:

#### DSP Farm:

16-bit Optimized mixer: 36x2 per chip

24-bit Optimized mixer: 25x2 per chip

#### MIX Card:

16-bit Optimized mixer: 59x2 per chip

24-bit Optimized mixer: 59x2 per chip

If the DSP is also being used for I/O processing, then some of the chip’s capacity will be devoted to I/O, yielding slightly lower mixer count (these figures represent maximum numbers when I/O is declared in the Hardware Setup dialog):

#### DSP Farm with one I/O declared:

16-bit Optimized mixer: 30x2 per chip

24-bit Optimized mixer: 20x2 per chip

#### MIX card with one I/O declared:

16-bit Optimized mixer: 51x2 per chip

24-bit Optimized mixer: 51x2 per chip

**MIX card with two I/Os declared:**

16-bit Optimized mixer: 43x2 per chip

24-bit Optimized mixer: 43x2 per chip

**Submixing**

When there is no space remaining on any DSP for a single mixer to increase the number of inputs, summing mixers must be created. For example, on a Pro Tools 24 system, when a 24-bit Optimized mixer needs to grow to more than 26 inputs, a summing mixer is created along with another 1 x 2 mixer to handle the 27th input. Both the original 26 x 2 mixer and the new 1 x 2 mixer are routed to the new summing mixer, whose outputs go to the desired destination (such as output 1-2).

Keep in mind that any delays inherent in creating the summing mixer are equal. Since input signals are delayed equally, phase coherency is preserved.

The number of virtual tracks supported by your particular Pro Tools configuration will ultimately determine the maximum number of channels for your TDM mixer.

**Sends, Busses, and Master Faders**

Each send will add an input to the destination output pair. For example, a send to output 1 will add another input to the output 1–2 mixer. If the send destination doesn't already have a mixer for its output pair, then a new mixer will be created. A send to bus 3 will make a 1x2 mixer for bus 3–4 if no other bus 3–4 sources have been created yet.

In addition, adding a new track and assigning its input to a bus source will create a mixer for that bus pair if there isn't one already. For example, creating a new Auxiliary Input track and setting its input to bus 5 will create a 1x2 mixer for bus 5–6, even if no sources have been created yet.

**Mixing Guidelines**

The following conditions apply to mixing with Pro Tools 24 MIX/MIXplus, Pro Tools 24 and Pro Tools III systems. One DSP chip is automatically dedicated to mixing in the TDM environment.

- ◆ As you reach the basic mixer limits for a single DSP chip, the system will automatically begin allocating DSP resources from another chip (if available), making it unavailable for Plug-Ins.
- ◆ Each bus or send connection requires DSP to mix signals. This means that each Send or Auxiliary Input that you create will use available DSP.
- ◆ On Pro Tools 24 systems, the 16-bit Optimized Mixer can power more channels per DSP chip than the 24-bit Optimized Mixer Plug-In. There may be cases where using the 16-bit Optimized mixer will help conserve enough DSP power to allow for additional Plug-Ins.

On Pro Tools 24 MIX/MIXplus systems, there is no advantage to using the 16-bit Optimized mixer, so you should always use the 24-bit Optimized mixer.

---

## DSP Usage with TDM Plug-Ins

Some basic guidelines for DSP usage on Pro Tools systems follow:

- ◆ TDM-equipped systems running Pro Tools 4.3 or higher software use DigiDesign's MultiShell technology, which allows any MultiShell compatible Plug-In to share DSP chips on both MIX cards and DSP Farm cards. Up to five types of MultiShell compatible Plug-Ins can share a single DSP chip.

---

☞ Refer to the *DigiRack Plug-Ins Guide* for details on MultiShell Plug-In counts.

---

- ◆ Stereo DSP Plug-Ins generally use up twice as much DSP as mono Plug-Ins.
- ◆ Master Faders don't require additional DSP. Use them freely to control submix levels, send/bus output levels, and the master output level of your session.

The session templates provided with your system include several useful preconfigured session setups that make efficient use of DSP resources.

If your computer has unused slots, you can always increase your available DSP resources by adding additional MIX Farm or DSP Farm cards to your system.

---

## DSP Usage and I/O Allocation

On TDM-equipped Pro Tools systems with a single Audio Interface, at least one DSP chip on your MIX card (Pro Tools 24 MIX

or MIXplus systems) or DSP Farm (Pro Tools 24 or Pro Tools III systems) is automatically allocated to mixing and input/output tasks.

Even though this is only a small portion of the DSP power available on the chip, it effectively dedicates the entire chip to mixing tasks, making it unavailable for Plug-Ins.

If you have an additional Audio Interface assigned to a DSP Farm or MIX Farm card, Pro Tools will use a DSP chip *on that card* for mixing and I/O tasks as well.

If you are not currently using your additional interface, you can free up DSP and use it for additional Plug-Ins.

### To reallocate I/O capacity on a DSP Farm or MIX Farm card:

- 3 Choose Setups > Playback Engine.
- 4 From the Card pop-up menu, select the MIX Farm or DSP Farm whose DSP you want to reallocate.
- 5 From the Interface pop-up, select No Interface.
- 6 Click OK to close this dialog. When the session reopens, the DSP that was allocated to I/O is available for mixing or Plug-Ins.

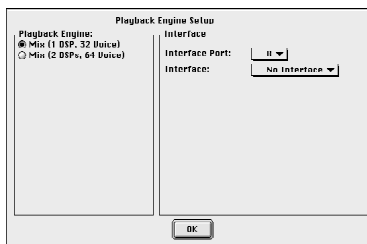

Reallocating I/O in the Playback Engine dialog



## appendix c

# Keyboard Shortcuts

## Global Key Commands

This section shows keyboard shortcuts that apply to many functions in Pro Tools.

### Channel Strip/Track functions

- Changing automation mode
- Enabling playlists
- Adding Plug-Ins
- Record enabling, soloing, muting tracks
- Assigning Inputs, Outputs, and Sends
- Toggling volume/peak delay display
- Clearing meters
- Changing track heights

Command	Macintosh	Windows
Apply action to all channel strips/tracks	Option + action	Alt + action
Apply action to selected channel strips/tracks	Option-Shift + action	Alt-Shift + action

### List and Parameter selection

- Selection of tracks in Show/Hide List
- Enabling of groups in Groups List
- Automation Enable window parameters
- Setting memory location parameters

Command	Macintosh	Windows
Toggle item & set all others to same new state	Option-click item	Alt-click item
Toggle item & set all others to opposite state	Command-click item	Control-click item

### Controls and Editing Tools

- ◆ Use to move Plug-In controls, faders and sliders, the Scrubber, and automation data

Command	Macintosh	Windows
Fine adjustment of sliders, knobs & breakpoints	Command-click item	Control-click item

---

## Commands Key Focus

### (TDM Systems Only)

The Commands Key Focus provides a wide range of single-key commands from the alpha keyboard for controlling editing and playback.

Pro Tools TDM systems include a set of keyboard stickers that show the single-key commands and other modifier keys.

#### To enable the Commands Key Focus:

- Click the a-z button in upper left of the Edit window.



Commands  
Key focus

#### Commands Key focus enabled

You can temporarily invoke single-key commands even when Commands Key focus is not enabled by pressing Control (Macintosh) or the Start key (Windows) while pressing the appropriate key.

---

☞ Refer to the Quick Reference Card that came with your Pro Tools package (TDM systems only) for a complete list of keyboard shortcuts. This card is also available in PDF format in the Release Notes and Documentation folder.

---

---

## Numeric Keypad Modes

The Operation preference for Numeric Keypad Mode determines how the numeric keypad functions.

No matter which Numeric Keypad Mode is selected, you can always use the numeric keypad to select and enter values in the Event Edit Area, Location Indicators, and Transport fields.

#### To set the Numeric Keypad Mode:

- 1 Choose Setups > Preferences and click Operation.
- 2 Under the option for Numeric Keypad Mode, select one of the following modes, then click Done.

### Classic

This mode represents how Pro Tools has always worked in versions earlier than 5.0. With the Numeric Keypad Mode set to Classic, you can:

- Play up to two tracks of audio in Shuttle Lock mode. Press Control (Macintosh) or the Start key (Windows), followed by 0-9 for different play speeds. Press Plus or Minus to reverse direction.
- Recall Memory Locations by typing the Memory Location number, followed by period.

## Transport

This mode allows you to set a number of record and play functions, and also operate the Transport from the numeric keypad.

Function	Key
Click on/off	7
Countoff on/off	8
MIDI Merge/Replace mode	9
Loop Playback mode on/off	4
Loop Record mode on/off	5
QuickPunch mode on/off	6
Rewind	1
Fast Forward	2
Record	3
Play/Stop	0

With the Numeric Keypad Mode set to Transport, you can also:

- Play up to two tracks of audio in Shuttle Lock mode. Press Control (Macintosh) or the Start key (Windows), followed by 0-9 for different play speeds. Press Plus or Minus to reverse direction.
- Recall Memory Locations by typing period, the Memory Location number, and period again.

## Shuttle

### (TDM Systems Only)

Pro Tools offers another form of shuttling, different from that of Shuttle Lock Mode. With the Numeric Keypad Mode set to Shuttle, playback is triggered by pressing and holding the keys on the numeric keypad—playback stops once the keys are released. Various playback speeds are available in both forward and reverse.

Function	Key
1 X Forward	6
1 X Rewind	4
4 X Forward	9
4 X Rewind	7
1/4 X Forward	3
1/4 X Rewind	1
1/2 X Forward	5+6
1/2 X Rewind	5+4
2 X Forward	8+9
2 X Rewind	8+7
1/16 X Forward	2+3
1/16 X Rewind	2+1
Loop Selection	0

With the Numeric Keypad Mode set to Shuttle, you can also:

- Recall Memory Locations by typing period, the Memory Location number, and period again.

---

▲ Shuttle Lock mode is not available when the Numeric Keypad Mode is set to Shuttle.

---



# Troubleshooting

---

## Backing up your work

It is highly recommended that you back up your work on a regular basis, and especially before making changes to your system configuration.

### Back up your session data

Back up your session and audio data frequently. There are a variety of media that are suited to back up projects of various sizes, from automated tape backup systems to high-capacity optical drives, to desktop CD-R burners.

The best way to back up a session is to use the Save Session Copy In command to save the session file and all of its associated files to a new location.

### Back up your system setup

**Macintosh** Back up your System Folder before upgrading your OS.

**Windows** Create a system recovery disk *after* you have finished configuring your system and installing software. This is more useful than a recovery disk for an unconfigured system.

---

## Common Issues

### Pro Tools software won't authorize

(Macintosh TDM Systems)

#### Problem:

You are unable to authorize Pro Tools TDM software on a Macintosh Blue & White G3 using the authorization key disk.

#### Possible Solution:

◆ Check to be sure you have the latest versions of the Imation floppy disk drivers and the Pace Floppy Enabler, which are required for authorization of Pro Tools TDM Software on Blue & White G3 computers. The latest versions of these drivers are automatically installed on applicable Macintosh models by the Pro Tools Installer.

If the disk drivers and enabler are not installed in the proper location, use your Pro Tools Installer disc to install them.

## Pro Tools won't launch

### Problem:

When you double-click the Pro Tools application or a Pro Tools session file, Pro Tools doesn't launch.

### Possible Solutions:

- ◆ (TDM systems only) Turn off your computer and check to be sure your cables are properly and securely connected to the correct Pro Tools cards and to your Audio Interfaces.
- ◆ (Digi 001 systems only) Turn off your computer and check to be sure your cable is properly and securely connected to the Digi 001 PCI card and to the Digi 001 I/O Box.
- ◆ Turn off your computer and check all Pro Tools cards installed in your computer to be sure they are properly seated in their PCI slots, and that any TDM ribbon cables are connected properly.
- ◆ Verify that Pro Tools cards are installed in the correct slot order in your computer or Expansion Chassis.
- ◆ Check to be sure your computer has the required amount of RAM to launch Pro Tools.
- ◆ (Macintosh Only) Verify that the DAE application is installed in the proper location. It should be in the DAE Folder inside your System Folder. If DAE is not installed in the proper location, use your Pro Tools Installer disc to install it.

- ◆ (Macintosh Only) Verify that the DigiSystem INIT is installed in the Extensions folder, inside the System Folder. If it is not, use your Pro Tools Installer disc to install it.

- ◆ (Macintosh Only) Verify that Virtual Memory is turned off. On the Macintosh, open the Memory Control Panel. If Virtual Memory is turned on, turn it off and restart your computer.

### Problem:

You get an error message when you try to start the Pro Tools application.

### Possible Solutions:

- ◆ (Macintosh) Make sure the default set of Mac OS System Extensions is enabled, along with the OMS, DigiSystem Init, and DSP Manager Extensions.
- ◆ Try a complete restart. (Turn off your Audio Interfaces, computer peripherals and your computer, and then turn them on again in the proper sequence.)
- ◆ Use the DigiTest application (installed in the Pro Tools Utilities folder) as a diagnostic tool to verify that your Digidesign cards are operational. You need to restart your computer before and after using the DigiTest utility.

## **Audio Interface isn't recognized**

**(TDM Systems Only)**

### **Problem:**

When you launch Pro Tools it does not recognize an Audio Interface, or a connected Audio Interface is not available.

### **Possible Solutions:**

- ◆ Turn off your computer and check to be sure your cables are properly and securely connected to the correct Pro Tools cards and to your Audio Interfaces.
- ◆ Verify that your Hardware Setup is correct; check to see that you have selected the correct Interfaces for each I/O card.
- ◆ If you only have one interface, make sure it is connected to the Disk I/O card (Pro Tools III), d24 card (Pro Tools 24), or MIX Core card (Pro Tools 24 MIX).
- ◆ Make sure SuperClock connections to your Audio Interface are correct. Disconnect the SuperClock source from the interface and see if the problem persists.

## **Audio drive doesn't appear on the Desktop**

**(Pro Tools III Systems Only)**

### **Problem:**

With a Pro Tools III system, the Pro Tools audio drive doesn't appear on your Desktop when you start your Macintosh.

### **Possible Solutions:**

- ◆ Turn off your computer and check to be sure your cables are properly and securely connected to the Disk I/O card and to the hard drive.
- ◆ Check the hard drive for proper termination.
- ◆ Make sure that the Mt. Digi Scan Time is set to its highest setting.
- ◆ Be sure to turn on the hard drive and let it come up to speed before you turn on your Macintosh. Allow at least ten seconds for the drive to come up to speed.
- ◆ Verify that Virtual Memory is turned off. Open the Memory Control Panel. If Virtual Memory is turned on, turn it off and restart your computer.
- ◆ Check that the drive is initialized for Macintosh. If it is not, disconnect the drive from the Pro Tools Disk I/O, connect it to a Macintosh SCSI port, and initialize it with the formatting software included with your system. (If the drive appears on the Desktop as soon as you connect it to the Macintosh SCSI port, then it is already initialized for Macintosh.)
- ◆ Verify that the SCSI ID of the drive is set to an ID number less than 7.

---

## Using DigiTest As a Diagnostic Tool

The DigiTest utility performs diagnostic tests on the Pro Tools cards in your system.

### To use DigiTest:

- 1 Refer to the DigiTest ReadMe file for the latest operational information.
- 2 Restart your computer.
- 3 Turn down any audio outputs on your system.
- 4 Locate and open DigiTest.
- 5 Click the Run button.

DigiTest will run a diagnostic test on your Pro Tools cards. When the test has been completed, the Status field will indicate whether each card has passed or failed.

6 If DigiTest reports that any of your cards have failed, click the Info button next to that card. Write down the information that appears and report it to your local Digidesign dealer or a Digidesign Technical Support Representative.

---

## Performance Factors

There are several conditions that may adversely affect the performance of Pro Tools. These include:

**Network Connections** Close any network connections unless you are using them for network interchange of audio data.

**Background Applications** Any software utilities that run in the background or generate disk activity, such as virus protection software, disk optimizers, or file savers, should be turned off or removed.

**Screen Savers** Screen saver software should be completely removed from your computer before running Pro Tools.

**Power Saver Features** Some automatic power saver features, such as those that spin down the system hard drive, can affect Pro Tools performance. These features should be turned off.

**Virtual Memory** (Macintosh Only)  
Pro Tools will not launch if Virtual Memory is active. Deactivate Virtual Memory and restart your Macintosh.

**CD-ROM Extensions/Control Panels** Some CD-ROM and removable media Extensions and Control Panels have been linked to audio quality problems. Deactivate any performance-enhancing Extension or Control Panels for such media, and restart your computer.



---

## Before You Call Digidesign Technical Support

### Register your System

As a registered owner of a new Digidesign product under warranty, you are eligible to receive Digidesign Technical Support. Fill out and sign your Registration Form and mail or fax it to the address supplied with the registration materials.

Refer to the registration materials that came with your system for details on warranty coverage and the range of services available.

### Use Digidesign Resources

In addition to the Pro Tools Guides, your system includes following sources of information:

**ReadMe files** These contain late-breaking information and known issues pertaining to Pro Tools software and hardware configurations. ReadMe files are installed in the *Release Notes and Documentation* folder when you install Pro Tools.

**Answerbase** This is a database of common problems and DAE errors, and their solutions based on the latest information from Digidesign Technical Support. This database is installed in the Digidesign folder when you install Pro Tools.

**Website** The Digidesign website includes an area for Technical Support, as well as a User Conference that includes technical discussions. Visit [www.digidesign.com](http://www.digidesign.com) and go to the Support area or the User Conference area.

## Gather Important Information

Digidesign wants to help you resolve problems as quickly and efficiently as possible. If you have the following information handy when you contact Technical Support, it will make the diagnosis of your problem easier. Take a few minutes to collect this basic information in one place.

### System Information

#### Computer

- ◆ Make, Model, processor speed
- ◆ Amount of system RAM
- ◆ Operating system (version of Mac OS or Windows)
- ◆ Any Drivers, Extensions, Control Panels, Disk Utilities, or other system-related applications you may have installed.

#### Digidesign Hardware

- ◆ Type of cards, interfaces, or peripherals
- ◆ Where the cards are installed
- ◆ PCI card order in computer or chassis
- ◆ Interfaces connected to each card

#### Hard Drives

- ◆ Make, Model
- ◆ Speed (RPM)
- ◆ Type of SCSI Connection (narrow, wide)

#### Digidesign Software

- ◆ Pro Tools software version
- ◆ (Macintosh) DAE and DSI versions
- ◆ Plug-In versions
- ◆ Other Digidesign software
- ◆ Additional Plug-Ins from Digidesign Development Partners

### ***Other Hardware***

If you are using additional hardware, refer to the manufacturer's documentation for operational details.

The most common hardware additions include the following:

- ◆ SCSI Accelerators (manufacturer, model, settings)
- ◆ Expansion Chassis (manufacturer, model, bridge chip type)
- ◆ Video Capture cards (manufacturer, model)

Refer to Digidesign's compatibility documents or contact your Digidesign dealer to verify that the hardware has been qualified for use with your Pro Tools system.

### ***Other Software***

If you are using other audio or video applications, refer to the manufacturer's documentation for operational details.

Make note of any other software that were running when a problem occurred.

## **Diagnostic Information**

### ***DigiTest***

If you ran DigiTest on your system and it generated any errors, be sure to make a note of any error codes or messages.

### ***Other Information***

Note any DAE errors or other error codes you encounter. Also make a note of the ability to reproduce the problem under different conditions, such as with another session, or after changing settings such as the DAE Preferred Memory Size (Macintosh) or the Hardware Buffer Size (Pro Tools LE).

# index

## Numerics

- 11025 sample rate 320
- 11127 sample rate 320
- 16-bit Optimized Mixer 283
  - clipping 284
  - for 24-bit recording 284
- 22050 sample rate 320
- 22254 sample rate 320
- 24 FPS 333
- 24-bit Optimized Mixer 283
  - clipping 284
- 25 FPS (EBU) 333
- 29.97 FPS Drop 333
- 29.97 FPS Non-Drop 333, 364
- 3:2 Pulldown 334
- 30 FPS Drop 333
- 30 FPS Non-Drop 332
- 44100 sample rate 320
- 48000 sample rate 320

## A

- ADAT, syncing to 354
- adding
  - a new playlist 142
  - audio tracks 87
  - Auxiliary Input tracks 274
  - Inserts 269
  - Master Fader tracks 276
  - MIDI tracks 105
  - Sends 271
  - tracks 51
- AIFF file format 315
- All Notes Off command 225

- all tracks
  - hiding 53
  - selecting 168
  - selecting all regions in 163
  - selecting in Timebase Rulers 168
  - showing 53
- allocating
  - DSP 383, 385
  - I/O capacity 388
  - voices 14
- Audio CD Import Options dialog (Macintosh) 126
- Audio During Fast Forward/Rewind option 156
- audio files 10
  - batch loading with drag & drop 125
  - compacting 199
  - default names 78
  - formats 315
  - importing 119
  - locating 67
  - naming 69
- audio interfaces 5, 6
  - input channels 11
  - Other Options 40, 41
- audio regions 137
  - and automation 139
  - fitting to an Edit selection 260
  - stripping silence from 256
  - whole-file 134
- Audio Regions List 32, 143
  - displaying file info for audio regions 143
  - dragging from 178
  - finding regions 145
  - sorting 144
- Audio Regions List Key focus 36, 144

- Audio Regions List menu 32, 361
  - Auto Rename Selected command 197
  - Clear Selected command 198
  - Compact Selected command 199
  - Convert and Import Audio command
    - Macintosh 121
    - Windows 124
  - Display All command 145
  - Export Region Definitions command 128
  - Export Selected As Files command 127
  - Find command 145
  - Import Audio command (Macintosh) 121
  - Rename Selected command 197
  - Selected Unused command 198
  - Show Disk Names option 143
  - Show File Names option 143
  - Show Full Pathnames option 143
  - Sorting option 144
  - Time Stamp Selected command 185
- audio tracks
  - and tempo changes 229
  - bouncing to disk 313
  - channel strips 16
  - configuring for recording 87
  - creating a tempo map for 230
  - loop recording 93
  - punch recording 92
  - recording multiple 89
  - Waveform view 25, 134, 137
- Audiomedia III 7
  - QuickPunch 115
- AudioSuite Plug-Ins 263
- auditioning
  - fades 247
  - pre/post-roll 170
  - programs 210
  - selection start/end points 170
  - takes 94
- Auto Input Monitoring option 75
- Auto Region Fade In/Out Length option 255
- Auto Rename Selected command 197
- auto-created regions 134
  - hiding 198
  - renaming 196
- auto-fades 254
- AutoMatch Indicators 293
- AutoMatch Time option 292, 293
- automating
  - Plug-Ins 296
  - Sends 295
  - switched controls 295
- automation
  - and audio regions 139
  - breakpoints 302
  - buffer size 311
  - capture & apply 310
  - cutting, copying, and pasting 304
  - deleting 298
  - drawing with Pencil 300
  - editing 301
  - editing with Smart Tool 30
  - enabling, suspending 297
  - for grouped tracks 303
  - playlists 142, 287, 293
  - smoothing 292
  - snapshot 308
  - special Paste mode 306
  - stepped 302
  - thinning 293, 299
  - Trim mode 289
  - trimming 307
  - writing 294
- Automation Enable window 297
  - System/CPU/PCI Load 311
- Automation Mode Selector 19
- automation modes
  - Auto Latch 289
  - Auto Off 288
  - Auto Read 289
  - Auto Touch 289
  - Auto Write 289
  - Trim/Auto Latch 290
  - Trim/Auto Off 290
  - Trim/Auto Read 290
  - Trim/Auto Touch 290
  - Trim/Auto Write 291
- Automation Preferences
  - AutoMatch Time option 292, 293
  - Degree Of Thinning option 292
  - Memory for Automation Recording option 311
  - Moving Faders During Playback option 291
  - Mutes Follow Mix Groups 291
  - Mutes Follow Mix Groups option 60

- Smooth and Thin Data After Pass option 292, 299
- Solos Follow Mix Groups option 60, 292
- Touch Timeout option 292
- Auto-Name Memory Locations While Playing option 238
- Auto-Name Separated Regions option 176
- auto-naming
  - and Strip Silence 257
  - audio files and regions 78
  - QuickPunch regions 116
  - separated regions 176
  - takes 78
  - tracks 78
- Auto-Spot Regions command 360
- Auxiliary Inputs 273, 281
  - adding 274
  - and DSP usage 387
- Auxiliary Returns 274
- Auxiliary Send level, and Master Fader 281

## **B**

- bank select 13, 208
- Bar|Beat Markers
  - and tempo events 232
  - audio with varying tempos 231
  - editing 232
  - moving 232
- Bars:Beats Time Scale 150
- Batch Fades dialog 255
- Bi-Phase/Tach 332
- bit depth, for session 44, 340
- black burst 364
- Blocks view 135
- Bounce to Disk command 314
  - Bounce dialog 314
  - Output Options 315
- Bounce to Movie command 376
- bouncing
  - printing effects to disk 282
  - to a stereo mix 323
  - to a submix 322
  - to QuickTime movies 376
- breakpoints 302
- Buffer Size 76

## **C**

- Calculator mode for numeric entry 167
- Calibration Mode 74
- cancelling record takes 88, 107
- Capture Region command 175
- capturing time code 359
- CDs, importing audio from 125
- centered crossfade 246
- Change Duration command 221
  - Change Duration window 221
- Change Meter command 233
  - Change Meter window 233
- Change Tempo command 227
  - Change Tempo window 228
- Change Velocity command 219
  - Change Velocity window 219
- Channel Delay Indicator 21
- channel strips 11
  - audio tracks 16
  - MIDI tracks 18
- chasing
  - controller events 223
  - MIDI notes 223
  - program changes 224
- Classic, Numeric Keypad mode 390
- Clear command 191
- Clear Selected command 198
- click 35
  - configuring 84
  - enabling 83
- Click Options command 84
  - Click/Countoff Options dialog 84
- clicks and pops, avoiding 138
- clipping 73
  - and 16-bit Optimized Mixer 284
  - and 24-bit Optimized Mixer 284
  - input sum levels 285
- Close Session command 50
- Color Code options 62
- Commands Key focus 36, 390
- Commands Key Focus button 26
- Comments View 23
- Compact Selected command 199
- comping related takes 95
- Compress/Expand Edit To Play command 260
- Conductor button 35

- Conductor Rulers 149
    - including in selections 168
  - configuring
    - click options 84
    - MMC 352
    - Pull Up/Down 345
    - SMPTÉ 343
  - conforming QuickTime movies 373
  - connecting
    - effects units 278
    - external audio devices 277
    - external clock sources 279
  - Consolidate Selection command 196
  - Continuous Scroll During Playback option 158
    - and half-screen 158
  - Continuous Scroll with Playhead option 158
    - and half-screen 158
  - control surfaces (see MIDI control surfaces)
  - controller events 13, 207
    - and MIDI regions 141
    - chasing 223
    - editing 208
    - editing with Smart Tool 30
    - inserting 208
  - Conversion Quality option 126, 321, 375
    - Tweak-head setting 321
  - Convert and Import Audio command
    - Macintosh 121
    - Windows 124
  - Convert and Import Audio dialog
    - Macintosh 122
    - Windows 123
  - Copy command 191
  - Copy Edit Selection to Timeline command 173
  - Copy Timeline Selection to Edit command 173
  - Copy To Send command 273, 296
    - Copy To Send dialog 296
  - copying
    - all automation playlists for a track 193
    - MIDI notes with the Split command 214
    - selections and regions 191
    - track automation to Sends 295
    - track control settings to Sends 273
  - countoff 35, 83
  - CPU Load 311
  - Create Fades command 252
    - creating
      - crossfades 251
      - fade-ins/outs 253
      - groups 65
      - Markers and Memory Locations 237
      - regions 175
      - sessions 42
  - Crossfade Preference for Pre/Post-Roll option 251
  - crossfades 245
    - creating with Smart Tool 30
    - equal gain 249
    - equal power 249, 251
    - Fades dialog 246
    - in batches 255
    - linear 251
    - overlap 251
    - pre/post 252
    - removing 252
    - trimming 252
    - types 245
    - with dither 249
  - Current Cursor Display
    - location 32
    - value 32
  - current meter 35, 233
  - current tempo 35, 227
  - custom sample rates 320
  - Cut command 191
  - cutting
    - automation 304
    - MIDI notes with the Split command 214
    - selections and regions 191
- D**
- DAC Muting option 40
  - DAE 9
    - Playback Buffer size 41
  - DAT recorder, recording from 117
  - default meter 84
  - Default Note On Velocity option 201
  - Default Program button 21
  - default program change 209
  - default tempo 85, 230
  - default track names 78
  - Degree Of Thinning option 292
  - delays (see DSP delays)
  - Delete Fades command 252

- Delete Selected Groups command 64
- Delete Selected Tracks command 52
- deleting
  - automation 298, 304
  - groups 65
  - Memory Locations 241
  - MIDI notes 206
  - playlists 142
  - program changes 210
  - sysex events 211
  - tracks 52
  - underlying region data 192
  - unused regions 198
- destructive editing
  - compacting audio files 199
- Destructive Record mode 81, 90
- destructive recording 90
- Digi 001 7
  - punching with footswitch 108, 113
  - QuickPunch 115
- Digidesign Audio Engine (see DAE)
- digital clipping 73
- digital mastering 323
- digital signal processing (see DSP)
- DigiTest 394
  - as a diagnostic tool 396
- discontiguous selections 163
- disk allocation
  - and cross-platform sessions 79
  - and system volume 80
- Disk Allocation command 79
  - Disk Allocation dialog 79
- Display All command 145
- Display Auto-Created Regions option 198
- Display Format 25, 134
  - Blocks view 135
  - Notes view 135, 139
  - Regions view 135, 140
  - Sys Ex view 211
  - Velocity view 205
  - Waveform view 25, 134, 137
- Display menu
  - Display Auto-Created Regions option 198
  - Display Name In Regions option 137
  - Display Time In Regions option 137
  - DSP Usage Window Shows option 384
  - Edit Window Shows option 23
  - Mix Window Shows option 15
  - Narrow Mix Window option 61
  - Ruler View Shows option 150
  - Sends View Shows option 271
- Display Name In Regions option 137
- Display Preferences
  - Color Code options 62
  - Draw Grids in Edit Window option 146
  - Draw Waveforms Rectified option 137
  - Peak Hold options 22
  - Show Meters in Sends View option 273
- Display Time In Regions option 137
- displaying
  - all regions 145
  - all Rulers 150
  - file info for audio regions 143
  - Meter Ruler 233
  - Original Time Stamps 361
  - region names 137
  - region times 137
  - Sends View 271
  - Tempo Ruler 227
  - User Time Stamps 362
- dithering
  - for fades/crossfades 249
  - on Master Faders 321
- Draw Grids in Edit Window option 146
- Draw Waveforms Rectified option 137
- drum machine style loop recording 109
- DSP 383
  - allocating 383, 385
  - and Auxiliary Inputs 387
  - and I/O capacity 388
  - and Master Faders 388
  - and mixing 384, 386
  - and Sends 387
  - and TDM Plug-Ins 388
  - monitoring usage 384
  - reclaiming DSP capacity 384
- DSP delays 379
  - compensating for 380
- DSP Manager 384
- DSP Usage window 384
- DSP Usage Window Shows option 384
- Duplicate command 194
- duplicating
  - MIDI note selections 194
  - playlists 142
  - selections and regions 194

- durations, for MIDI notes
  - editing with Change Duration command 221
  - making more legato 222
  - making more staccato 222
  - randomizing 221
- dynamic voice allocation 55

## E

- Edit and Timeline selections, unlinked 161
- edit commands 190
  - and Edit mode 191
  - clear 191
  - cut 191
  - paste 192
- edit cursor 155
  - and scrubbing 159
  - moving to region boundaries 169
- Edit Groups 32
  - and selections 162
- Edit Groups list 32
- Edit Insertion Follows Scrub/Shuttle option 159
- Edit insertion point
  - placing regions at 178
  - trimming regions to 181
- Edit Markers 162
  - and selection length 165
- Edit menu 230
  - Capture Region command 175
  - Clear command 191
  - Compress/Expand Edit To Play command 260
  - Consolidate Selection command 196
  - Copy command 191
  - Copy To Send command 273, 296
  - Create Fades command 252
  - Cut command 191
  - Delete Fades command 252
  - Duplicate command 194
  - Fade To End command 254
  - Fade To Start command 254
  - Heal Separation command 177
  - Identify Silence command 256
  - Identify Sync Point command 183, 363
  - Insert Silence command 258
  - Lock/Unlock Regions command 189
  - Merge Paste command 195
  - Mute/Unmute Region command 190
  - Paste command 192
  - Quantize Regions command 189

- Remove Sync Point command 183
- Repeat command 194
- Repeat Paste To Fill Selection command 260
- Select All command 163
- Separate Region command 175
- Shift command 188
- Strip Silence command 256
- Thin Automation command 299
- Trim Automation command 311
- Trim End To Insertion command 182
- Trim Start To Insertion command 182
- Trim To Selection command 177
- Write Automation command 308, 310

- Edit mode buttons 145

- Edit modes 145
  - and edit commands 191
  - and placing regions 178
  - Grid 26, 146
  - Shuffle 26, 145
  - Slip 26, 146
  - Spot 26, 146, 358

- edit playlists 141

- Edit selections
  - auditioning with Playhead enabled 173
  - copied from Timeline selection 173
  - copied to Timeline selection 173
  - sliding in the Ruler 169
  - start, end, and length fields 31

- Edit tools 27

- Edit window 24
  - Edit tools 27
  - half-screen 158
  - scrolling from the Ruler 157
  - track controls 23

- Edit Window Shows option 23

- editing

- across multiple tracks 193
- and Edit modes 145
- automation 301
- Bar|Beat Markers 232
- breakpoints 302
- controller events 208
- during playback 133
- Grid mode 146
- Markers 240
- Memory Locations 240
- meter events 234
- MIDI notes 202
- MIDI regions 140



- nondestructive 133
- non-destructively for audio 139
- non-destructively for MIDI 141
- note attributes 206
- note durations 221
- note velocities 205, 219
- program changes 210
- Shuffle mode 145
- Slip mode 146
- Spot mode 146
- tempo events 228
- waveforms 138
- Editing Preferences
  - Auto-Name Memory Locations While Playing option 238
  - Auto-Name Separated Regions option 176
  - Conversion Quality option 126
  - Crossfade Preference for Pre/Post-Roll option 251
  - QuickPunch Crossfade Length option 113
  - Region List Selection Follows Track Selection option 143, 169
  - Separate Region Operates On All Related Takes option 95, 176
  - Take Region Lengths That Match 95
  - Take Region Names That Match Track Names option 95
  - Track Selection Follows Region List Selection option 169
- enabling
  - automation 297
  - groups 16, 32, 64
  - MIDI input devices 102
- equal gain crossfades 249
- equal power crossfades 249, 251
- Event Edit Area 31
  - note attributes 206
- Exit command (Windows) 50
- Export MIDI command 130
- Export Region Definitions command 128
- Export Selected As Files command 127
- exporting
  - audio 127
  - audio and Output Options 127
  - audio from regions 127
  - MIDI tracks 129
    - region definitions 128, 362
    - stereo interleaved files 127
- extending selections 166
  - to adjacent tracks 167, 168
  - to include adjacent regions 166
  - to Markers and Memory Locations 166
  - to region boundaries 166
- Extensions 396
- external clock sources 279
- F**
  - Fade To End command 254
  - Fade To Start command 254
  - fade-in shapes 250
  - fade-out shapes 248
  - faders, moving during playback 291
  - fades 253
    - auto-fades 254
    - creating 253
    - creating with Smart Tool 30
    - in batches 255
    - with dither 249
  - Fades dialog 246
    - In Shape 250
    - Link option 249
    - Out Shape 248
    - Use Dither option 249
  - Fast Forward
    - incrementally 156
    - locating with 156
  - Fast Forward button 34
  - Feet.Frames command 151
  - Feet.Frames Time Scale 151
  - file formats (audio) 315
    - AIFF 315
    - MP3 317
    - QuickTime 316
    - RealAudio 316
    - SND resource 316
    - Sound Designer II 315
    - WAV 316

## File menu

- Close Session command 50
- Delete Selected Tracks command 52
- Exit command (Windows) 50
- Export MIDI command 130
- Group Selected Tracks command 65
- Import Audio/Track command
  - Macintosh 120
  - Windows 122
- Import MIDI/Track command 129
- New Session command 43
- New Track command 44, 51, 87, 105
- Open Session command 45
- Quit command (Macintosh) 50
- Rename Selected Tracks command 52
- Revert to Saved command 46
- Save Session As command 46
- Save Session command 46
- Save Session Copy In command 48

film speed 335

final mixdown 323

Find command 145

finding regions 145

freewheeling time code 342

## G

generating time code 341, 347

Go to End button 34

Grabber tool 28

- editing breakpoints with 301
- Object Grabber 164
- selecting MIDI notes with 203
- Separation Grabber 176

Grid mode 26, 146

- and moving regions 185
- Draw Grids in Edit Window option 146
- Grid Value pop-up menu 146
- Regions/Markers option 146
- setting the Grid value 186

Grid value 31, 186

Group Selected Tracks command 65

groups

- and automation editing 303
- and hidden tracks 15
- and selecting tracks 16
- changing members 65
- creating 65
- deleting 65

Edit Groups 32

enabling 16, 32, 64

Mix Groups 16

renaming 65

unlinking Edit and Mix Groups 66

Groups List 63

Groups List Key focus 36, 64

Groups pop-up menu 63

Delete Selected Groups command 64

Display command 63

New Group command 63

Suspend All Groups command 63

## H

H/W Buffer Size 76

half-screen 158

half-speed playback 118

half-speed recording 118

hard disk recording 9

hard drives

and QuickTime movies 369

recording to multiple 79

recording to system volume 80

Round Robin Allocation 79

Hardware command 39, 40

hardware I/O Inserts 268

hardware I/O Sends 271

Hardware Setup dialog 39, 40

Buffer Size 76

DAC Muting option 40

Heal Separation command 177

hidden tracks

and groups 15

and selections 162

hiding

all tracks 53

auto-created regions 198

tracks 53

Highest Priority Playback option 369

Horizontal Zoom buttons 147

## I

I/O capacity

allocating 388

and DSP usage 388

I/O Labels command 278

- I/O View 20
  - Identify Beat command 230
    - Identify Beat dialog 231
  - Identify Silence command 256
  - Identify Sync Point command 183, 363
  - Import Audio command (Macintosh) 121
  - Import Audio dialog (Macintosh) 120
  - Import Audio from Current Movie command 375
  - Import Audio From Other Movie command 125
  - Import Audio/Track command
    - Macintosh 120
    - Windows 122
  - Import MIDI command 129
  - Import MIDI/Track command 129
  - Import Movie command 370
    - Import Movie dialog 370
  - importing
    - audio 119
    - audio and Conversion Quality 126
    - audio from CDs 125
    - audio from QuickTime movies 375
    - audio into a session (Macintosh) 119
    - audio into a session (Windows) 122
    - audio with drag & drop 125
    - MIDI tracks 128
    - QuickTime movies 370
  - input connections 73
    - and digital sources 116
  - Input Devices command 102
    - Input Devices dialog 102
  - Input Filter command 103
    - MIDI Input Filter dialog 103
  - Input Only Monitoring option 76
  - Input Quantize command 104
    - Input Quantize window 104
  - Input Selector 20
  - inputs 11
    - assigning 53
    - levels 73
  - Insert controls 22
  - Insert Silence command 258
    - and Shuffle Mode 258
    - and Slip Mode 258
  - inserting
    - controller events 208
    - meter events 233
    - MIDI notes 201
    - program changes 210
    - tempo events 227
  - Inserts 268
    - adding 269
    - as a shared bus 269
    - assigning Plug-Ins 270
    - assigning to tracks 269
    - editing 270
    - for hardware I/O 268
    - for Plug-Ins 268
    - labeling 278
    - mono or stereo 269
    - on single tracks 269
    - removing 270
    - shared within a submix 280
  - Inserts View 22
  - Inserts/Sends Editor 267
    - Inserts 270
    - Sends 272
- J**
- Jam Sync 342
- K**
- keyboard focus 36
    - Audio Regions List Key focus 36, 144
    - Commands Key focus 26, 36, 390
    - Groups List Key focus 36, 64
    - MIDI Regions List Key focus 36, 144
  - keyboard shortcuts 389
    - global key commands 389
    - numeric entry 167
    - recording 88
- L**
- labeling
    - Inserts and Sends 278
  - Latch Record Enable Buttons option 75
  - latency
    - for recording and monitoring 76
  - length, for selections 165
  - level faders
    - Sends 23
    - tracks 21
  - Level Indicator 21

- level meters
  - clearing 22
  - for audio tracks 21
  - for MIDI tracks 22
  - for Sends 23
- linear crossfades 251
- Link Edit and Timeline Selection option 161
- Linked Selections button 26, 161
- Local Control 13, 103
- locating
  - with Fast Forward/Rewind 156
  - with Location Indicators 157
- Location Indicators 31, 156
  - locating with 157
- locations, for MIDI notes
  - dragging 204
  - quantizing 217
  - randomizing 217, 218
- Lock/Unlock Regions command 189
- locking regions 189
- Loop Playback option 171
  - and audio recording 94
  - and Auto Touch mode 294
- loop points 96
  - and Playback Markers 96
  - recalling with Memory Location 99
- Loop Record mode 82, 93
- loop recording
  - and pre/post-roll 93
  - audio 93
  - MIDI 109
    - drum machine style 109
    - multiple takes 110
- looping selections 171
- Low Latency Monitoring option 77
- LTC (Linear Time Code) 331

## **M**

- Machine Chases Memory Location option 353
- Machine Follows Edit Insertion/Scrub option 353
- Main Time Scale 151, 345
- managing regions 196
- Manual Tempo mode 35, 85

- Markers 236
  - creating 237
  - creating on the fly 238
  - deleting 241
  - editing 240
  - extending selections to 166
  - moving 240
  - sorting 243
  - tick-based and sample-based 236
  - viewing options 242
- Master Faders 275
  - adding 276
  - and DSP usage 388
  - as master send level control 281
- master view for tracks 135, 305
- mastering
  - digitally 323
  - to disk 323
- measures, partial 235
- Medium Priority Playback option 369
- Memory for Automation Recording option 311
- Memory Location dialog 235
- Memory Locations 235, 236
  - creating 237
  - creating on the fly 238
  - deleting 241
  - deleting all 241
  - editing 240
  - extending selections to 166
  - Markers 236
  - recalling 239
  - renaming 240
  - Selection Memory Locations 236
  - storing punch/loop points 99
- Memory Locations window 242
  - view filter 242
  - viewing options for Markers 242
- Merge mode (see MIDI Merge mode)
- Merge Paste command 195
- meter
  - current 233
  - default 84
- meter events 233
  - editing 234
  - inserting 233

- Meter Ruler
  - displaying 233
  - extending an Edit selection to 234
- MIDI 12
  - common misconceptions 14
- MIDI Beat Clock command 358
- MIDI channels 13
  - assigning 59
- MIDI clips and Regions List 143
- MIDI control surfaces 13, 267
- MIDI controller devices 13, 101
  - Local Control 13, 103
- MIDI Device/Channel Selector 20, 59, 105
- MIDI devices 13
- MIDI files (see Standard MIDI Files)
- MIDI Machine Control (MMC) 351
  - configuring in Pro Tools 352
  - controlling external devices with 351
  - remote track arming 353
  - syncing to a sequencer with 356
  - syncing to an ADAT 354
- MIDI menu
  - All Notes Off command 225
  - Change Duration command 221
  - Change Meter command 233
  - Change Tempo command 227
  - Change Velocity command 219
  - Click Options command 84
  - Input Devices command 102
  - Input Filter command 103
  - Input Quantize command 104
  - MIDI Beat Clock command 358
  - MIDI Thru option 103
  - Quantize command 214
  - Select Notes command 213
  - Split Notes command 214
  - Transpose command 222
- MIDI Merge mode 35, 82, 105
- MIDI notes
  - attributes for 31, 206
  - chasing 223
  - deleting 206
  - duplicating selected 194
  - editing 202
    - durations 221
    - pitch 203
    - velocities 205, 219
  - inserting 201
    - lengths in ticks 152
    - moving 204
    - quantizing 214
    - selecting 203, 213
    - splitting 214
    - transposing 203, 222
    - trimming start/end points 204
- MIDI offset 224
- MIDI Operations window 212
  - parameter options 212
- MIDI Preferences
  - Default Note On Velocity option 201
  - Negative MIDI Playback Offset option 224
  - Pencil Tool Resolution When Drawing Controller
    - Data option 208, 300
- MIDI recording 101
  - cancelling takes 107
  - enabling input devices 102
  - Input Filter 103
  - Merge/Replace mode 105
  - monitoring with MIDI Thru 103
  - quantizing on input 104
  - System Exclusive data 112
  - undoing a take 107
  - Wait for Note 104
- MIDI regions 139
  - and controller events 141
  - and Merge Paste command 195
  - and punch recording 108
  - guidelines for editing 140
- MIDI Regions List 33, 143
  - and MIDI clips 143
  - dragging from 178
  - finding regions 145
  - sorting 144
- MIDI Regions List Key focus 36, 144
- MIDI Regions List menu 33
  - Auto Rename Selected command 197
  - Clear Selected command 198
  - Display All command 145
  - Find command 145
  - Import MIDI command 129
  - Rename Selected command 197
  - Select Unused command 198
  - Sorting option 144
  - Time Stamp Selected command 185, 361
- MIDI Replace mode 35, 82, 105
- MIDI Thru option 103

- MIDI tracks
  - and MIDI offset 224
  - and tempo changes 229
  - assigning to multiple channels 106
  - channel strips 18
  - configuring for recording 105
  - default program change 209
  - exporting 130
  - loop recording 109
  - Merge Paste command 195
  - note chasing 223
  - Notes view 135, 139
  - punch recording 107
  - punching on the fly 108
  - record enabling 74
  - recording 101, 105
  - Regions view 135, 140
  - selecting a pitch range in 213
  - Sys Ex view 211
  - Velocity view 205
- Minimum Sync Delay option 354
- Minutes:Seconds Time Scale 150
- mix busses 271
- Mix Groups 16
- Mix Groups list 16
- Mix window 15, 17
  - track controls 18
  - track width 61
- Mix Window Shows option 15
- mixer channels 11
- mixing and DSP usage 384, 386
- mixing down to stereo 323
- MMC (see MIDI Machine Control)
- monitoring
  - during punch recording 92
  - MIDI recording with MIDI Thru 103
  - record and playback levels 76
- monitoring latency 76
- monitoring modes 75
  - Auto Input Monitoring 75
  - Input Only Monitoring 76
- Movie menu
  - Bounce to Movie command 376
  - Highest Priority Playback option 369
  - Import Audio from Current Movie command 375
  - Import Audio From Other Movie command 125
  - Import Movie command 370
  - Medium Priority Playback option 369
  - Normal Priority Playback option 369
  - Set Movie Sync Offset command 373
  - Show Movie Window command 371
- Movie Tracks 371
  - scrubbing 371
  - setting sync point 373
- Movie window 371
- movies (see QuickTime movies)
- moving
  - Bar|Beat Markers 232
  - Markers 240
  - MIDI notes 204
  - program changes 210
  - regions 182
  - sysex events 211
- Moving Faders During Playback option 291
- MP3 file format 317
- MTC (MIDI Time Code) 331
  - outputting 342
- multiple tracks
  - editing across 193
  - extending selections to 167, 168
  - pastings to 193
  - selecting 167
- MultiShell 388
- Mute automation 302
- Mute button 19, 61
- Mute Frees Voice option 60, 61
- Mute/Unmute Region command 190
- Mutes Follow Mix Groups option 60, 291
- muting
  - regions 190
  - tracks 61

## N

- Narrow Mix Window option 61
- Negative MIDI Playback Offset option 224
- network connections 396
- New Group command 63
- New Session command 43
- New Track command 44, 51, 87, 105
  - New Track dialog 87
- No Auto-Scrolling option 157
- nondestructive editing 133
  - for audio 139
  - for MIDI 141

- Nondestructive Record mode 81
  - nondestructive recording 90
    - recording to a new playlist 91
    - with QuickPunch 113
  - Normal Priority Playback option 369
  - Note Chasing option 223
  - notes (see MIDI notes)
  - Notes view 135, 139
    - mini-keyboard 139
    - scrolling up or down 140
  - Nudge value 31, 187
    - trimming regions by 182
  - nudging 186
    - by next Nudge Value 187
    - region contents 188
    - selection range 165
    - selection start/end points 165
    - selections and regions 187
    - setting the Nudge value 187
  - numeric entry
    - Calculator mode 167
    - shortcuts 167
  - Numeric Keypad modes 390
    - Classic 390
    - Shuttle 160, 391
    - Transport 391
- O**
- Object Grabber 164
    - and Edit Groups 164
  - Object selections 163
  - OMS patch names 209
  - Online button 33
  - Online option 346
  - online recording 346
  - on-the-fly punch recording
    - MIDI tracks 108
    - QuickPunch 82, 113
  - Open Ended Record Allocation option 80
  - Open Session command 45
  - Operation Preferences
    - Audio During Fast Forward/Rewind option 156
    - Auto Region Fade In/Out Length option 255
    - Edit Insertion Follows Scrub/Shuttle option 159
    - Latch Record Enable Buttons option 75
    - Machine Chases Memory Location option 353
    - Machine Follows Edit Insertion/Scrub option 353
    - Open Ended Record Allocation option 80
    - Record Online option 346
    - Use F11 for Wait for Note 104
  - Operations menu
    - Auto Input Monitoring option 75
    - Auto-Spot Regions command 360
    - Calibration Mode 74
    - Copy Edit Selection to Timeline command 173
    - Copy Timeline Selection to Edit command 173
    - Destructive Record mode 90
    - Input Only Monitoring option 76
    - Link Edit and Timeline Selection option 161
    - Loop Playback option 171
    - Loop Record mode 93
    - Low Latency Monitoring option 77
    - Mute Frees Voice option 60, 61
    - Online option 346
    - Play Edit Selection command 173
    - Play Timeline Selection command 173
    - Pre/Post Roll Playback command 98
    - Pre/Post-Fader Metering option 22
    - Scrolling Options 157
  - Original Time Stamp 185, 361
  - Other Options dialog 40, 41
  - Output Options 127, 315
    - Channels 320
    - Conversion Quality option 321
    - File Format 315
    - Resolution 320
    - Sample Rate 320
    - Use Squeezer option 320
  - Output Selector 20
  - outputs
    - assigning 54
  - overlap crossfades 251
- P**
- Page Scroll During Playback option 157
  - Pan automation 302
  - Pan Indicator 21
  - Pan Slider 21
  - Panning 59

- partial measures 235
- Paste command 192
- pasting
  - automation 306
  - between automation playlists 193
  - multiple data types 193
  - selections and regions 192
  - to multiple tracks 193
  - with Merge Paste command (MIDI) 195
  - with Repeat Paste To Fill Selection command 260
- PCI Load 311
- Peak Hold options 22
- Peak Indicator 21
- Pencil tool 28
  - as Eraser 207
  - drawing automation with 300
  - editing breakpoints with 301
  - inserting MIDI notes with 201
  - repairing waveforms with 263
  - resolution for inserted controller events 208
  - shapes 300
- Pencil Tool Resolution When Drawing Controller Data option 208, 300
- pitch, for MIDI notes
  - transposing with Grabber 203
  - transposing with Transpose command 222
- Play button 33
- Play Edit Selection command 173
- Play Timeline Selection command 173
- playback and Scrolling Options 157
- playback cursor 155
- Playback Engine 12
  - changing 41
- Playback Engine command 41
- Playback Markers 96, 161
  - and Edit selections 162
  - and selection length 165
  - and Timeline selections 172
- Playhead 158
  - and Edit selections 173
  - and Timeline selections 173
  - moving to region boundaries 173
- playing
  - and on-the-fly selections 163
  - at half-speed 118
  - Edit selections with Playhead enabled 173
  - from a track point 155
  - selections 170
  - Timeline selections with Playhead enabled 173
  - tracks 155
- Playlist Selector 25
- playlists 10, 141
  - adding new 142
  - and nondestructive MIDI editing 141
  - assigning 142
  - automation playlists 142, 287, 293
  - deleting 142
  - duplicating 142
  - edit playlists 14, 141
  - naming 69
  - recalling 142
  - recording to new 91
  - renaming 142
  - setting pre/post-roll in 98
- Plug-In Inserts 268
- Plug-Ins
  - assigning to Inserts 270
  - automating 296
- positional reference 330
- post crossfade 246
- post crossfades 252
- pre crossfade 246
- pre crossfades 252
- Pre/Post Roll Playback command 98
- Pre/Post-Fader Metering option 22
- pre/post-roll
  - and loop recording 93
  - and punch recording 92
  - auditioning 170
  - setting 97
- Pre/Post-Roll Flags 98, 161
- printing effects to disk 282
- Pro Tools 24 systems 5
  - auto-fades 254
  - file management 67



- Pro Tools III systems 5
  - 24-bit input and output 324
  - file management 67
  - importing audio 119, 121
  - voice management 57
- Pro Tools LE 7
- Pro Tools MIX systems 5
  - 24-bit input and output 324
  - auto-fades 254
  - file management 67
  - pre/post-roll 97
  - QuickPunch 114
- Pro Tools TDM 6
- processing bandwidth 311
- Program Change window 209
- program changes 13, 208
  - and bank select 208
  - auditioning 210
  - chasing 224
  - default, for MIDI tracks 209
  - deleting 210
  - editing 210
  - inserting 210
  - moving 210
  - patch names 209
- Pull Up/Down 335
  - 3:2 Pulldown 334
  - configuring 345
- punch points 96
  - and Playback Markers 96
  - recalling with Memory Location 99
- punch recording
  - and monitoring 92
  - and pre/post-roll 92
  - audio 92
  - MIDI 107
  - MIDI on the fly 108

## Q

- Quantize command 214
  - experimenting with 218
  - Quantize window 215
- Quantize Regions command 189
  - and Grid value 186
- Quantize window 215
  - Quantize Grid 215
  - Quantize Options 216
  - What to Quantize 215

- quantizing
  - MIDI notes 214
    - attacks vs. releases 215
  - MIDI on input 104
  - regions 189
- QuickPunch 82, 113
  - crossfades 113
  - non-TDM systems 115
  - region/take numbering 116
  - TDM systems 114
- QuickPunch Crossfade Length option 113
- QuickTime file format 316
- QuickTime movies 367
  - bouncing to 376
  - conforming 368, 373
  - frame length 369
  - importing 370
  - importing audio from 375
  - offsetting 372
  - optimizing for playback 372
  - playback quality 369
  - requirements 369
  - setting start time 373
  - spotting 373
- Quit command (Macintosh) 50

## R

- randomizing
  - note durations 221
  - note locations 217
  - note velocities 220
- RealAudio file format 316
- real-time editing 133
- Record button 34, 81
- Record Enable button 18
- record enabling tracks 74
- record modes 81
  - and MIDI 82
  - Destructive Record mode 81
  - Loop Record mode 82
  - Nondestructive Record mode 81
  - QuickPunch 82
  - switching with Record button 81
- Record Online option 346
- Record Pause mode 89
- Record Safe mode 18, 75

- recording
  - a MIDI track 105
  - a single audio track 87
  - a submix to disk 282
  - additional takes 90
  - at half-speed 118
  - bouncing to disk 313
  - cancelling takes 88
  - destructively 90
  - from a digital source 116
  - from Record Pause mode 89
  - in stereo 89
  - keyboard shortcuts 88
  - monitoring latency 76
  - multiple audio tracks 89
  - non-destructively 9, 90
  - non-linear 9
  - online 346
  - System Exclusive data 112
  - to a new playlist 91
  - to multiple hard drives 79
  - to the system volume 80
  - with a countoff 83
  - with Round Robin Allocation 79
  - with the click 83
- Red Book Audio CDs 377
- region boundaries
  - extending selections to 166
  - moving edit cursor to 169
  - moving Playhead to 173
- region definitions 128, 362
- Region List Selection Follows Track Selection
  - option 143, 169
- regions 10
  - aligning to region start points 179
  - auto-created 134
  - auto-naming parameters 197
  - auto-spotting 360
  - capturing 175
  - clearing 191
  - consolidating 196
  - copying 191
  - creating 175
  - crossfading between 251
  - cutting 191
  - default names 78
  - deleting underlying 192
  - displaying all 145
  - displaying names 137
  - displaying times 137
  - dragging from Regions List 178
  - duplicating 194
  - exporting as audio files 127
  - extending selections to include 166
  - finding 145
  - healing separations 177
  - hiding auto-created 198
  - inserting silence into 258
  - locking 189
  - managing 196
  - moving 182
  - moving in Grid mode 186
  - muting 190
  - naming 69
  - nudging 187
  - Original Time Stamp 185
  - pasting 192
  - placing at Edit insertion point 178
  - placing in tracks 178
  - quantizing 189
  - removing unused 198
  - renaming 196
  - repeating 195
  - replacing 261
  - selecting 162
  - selecting all in a track 163
  - separating 175
  - separating with Separation Grabber 176
  - shifting 188
  - shuffling 183
  - slipping 184
  - sorting 144
  - spotting 184, 360
  - spotting to movies 374
  - sync points 182, 362
  - time stamping 361
  - trimming by Nudge Value 182
  - trimming start/end points 180
  - trimming to Edit insertion point 181
  - trimming unwanted data from 177
  - User Time Stamp 185
  - user-defined 134, 196, 198
  - whole-file audio regions 134
- Regions view 135, 140
- related takes 94
  - and Separate Region command 95
  - preferences for 95
- remote track arming 353

- Remove Sync Point command 183
- removing
  - crossfades 252
  - Inserts 270
  - Sends 271
  - sync points 363
- Rename Selected command 197
- Rename Selected Tracks command 52
- renaming
  - auto-created regions 196
  - groups 65
  - Memory Locations 240
  - playlists 142
  - regions 196
  - tracks 78
- Repeat command 194
- Repeat Paste To Fill Selection command 260
- repeating
  - selections and regions 195
- Replace mode
- Replace Regions command 261
  - Replace Regions dialog 261
- resolving sync 364
- Return to Zero button 33
- Revert to Saved command 46
- Rewind
  - incrementally 156
  - locating with 156
- Rewind button 33
- Round Robin Allocation 79
- Ruler View Shows option 150
- Rulers
  - changing display order 150
  - Conductor Rulers 149
  - displaying all 150
  - scrolling in 157
  - Timebase Rulers 149
  - zooming in 148

**S**

- sample delays (see DSP delays)
- sample rate conversion quality 126, 375
- sample rate formats 320
  - custom 320
- Samples Time Scale 151
- Save Session As command 46
- Save Session command 46
- Save Session Copy In command 47, 48
- scaling note velocities 205, 220
- screen savers 396
- Scroll After Playback option 157
- scrolling
  - in the Ruler 157
  - Notes view up or down 140
- Scrub Trimmer 181
- Scrubber tool 28, 158
  - in Shuttle mode 159
  - selecting with 169
- scrubbing 158
  - a single audio track 159
  - and edit cursor 159
  - in Shuttle Lock mode 160
  - Movie Tracks 371
  - on two audio tracks 159
  - playback speed and direction 159
  - resolution 159
  - with Scrub Trimmer 181
  - with the Selector 159
- SCSI
  - ID 395
- Select All command 163
- Select Notes command 213
  - Select Notes window 213
- Select Unused Regions command 198
- selecting
  - a pitch range of notes 213
  - across multiple tracks 167
  - all regions in a track 163
  - all regions in all tracks 163
  - discontiguous regions 163
  - during playback 163
  - grouped tracks 16, 32
  - MIDI notes 203, 213
  - notes in a chord 213
  - on all tracks 168
  - regions 162
  - track material 162
  - with Scrubber 169
  - with Selection Indicators 166
- Selection Indicators 31, 166
  - and numeric entry shortcuts 167
  - making selections with 166
- Selection Memory Location 236
  - moving stored selection 240

- selections
  - and Edit Groups 162
  - and hidden tracks 162
  - and Playback Markers 162
  - auditioning start/end points 170
  - changing length of 165
  - clearing 191
  - consolidating 196
  - copying 191
  - cutting 191
  - discontiguous 163
  - duplicating 194
  - extending 166
  - extending to the Meter Ruler 234
  - extending to the Tempo Ruler 229, 241
  - including Conductor Rulers 168
  - looping 171
  - moving to adjacent tracks 168
  - moving to the next/previous region 169
  - nudging 165, 187
  - nudging start/end points 165
  - Object 163
  - on-the-fly 163
  - pasting 192
  - playing 170
  - removing a track from 168
  - repeating 195
  - shifting 188
  - storing with Memory Locations 236
  - useful techniques 169
- Selector tool 28
  - scrubbing with 159
  - selecting MIDI notes with 203
- Send controls 22
  - showing 45
- Send level faders 23
- Send level meters 23
- Send mute 23
- Send pan 23
- Sends 271
  - adding 271
  - and DSP usage 387
  - assigning to tracks 272
  - automating 295
  - Auxiliary Returns 274
  - copying track automation to 295
  - displaying 271
  - displaying controls for 23, 272
  - editing 272
    - for hardware I/O 271
    - for mix busses 271
    - labeling 278
    - mono or stereo 271
    - removing 271
- Sends View 22
- Sends View Shows option 271
- Separate Region command 175
  - and related takes 95
- Separate Region Operates On All Related Takes
  - option 95, 176
- Separation Grabber 176
- Session Setup window 340
  - Current TC 363
- session templates 48
- sessions 10
  - bit depth 44, 340
  - closing 50
  - creating 42
  - default tempo 230
  - frame rate 341
  - opening 45
  - sample rate 340
  - saving 46
  - start frame 341
- Set Movie Sync Offset command 373
- Setups menu
  - Disk Allocation command 79
  - Feet.Frames command 151
  - Hardware command 39, 40
  - I/O Labels command 278
  - Playback Engine command 41
- Shift command 188
  - Shift dialog 188
- Show Disk Names option 143
- Show File Names option 143
- Show Full Pathnames option 143
- Show Meters in Sends View option 273
- Show MIDI Operations command 212
- Show Movie Window command 371
- Show/Hide Tracks list 15
- Shuffle mode 26, 145
  - and locked regions 189
  - and moving regions 183
- Shuttle Lock mode 160
- Shuttle, Numeric Keypad mode 160, 391

- Slip mode 26, 146
  - and moving regions 184
- Smart Tool 29
  - and audio tracks 29
  - and MIDI tracks 30
  - creating crossfades with 30
  - creating fades with 30
  - editing automation with 30
  - editing controller events with 30
- Smooth and Thin Data After Pass option 292, 299
- smoothing automation 292
- SMPTE
  - configuration 343
  - frame formats 332
  - start frame for session 341
- SMPTE Slave Driver (SSD) 340
  - generating time code with 347
- snapshot automation 308
  - adding to empty automation playlists 309
  - and trim values 310
  - writing over existing automation 309
- SND resource file format 316
- Solo button 18, 60
- Solo Safe mode 19, 61
- soloing
  - tracks 61
  - tracks in a submix 280
- Solos Follow Mix Groups option 60, 292
- sorting
  - Markers 243
  - regions 144
- Sorting option 144
- Sound Designer II file format 315
- Split Notes command 214
  - Split Notes dialog 214
- Spot dialog 184, 359
  - Use Subframes option 359, 361
  - User Time Stamp button 361
- Spot mode 26, 146, 358
  - and moving regions 184
  - trimming regions in 360
- spotting
  - auto-spotting 360
  - QuickTime movies 373
  - regions 184, 358, 360
- Standard MIDI Files 128
  - exporting 129
  - importing 128
  - Type 0 128
  - Type 1 128
- Standard Trimmer 180
- start frame, for sessions 341
- stepped control automation 302
- stereo interleaved files, exporting 127
- stereo recording 89
- Stop button 33
- Strip Silence command 256
  - and region naming 257
  - Strip Silence dialog 256
- stuck notes 225
- Sub Time Scale 151, 345
- subframes 359
- submixes 280
  - applying an Insert to 280
  - bouncing to 322
  - bouncing to disk 282
  - soloing tracks in 280
- Suspend All Groups command 63
- suspending automation 297
- swing 216, 218
- sync 329
  - 3:2 Pulldown 334
  - and film 333
  - Bi-Phase/Tach 332
  - black burst 364
  - film speed vs. video speed 335
  - guide tracks 334
  - LTC 331
  - MIDI Beat Clock 358
  - MMC 351
  - options 339
  - positional reference 330
  - Pull Up/Down 335
  - resolving 364
  - SMPTE frame formats 332
  - time code 330
  - troubleshooting 363
  - VITC 331
- Sync Mode 341
- Sync Offset 342
- sync points 362
  - for QuickTime movie 373
  - for regions 182
  - identifying 183, 363

syncing to a sequencer

Macintosh 349

Windows 351

with MMC 356

syncing to an ADAT 354

Sys Ex view 211

System Exclusive data 13, 211

and MIDI Thru 103

deleting 211

moving 211

recording 112

System Load 311

## T

Take Region Lengths That Match option 95

Take Region Names That Match Track Names  
option 95

takes

auditioning 94

auditioning from Takes List 94

default names 78

numbering for QuickPunch 116

recording additional 90

Takes List pop-up menu 94

tapping in the tempo 86

TDM 383

TDM Mixer Plug-Ins 283

switching 284

TDM Plug-Ins

and DSP usage 388

MultiShell 388

TDM systems 5

audio interfaces 6

pre/post-roll 97

QuickPunch 114

voice and track limits 6

tempo

current 227

default 85, 230

effects on Markers and Memory Locations 236

effects on MIDI and audio 229

Manual Tempo mode 85

tapping in 86

tempo events 227

and Bar|Beat Markers 232

editing 228

inserting 227

tempo map

from Identify Beat command 230

Tempo Ruler

displaying 227

extending an Edit selection to 229, 241

Thin Automation command 299

thinning automation 293, 299

tick-based and sample-based 236

tick-based timing 152

time code 330

and Jam Sync 342

capturing 359

freewheeling 342

generating 341, 347

Time Code Time Scale 150

Time Scale 150

Main 151, 345

Sub 151, 345

Time Stamp Selected command 95, 185, 361

Time Trimmer 258

Timebase Rulers 149

and selecting on all tracks 168

and Timeline selections 172

Edit Markers 162

Playback Markers 161

Pre/Post-Roll Flags 161

sliding Edit selections 169

sliding Timeline selections 172

Timeline selections 171

and Playback Markers 172

auditioning with Playhead enabled 173

copied from Edit selection 173

copied to Edit selection 173

in Timebase Rulers 172

sliding in the Ruler 172

start, end, and length fields 34

tools 27

Touch Timeout option 292

track controls

Edit window 23

Mix window 18

showing 45

track data 134

Track Height 25, 136

track level faders 21

- track level meters 21
- Track Name/Comments dialog 44, 78
- Track Selection Follows Region List Selection option 169
- Track Transfer™ utility software 128
- track width 61
- tracks 11
  - adding to selection 167, 168
  - adding to session 44, 51
  - and Record Safe mode 75
  - appending new material to end of 91
  - assigning inputs 53
  - assigning outputs 54
  - assigning Sends 272
  - color coding 62
  - deleting 52
  - Display Format 25, 134
  - grouping 62
  - hiding 53
  - locating with Fast Forward/Rewind 156
  - master view 135, 305
  - moving selections between 168
  - muting 61
  - names 22, 78
  - placing regions in 178
  - playback priority 56
  - playing 155
  - record enabling 74
  - removing from a selection 168
  - renaming 52
  - selecting across multiple 167
  - selecting all regions in 163
  - selecting all regions in all tracks 163
  - selecting material in 162
  - selecting on all 168
  - soloing 61
  - Track Height 25, 136
  - transferring between sessions 128
  - transposing 222
  - trimming unwanted data from 177
  - virtual tracks 11, 14, 54
- Transport Master 353
- Transport window 33
  - MIDI controls 35
  - pre/post-roll 34, 98
  - start, end, and length fields 34, 97
  - transport controls 33
- Transport, Numeric Keypad mode 391
- Transpose command 222
  - Transpose window 222
- transposing 222
  - by octave 223
  - key 223
  - MIDI notes 203
  - tracks 222
- Trim Automation command 311
- Trim End To Insertion command 182
- Trim Start To Insertion command 182
- Trim To Selection command 177
- Trimmer tool 27, 180
  - Scrub Trimmer 181
  - Time Trimmer 258
- trimming
  - automation breakpoints 302, 307
  - crossfades 252
  - input sum levels 285
  - note start/end points 204
  - region start/end points 180
  - regions by Nudge Value 182
  - regions to Edit insertion point 181
  - regions with Scrub Trimmer 181
  - unwanted region and track data 177
- Tweak-head setting 321

**U**

- Undo and MIDI recording 107
- Universal Slave Driver (USD) 339
  - and VSO
  - generating time code with 348
  - resolving with 340
  - sync options 340
- unlinked Edit and Timeline selection 161
- Use F11 for Wait for Note option 104
- Use Squeezer option 320
- Use Subframes option 359, 361
- User Time Stamp 185, 362
- user-defined regions 134, 196, 198

## V

- Variable Speed Override 343
- velocities, for MIDI notes
  - default for inserted 201
  - dragging velocity stalks 205
  - drawing with Pencil 205
  - editing 205, 219
  - fading 220
  - randomizing 220
  - scaling 220
  - scaling with Trimmer 205
- Velocity view 205
- Vertical Zoom buttons 147
- video capture/playback cards 368
- video speed 335
- views
  - Comments View 23
  - I/O View 20
  - Inserts View 22
  - Sends View 22
- Virtual Memory 396
- virtual tracks 11, 14, 54
- VITC (Vertical Interval Time Code) 331
- Voice Selector 19
- voices 11, 19
  - allocating 14, 55
  - and track priority 56
  - auto-assignment of ascending 55
- Volume automation 302
- VSO (see Variable Speed Override)

## W

- Wait for Note 35, 104
- WAV file format 68, 316
  - AES31/Broadcast compliant 68
- Waveform view 25, 134, 137
- waveforms 137
  - and zero-crossing 138
  - avoiding clicks and pops 138
  - drawn rectified 137
  - guidelines for editing 138
  - repairing with Pencil tool 263
- whole-file audio regions 134
- Write Automation command 308, 310
- Write to Start/All/End buttons 306

## writing

- automation 294
- automation to start, end, or all 306
- snapshot automation 308

## Z

- zero-crossing 138
- Zoom buttons 26
- Zoom Preset buttons 27, 149
- Zoomer tool 27, 148
- zooming 147
  - a track area 148
  - all the way out 148
  - around a track point 148
  - horizontally for all tracks 147
  - in the Ruler 148
  - recalling zoom levels 149
  - storing zoom levels 149
  - vertically for all audio tracks 147
  - vertically for all MIDI tracks 147